

TRADITIONAL JAVANESE RESIDENTIAL ARCHITECTURE DESIGNS AND THERMAL COMFORT

A Study Using a Computational Fluid Dynamics Program to Explore,
Analyse, and Learn from the Traditional Designs for Thermal Comfort

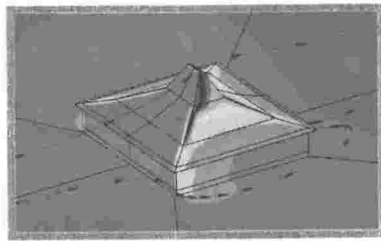

by
Prasasto Satwiko

A thesis
submitted to the Victoria University of Wellington
in fulfilment of the
requirements for the degree of
Doctor of Philosophy

Victoria University of Wellington
1999

Abstract

This thesis grows out of a desire to understand, in building science terms, the environmental features of traditional building design practices on Yogyakarta Special Region (Indonesia). The construction of traditional dwellings conforms to a set of rules, determining both the form and process of construction.

The thesis describes tests of a number of factors related to traditional Javanese buildings for their effect on thermal comfort and air flow, isolating those design aspects and analysing them through contemporary techniques.

Having proposed a scientific rationale behind traditional customs, two building styles, *Joglo* and *Limasan* are analysed. These styles are shown to relate to traditional numerological systems (*petungan*; i.e. *sri and kitri*), which have governed the specific details of domestic construction, and to the scale and siting of structures within the designated traditional guidelines. For comparison, simple hip-roofed dwelling (not applying Javanese style, *petungan*, and materials), representing current practices, were modelled.

A commercial Computational Fluid Dynamics program was used as the principal research tool, testing thermal comfort through computer simulation.

The main conclusion reached by this thesis is that traditionally designed Javanese architecture is thermally comfortable in a hot humid climate, more so than the simple hip-roofed dwelling. Literature studies reveal that modern building science ideas on thermal comfort in hot humid climates had been applied instinctively in traditional Javanese architecture. Computer simulation confirms them as thermally comfortable.

Differences in style, *petungan* values, and scale were found to affect thermal comfort slightly, through their effects on the aerodynamic and thermal performance of the buildings. On the other hand, factors relating to materials have a significant effect on thermal comfort. The high porosity of traditional clay tile roof systems has provided Javanese buildings with a continuous ventilated roof, which is superior to corrugated steel from the point of view of ventilation of the dwellings.

In addition, CFD modelling has proved to be a valid means of testing airflow within and around buildings. However, calibration is needed to ensure the CFD program performs accurately and reliably. Simplification of data input is also recommended to minimise complication in the simulation without necessarily sacrificing the accuracy of the results. Further applications and current limitations of CFD technology are discussed.

Contents

Abstract	i
Contents	ii
Biography	vii
Figures	viii
Tables	xii
Nomenclature	xiv
Glossary	xvi
Pronunciation of Javanese words	xviii
Acknowledgements	xix
1 INTRODUCTION	
1.1 Background	1-1
1.1.1 Architectural Issues	1-1
1.1.2 Buildings Science Issues	1-4
1.1.3 Computer Issues	1-7
1.2 The Hypothesis and the Research Question	1-10
1.3 Aims and Objectives	1-10
1.4 Limitations	1-11
1.5 Synopsis	1-11
2 RESEARCH DESIGN	
2.1 Introduction	2-1
2.2 Overview	2-1
2.3 Experiment	2-5
2.4 Procedures	2-5
2.4.1 Sub-procedure for Calibration	2-7
2.4.2 Sub-procedure for Experiment of Javanese Building Aerodynamics	2-9
2.4.3 Sub-procedure for Experiment of Javanese Building Thermal Performance	2-9
2.5 Preparation	2-10
2.6 Analysis and Assessments	2-10
2.6.1 Analysis and Assessment of the Experiment for Calibration	2-11
2.6.2 Analysis and Assessment of the Experiment for Javanese Building Aerodynamic Performance	2-12
2.6.3 Analysis and Assessment of the Experiment for Javanese Building Thermal Comfort Performance	2-12
2.7 Interpreting Results and Evaluation	2-13
2.8 Scenarios	2-13
2.9 Summary	2-14

3 YOGYAKARTA SPECIAL REGION

3.1	Introduction	3-1
3.2	Region	3-1
3.3	Urban, Suburban, and Rural	3-2
3.4	Topography	3-5
3.5	Climate	3-5
3.5.1	Wind Directions and Velocities	3-5
3.5.2	Rain and Humidity	3-16
3.5.3	Air Temperatures	3-16
3.5.4	Solar Radiation	3-17
3.6	Population	3-19
3.7	Housing	3-19
3.8	Culture	3-20
3.9	Summary	3-22

4 JAVANESE ARCHITECTURE

4.1	Introduction	4-1
4.2	Javanese Architecture in General	4-1
4.3	Styles in Javanese Architecture	4-3
4.4	Javanese Architecture and Orders	4-19
4.4.1	<i>Petungan</i> in Javanese Architecture	4-19
4.4.2	Targets of <i>Petungan</i>	4-20
4.4.3	Units and Modules in <i>Petungan</i>	4-20
4.4.4	Application of <i>Petungan</i> on Roofs	4-22
4.4.5	Application of <i>Petungan</i> on the Main Frame	4-23
4.4.6	Application of <i>Petungan</i> on Walls	4-24
4.4.7	Application of <i>Petungan</i> on Floors	4-25
4.5	Summary	4-27

5 JAVANESE RESIDENTIAL BUILDINGS

5.1	Introduction	5-1
5.2	Styles	5-2
5.3	Traditional Building Design and Orders	5-3
5.4	Landscape	5-3
5.5	Building	5-7
5.5.1	Building Mass and Plan	5-7
5.5.2	Orientation	5-10

5.5.3	Roofs	5-11
5.5.4	Structures	5-14
5.5.5	Walls	5-15
5.5.6	Floors	5-21
5.6	Furnishing	5-24
5.7	Summary	5-25

6 JAVANESE RESIDENTIAL BUILDING AND THERMAL COMFORT

6.1	Introduction	6-1
6.2	Hot Humid Tropical Building Designs	6-2
6.3	Theoretical Review of Aerodynamics and Thermal Performance of Javanese Buildings	6-16
6.3.1	General and Specific (<i>Petungan</i>) Guides and Javanese Building Forms	6-16
6.3.2	Interrelationship among Javanese Building Forms, Materials, Aerodynamics and Heat Transfers	6-19
6.3.3	Javanese Building and Indoor Thermal Comfort	6-29
6.4	Indoor Thermal Comfort and the Occupants' Zones	6-30
6.4.1	The Six Related Aspects	6-30
6.4.2	Occupants' Behaviours	6-31
6.4.3	Sources of Heat and Water Vapour	6-35
6.4.4	Occupants' Zones	6-36
6.5	Summary	6-37

7 COMPUTATIONAL FLUID DYNAMICS SOFTWARE AND THE INDOOR THERMAL PERFORMANCE OF JAVANESE RESIDENTIAL BUILDING

7.1	Introduction	7-1
7.2	Computational Fluid Dynamics Software – Main	7-1
7.2.1	Validation Issues	7-1
7.2.2	User-friendliness Issues	7-5
7.2.3	Data Input Issues	7-7
7.3	Indoor Thermal Comfort Performance of Javanese Residential Building and CFD Codes	7-9
7.3.1	Effect of Building Forms	7-9
7.3.2	Effect of Material Properties	7-9
7.4	Expected Difficulties in Analysing and Developing Indoor Thermal Comfort using Computational Fluid Dynamics Software	7-10
7.4.1	Architects and Building Environmental Designs	7-10
7.4.2	Converting Real Building Data into Computer Input Data	7-11

7.4.3	Program Sensitivity	7-13
7.5	Program Selection	7-13
7.6	The CFD-ACE Program	7-13
7.7	Summary	7-14

8 CALIBRATION OF THE EXPERIMENTAL TOOLS – THE PHYSICAL AND COMPUTER MODELS

8.1	Introduction	8-1
8.2	Experiment for Aerodynamic Calibration Preparation	8-2
8.2.1	Data of Building and Wind Tunnel Model	8-2
8.2.2	Experiment Preparation	8-3
8.2.2.1	Wind Tunnel Experiment	8-4
8.2.2.2	CFD Experiment	8-4
8.2.3	The Experiment	8-12
8.2.3.1	Preliminary Trial and Error	8-12
8.2.3.2	The Main Experiment	8-15
8.2.4	Results and Discussions	8-16
8.3	Experiment for Thermal Calibration	8-21
8.3.1	Data of the Model	8-21
8.3.2	Experiment Preparation	8-22
8.3.3	The Experiment	8-23
8.3.3.1	Preliminary trial and errors	8-24
8.3.3.2	The main experiment	8-24
8.3.4	Results and Discussions	8-24
8.4	Correlation between Data Input and Results	8-26
8.4.1	Air Temperatures	8-27
8.4.2	Airflow Patterns and Velocities	8-27
8.4.3	Air Humidity	8-27
8.4.4	Optimised Input Data	8-27
8.5	Summary	8-28

9 JAVANESE BUILDINGS AND AERODYNAMIC PERFORMANCE

9.1	Introduction	9-1
9.2	Model Selection	9-1
9.3	Geometry	9-2
9.4	Boundary Condition	9-4
9.5	Flow Domain	9-6

9.6	The Experiment	9-6
9.7	General Findings and Discussions	9-21
9.8	Javanese Building Design and Aerodynamic Performance	9-23
9.9	The Performance of Computational Fluid Dynamic Program	9-24
9.10	Summary	9-25

10 JAVANESE BUILDINGS AND THERMAL COMFORT PERFORMANCE

10.1	Introduction	10-1
10.2	Model Selection	10-1
10.3	Geometry	10-2
10.4	Boundary Condition	10-5
10.5	Flow Domain	10-6
10.6	Assessment Tool	10-6
10.7	Experiment on the Effect of Solar Radiation on the Clay Tiles' Temperatures	10-8
10.8	Experiment on the Thermal Performance of Javanese Buildings	10-10
10.9	Relating the Experimental Results to Indoor Thermal Comfort	10-18
10.9.1	Air Temperatures	10-18
10.9.2	Airflow Patterns and Velocities	10-19
10.9.3	Predicted Mean Vote and Predicted Percentage of Dissatisfied	10-19
10.9.4	Air Humidity	10-20
10.10	Javanese Building with Partitions	10-20
10.11	The Performance of Computational Fluid Dynamic Program	10-21
10.12	Summary	10-21

11 CONCLUSIONS

11.1	Introduction	11-1
11.2	Main Question on Javanese Building Design and Thermal Comfort Performance	11-1
11.3	Subsidiary Questions	11-2
11.3.1	The Unique Forms of Javanese Buildings and Thermal Comfort	11-2
11.3.2	The Unique Materials of Javanese Buildings and Thermal Comfort	11-3
11.3.3	Modelling Simplification and Simulation Accuracy	11-4
11.4	Recommendations	11-5

Appendix A

A.1	The Ten Buildings	A-1
A.2	The Six Related Aspects of Thermal Comfort	A-8
A.3	Simple Thermal Comfort Evaluation	A-10

Appendix B

Bibliography

Biography

Prasasto Satwiko was born on May 1, 1959 as the third child of Pragnjono and Sriati Soedjiko. He graduated from Universitas Gajah Mada Yogyakarta as an architect in 1984 and worked in practical and educational fields. Work as a consultant involved him in the design of private dwellings, housing projects, and offices. He writes books and publishes his articles in national and international journals and newspapers. He has lectured part-time at Widya Mataram University and Duta Wacana Christian University.

His wife, Nurani Tedjowati, is a chemical engineer with Biro Lingkungan Hidup (the Environment Office). Her interest in environmental issues has encouraged Prasasto Satwiko to focus on corresponding issues in architecture. The present development of computer technology has challenged him to step further towards building environmental performance simulation. Currently they have two sons: Kidung Ageng and Renung Kinanthi.

In 1994, Prasasto Satwiko finished his Master of Building Science degree from the School of Architecture, Victoria University of Wellington with First Class Honours. He is currently a lecturer at Atma Jaya Yogyakarta University, Yogyakarta.

Figures

Chapter 1
(no figures)

Chapter 2
Figure 2-1 Sketch of the relationships between the case study, tool and experiment
Figure 2-2 Sketch of the case study
Figure 2-3 Flow chart of the research design

Chapter 3
Figure 3-1 Indonesian archipelago
Figure 3-2 Yogyakarta Special Region
Figure 3-3 Yogyakarta downtown with colonial buildings
Figure 3-4 Wind direction and their frequencies from January 1981 to December 1994
Figure 3-5 Wind speed graphs
Figure 3-6 Air temperature, humidity and rainfall from January 1981 to December 1994
Figure 3-7 Average air temperature, humidity, rainfall and wind speed from January 1981 to December 1987
Figure 3-8 Linear fitted graphs of air temperature, humidity, and rainfall
Figure 3-9 Average air temperature and humidity from January 1981 to December 1981
Figure 3-10 Average air temperature and humidity from January 1985 to December 1985
Figure 3-11 Average air temperature, humidity, rainfall and sunshine from January 1987 to December 1987
Figure 3-12 Twenty-four hours recording of air temperature and humidity on 5 November 1996 with a short period of rain
Figure 3-13 Twenty-four hours recording of air temperature and humidity in a clear day, 6 November 1996
Figure 3-14 Seven days recording of air temperature and humidity inside a *Limasan sri* used as a *dalem*
Figure 3-15 Correlations between climatic factors
Figure 3-16 Averaged percentages of solar radiation received by a plane on the ground

Chapter 4
Figure 4-1 Javanese human dimension applied to Leonardo da Vinci's Vitruvian man
Figure 4-2 Sectors
Figure 4-3 The five basic forms
Figure 4-4 Parts of Javanese building structure
Figure 4-5 Four-five method
Figure 4-6 Four-nine method
Figure 4-7 Examples of some different forms with the same spiritual values
Figure 4-8 Examples of some similar forms with different spiritual values

Chapter 5
Figure 5-1 The basic configuration of a Javanese building
Figure 5-2 A typical complex of a Javanese building
Figure 5-3 Redundant construction of *tumpang sari*
Figure 5-4 A typical scene of Javanese buildings in the villages
Figure 5-5 A current typical condition of Javanese buildings in the city
Figure 5-6 A common view of kampong in Yogyakarta
Figure 5-7 Trees as a wind barrier

- Figure 5-8 The wide and high canopy trees create a corridor for horizontal wind and screen from the sun direct radiation
- Figure 5-9 Covered and un-covered ground can result in different temperature above it
- Figure 5-10 Sheltered court
- Figure 5-11 Wide beds
- Figure 5-12 Linens cover *senhongs* as visual barriers
- Figure 5-13 Difficulty in rearranging the room
- Figure 5-14 A gap between *dalem* and *gandhok*
- Figure 5-15 A closed gap between *dalem* and *gandhok*
- Figure 5-16 Glass tiles are common to give a bit of light
- Figure 5-17 *Limasan trajumas lambang gantung*
- Figure 5-18 Common roof materials: clay tiles, bamboo, timber and randomly inserted glass tiles
- Figure 5-19 Common type of windows on thick walls with steel bars
- Figure 5-20 Common type of windows on timber plank walls with bars
- Figure 5-21 Ornamented walls
- Figure 5-22 Typical openings in rural bamboo houses
- Figure 5-23 Typical of internal doors. No door leaves
- Figure 5-24 Elevated floor system found in Borobudur temple, central Java
- Figure 5-25 The Indonesian style house found on the Ongbah cave cylinder
- Figure 5-26 A house in Pakem which applies elevated floor system by raising the ground level
- Figure 5-27 A Sundanese house, west Java, applies an on-stilts floor system
- Figure 5-28 Malay house with an on-stilts system
- Figure 5-29 Common conditions of floors
- Figure 5-30 An effort to update *dalem*
- Chapter 6
- Figure 6-1 The occupants' zone
- Chapter 7
- Figure 7-1 Variety of disciplines in computational fluid dynamics
- Chapter 8
- Figure 8-1 Direction agreement
- Figure 8-2 A box in a box
- Figure 8-2 Atmospheric boundary layer wind profile
- Figure 8-3 Uniform wind flow profile
- Figure 8-4 Average C_p differences (relative to the field data, leeward)
- Figure 8-5 Average C_p differences (relative to the field data, windward)
- Figure 8-6 C_p max. differences (relative to the field data, leeward)
- Figure 8-7 Inlet/outlet C_p differences (between cases and field data)
- Figure 8-8 C_p max. differences (relative to the field data, windward)
- Figure 8-9 Horizontal temperature differences
- Figure 8-10 Vertical temperature differences
- Figure 8-11 Grid design of the Texas Tech experimental building model
- Figure 8-12 Pressure distribution on the surfaces of Texas Tech. experimental building based on 3D-case3
- Figure 8-13 Non-dimensional temperature plot in a square with $Ra=10^5$
- Figure 8-14 Non-dimensional temperature plot in a two-dimensional vertical square with $Ra=10^5$
- Figure 8-15 Grid design for the enclosed cavity
- Figure 8-16 Grid design for the two-dimensional square
- Figure 8-17 Non-dimensional temperature plot in an enclosed cavity and the horizontal mid-plane

- Figure 8-18 Non-dimensional temperature plot in an enclosed cavity and the vertical mid-plane
- Figure 8-19 Non-dimensional temperature plot in the enclosed cavity
- Figure 8-20 Non-dimensional temperature plot at the horizontal mid-plane
- Figure 8-21 Non-dimensional temperature plot at the vertical mid-plane
- Figure 8-22 Iso non-dimensional temperature surface
- Figure 8-23 Vectors inside the enclosed cavity
- Chapter 9
- Figure 9-1 Atmospheric boundary layer
- Figure 9-2 *Joglo kitri* (small version)
- Figure 9-3 *Limasan sri* (small version)
- Figure 9-4 Hipped roof #2 (small version)
- Figure 9-5 *Joglo kitri* (large version)
- Figure 9-6 *Limasan sri* (large version)
- Figure 9-7 Hipped roof #2 (large version)
- Figure 9-8 Comparison of Pressure Coefficient difference (ΔC_p) at roof level
- Figure 9-9 Comparison of Pressure Coefficient difference (ΔC_p) at between roof and wall level
- Figure 9-10 Airstream around a *Joglo kitri* building (large version)
- Figure 9-11 Airstream around a 34° hipped roof (#2)
- Figure 9-12 Airstream around a 26° hipped roof
- Figure 9-13 The grid design of a *Joglo kitri* model
- Figure 9-14 Pressure coefficient plot on the surfaces of a *Joglo kitri* (front view)
- Figure 9-15 Pressure coefficient plot on the surfaces of a *Limasan sri* (front view)
- Figure 9-16 Pressure coefficient plot on the surfaces of a hipped roof (front view)
- Figure 9-17 Pressure coefficient plot of *Joglo kitri* (rear view)
- Figure 9-18 Pressure coefficient plot of *Limasan sri* (rear view)
- Figure 9-19 Pressure coefficient plot of a hipped roof (rear view)
- Figure 9-20 Vectors showing the backward airflow behind the *guru* sector of *Joglo kitri*
- Figure 9-21 Vectors showing the change of airflow from backward flow
- Figure 9-22 Vectors showing the backward airflow at the leeward side of a hipped roof
- Figure 9-23 Vectors showing the backward airflow at the leeward side of a hipped roof
- Figure 9-24 Comparison of air velocity distribution around small version models
- Figure 9-25 Comparison of air velocity distribution around large version models
- Figure 9-26 Vectors around small version models
- Figure 9-27 Vectors around large version models
- Figure 9-28 Comparison of pressure coefficient C_p plots on the roof surfaces
- Chapter 10
- Figure 10-1 Comparison of Indoor Air Temperature (°C)
- Figure 10-2 Comparison of Indoor Air Velocity (m/s)
- Figure 10-3 Comparison of Predicted Mean Values
- Figure 10-4 Comparison of Predicted Percentage of Dissatisfied (%)
- Figure 10-5 Comparison of indoor air temperature distribution in small version models
- Figure 10-6 Comparison of air temperature distribution at 120 cm above the floor
- Figure 10-7 Comparison of Predicted Mean Votes (PMV) distribution at 120 cm above the floor.
- Figure 10-8 Area of various Predicted Percentage of Dissatisfied (PPD) in *Joglo sri* under an average climate condition (Scenario)
- Figure 10-9 *Joglo kitri* with partition
- Figure 10-10 Air temperature distribution inside *Joglo kitri*
- Figure 10-11 Air temperature distribution inside *Joglo kitri*
- Figure 10-12 Air velocity distribution inside *Joglo kitri*, 10 cm above the floor
- Figure 10-13 Air velocity distribution inside *Joglo kitri*, 10 cm above the floor

- Figure 10-14 Air velocity distribution inside *Joglo kitri*, 120 cm above the floor
 Figure 10-15 Air velocity distribution inside *Joglo kitri*, 210 cm above the floor
 Figure 10-16 Predicted Mean Vote inside *Joglo kitri* for a person wearing short and T-shirt
 Figure 10-17 Predicted Mean Vote inside *Joglo kitri* for a person wearing trousers and a long sleeve shirt
 Figure 10-18 Airstream inside *Joglo kitri*, at 10 cm above the floor
 Figure 10-19 Airstream inside *Joglo kitri*, at 120 cm above the floor
 Figure 10-20 An example of dust particle tracing inside *Joglo kitri*, from the main door to the window of *senhong kiwa*

Chapter 11

- Figure 11-1 Comparison of Predicted Mean Vote (PMV)
 Figure 11-2 Comparison of pressure coefficient (C_p) distribution at roof surfaces of *Joglo kitri* (S) and the hipped roof building (S).

Appendix A

- Figure A-1 Data recording at Sukabsir's *pendapa* from 20 December to 25 December 1996
 Figure A-2 An example of an evaluation to the scenario seen at Table A-3

The pieces of the old Javanese manuscript, which are used in chapter covers, are from *Serat Centhini III*. Its copy and translation was found in Wiryatmaja, S., 1986, Pengetahuan Bangunan Rumah Tradisional Jawa (Pengetahuan Kalang), Departemen Pendidikan dan Kebudayaan - Direktorat Jendral Kebudayaan, Proyek Penelitian dan Pengkajian Kebudayaan Nusantara (Javanologi), pp.145-161.

Tables

Chapter 1 (no tables)	
Chapter 2 (no tables)	
Chapter 3	
Table 3-1	Population and density in Yogyakarta Special Region
Table 3-2	Housing condition in Yogyakarta Special Region (as at mid-1996)
Chapter 4	
Table 4-1	Styles and their variants
Table 4-2	Forms of Javanese buildings
Table 4-3	Name and meaning of units in <i>petungan</i>
Table 4-4	Dimensions of sectors and their p values
Chapter 5	
Table 5-1	Material properties
Chapter 6	
Table 6-1	General features of hot humid climate and the Yogyakarta Special Region
Table 6-2	Hot humid climate building designs guidelines and Javanese customs and architecture guidelines
Table 6-3	Hot humid climate building designs guidelines for roof, walls, floors, and Javanese architecture
Table 6-4	Prediction of the influence of Javanese architectural orders to indoor thermal comfort factors
Table 6-5	Heat transfer process between the human body and its surroundings
Table 6-6	Assumption of the Link
Table 6-7	Summary of thermal comfort standards and of conditions found in Yogyakarta Special Regions
Table 6-8	Old and modern scenarios of activities inside the buildings
Table 6-9	Metabolic rate of different activities
Table 6-10	Thermal resistance of clothing ensembles
Table 6-11	Old and modern scenarios of clothing
Table 6-12	Scenario
Chapter 7	
Table 7-1	Performance criteria of design tool at different stages of design
Table 7-2	Strength and weaknesses of CFD
Chapter 8	
Table 8-1	Values of gradient height, power law exponents and roughness height
Table 8-2	The cases of aerodynamic calibration
Table 8-3	The rank
Table 8-4	The cases of thermal calibration
Chapter 9	
Table 9-1	Scenario
Table 9-2	The models
Table 9-3	Dimension of models

Table 9-4	Models of Javanese buildings and important points (generated by CFD-GEOM)
Table 9-5	Items of observation
Table 9-6	Comparison between <i>Joglo</i> , <i>Limasan</i> and the Hipped roof; small version
Table 9-7	Comparison between <i>Joglo</i> , <i>Limasan</i> and the Hipped roof; large version
Table 9-8	Comparison between 26° (#1) and 34° (#2) hipped roofs (large and small versions)
Chapter 10	
Table 10-1	Models for experiments of the effect of solar radiation on clay tiles
Table 10-2	Models for experiments of the thermal performance of Javanese buildings
Table 10-3	Roof pitch, in °
Table 10-4	Interior and exterior models
Table 10-5	Interior models of Javanese buildings
Table 10-6	Roof temperatures from experiment, $I = 540 \text{ W/m}^2$
Table 10-7	Scenario
Table 10-8	Comparison of the small versions
Chapter 11	
(no tables)	
Appendix A	
Table A-1	Conditions of the ten Javanese buildings
Table A-2	Climatic data in <i>pendapa</i> and <i>dalem</i>
Table A-3	An example of data for a simple thermal comfort evaluation
Appendix B	The Commercial Computational Fluid Dynamics Package (survey in 1996)

Nomenclature

A	surface area (m^2)
C_p	pressure coefficient
C_{res}	respiratory convective heat exchange (W/m^2)
E_C	evaporative heat exchange at the skin, when the person experiences a sensation of neutrality (W/m^2)
E_{res}	respiratory evaporative heat exchange (W/m^2)
f_o	surface (or film) conductance ($W/m^2\text{ }^\circ\text{C}$)
f_{cl}	clothing area factor; the ratio of the surface area of the clothed body to the surface area of the naked body
Gr	Grashof number; it is a dimensionless number being the ratio of the buoyancy forces to the viscous forces used in modelling free convection flow.
g	gravitation (m/s^2)
H	dry heat loss; heat loss from the body surface through convection, radiation and conduction
h	the height of a given point (m)
h_{bl}	gradient height; the height of the boundary layer (m)
h	height of the enclosure (m)
I	solar radiation intensity (W/m^2)
I_{cl}	clothing insulation ($m^2\text{ }^\circ\text{C}/W$)
K	turbulent kinetic energy (m^2/s^2 or J/kg)
L	reference length (m)
M	metabolic rate (W/m^2)
P	static pressure (Pa or N/m^2)
P_o	reference pressure (Pa or N/m^2)
Pr	Prandtl number; it is a dimensionless number being the ratio of the kinematic viscosity of a fluid to its thermal diffusivity used in modelling free convection flow.
PMV	Predicted Mean Vote
PPD	Predicted Percentage of Dissatisfied (%)
p_a	humidity, partial water vapour pressure (Pa)
Q_c	conduction heat flow rate (W)
Ra	Rayleigh number; it is the product of Grashof and Prandtl numbers.
R_a	air to air resistance ($m^2\text{ }^\circ\text{C}/W$)
RH	roughness height (m)
T	surface temperature (K or $^\circ\text{C}$)
T_{sk}	skin temperature ($^\circ\text{C}$)
t_a	air temperature ($^\circ\text{C}$)
t_{cl}	clothing surface temperature ($^\circ\text{C}$)
t_r	Mean Radiant Temperature ($^\circ\text{C}$)
t_o	initial surface temperature ($^\circ\text{C}$)
U	transmittance ($W/m^2\text{ }^\circ\text{C}$)
u', v', w'	velocity fluctuations (m/s)
V_{ar}	relative mean air velocity; the air velocity relative to the occupant, including body movement (m/s)
V_h	wind speed at the height of a given point (m/s)
V_{bl}	gradient speed, the wind speed at the height of boundary layer (m/s)
v	velocity (m/s)
$W_{e,}$	effective mechanical power (W/m^2)
α	absorptivity
α	mean speed exponent
β	air volumetric expansion

ΔT	temperature difference
ϵ	turbulent dissipation rate (m^2/s^3 or $J/kg.s$)
ϵ	eddy viscosity ($\epsilon = \rho l^2 \partial u / \partial y$)
θ	surface's angle to a plane perpendicular to the sun radiation
$\cos \theta$	cosine of surface' angle
λ	constant (~ 0.005)
μ	dynamic viscosity ($\mu = \tau h / V$ (kg/ms))
ν	kinematics viscosity ($\nu = \mu / \rho$ (m^2/s))
ρ	density; the amount of the material contained in a given volume (kg/m^3)
τ	shear stress ($\tau = F/A$ (kg/m^2))

Glossary

- Ander*, king post
atap kampung, gable roof, pitched roof
atap limasan, hipped roof
atap panggang pe, mono pitched roof, skillion roof
atap tajug, pyramid roof
blandar pamanjang, long beam
blandar panyelak, short beam
boundary layers, the layer of fluid in the immediate vicinity of a bounding surface; In aerodynamics the boundary-layer thickness is measured from the surface to an arbitrarily chosen point, e.g., where the velocity is 99 percent of the stream velocity.
dudur, hip
dalem, also called *omah buri*, a house or building to live in
gandhok, pavilion
guru sector, the inner-most sector of a Javanese building; it is bounded by *saka guru*
kawruh kalang, traditional knowledge of Javanese architecture
laminar flow, flow in which layers of fluid move smoothly over or alongside adjacent layers
longkangan, courts, a narrow space between buildings
Modern scientific aspects, things that relate to and can be explained by formal sciences which are based on theoretical and analytical approaches; from the Indonesian view point, modern sciences often mean sciences developed by western nations.
molo, ridge
omah, a house complex, in Javanese term *omah* is a house complex containing some buildings or masses (for *pawon*, *gandhok*, rice barn, pet stalls, etc.). *Dalem* or *omah buri* is a building to house a family.
omah buri, (see *dalem*)
(Passive) thermal comfort; comfort performance of buildings which are created by thermal and aerodynamics designs of buildings and rely on natural phenomena (such as the sun and wind).
pananggap sector, sector circumscribes *guru sector* in a Javanese building
panitih sector, sector circumscribes *pananggap sector* in a Javanese building
pawon, kitchen
pendapa, a building (usually with no walls), placed in front of *dalem* and used as a semi public space
peringgitan, a space between *pendapa* and *dalem* to perform leather puppets shows
petungan, Javanese numerology
primbon, books including various topics, such as recipes, but which also contain some guidelines for buildings
regol, gates
saka guru, main posts in *guru sector*
saka pananggap, main posts in *pananggap sector*
saka panitih, main posts in *panitih sector*
serat centhini, Javanese literature works
specific heat, the amount of heat necessary to raise the temperature of unit mass of material by one degree (J/kgK)
streamline, an imaginary line drawn in the fluid such that there is no flow across it any point
sumur, shallow well
traditional Javanese architecture design, architectural design that applies rules based on Javanese beliefs, which have a more *spiritual* than a physical approach. For many people, these rules are regarded almost superstitiously. The rules are mainly based on principles found in such old Javanese literature as *Serat Centhini*, *Primbon* and *Kawruh kalang*. This research defines *Javanese architecture* as traditional architecture found in the Yogyakarta Special Region
turbulent, a three dimensional time-dependent motion in which vortex stretching causes velocity

fluctuations to spread to all wavelengths between a minimum determined by viscous forces and a maximum determined by the boundary conditions of the flow (It is the usual state of fluid except at low Reynolds numbers.)

usuk, rafters

viscosity, the stickiness of a fluid and its tendency to resist sliding between layers or a rate of change of shear strain

Pronunciation of Javanese words

Pronunciation in Javanese

a	= a in <i>all</i>
<u>a</u>	= u in <i>until</i>
i	= ee in <i>tree</i>
u	= oo in <i>too</i>
e	= e in <i>permanent</i>
é	= a in <i>pay</i>
o	= o in <i>over</i>
d	= th in <i>the</i>
dh	= d in <i>detail</i>
t	= t in <i>tea</i> (without explosion)
th	= t with an explosion of the tongue from the mouth ceiling
ng	= ng in <i>bang</i>
ngg	= ng in <i>mango</i>
i + consonant	= é (a in <i>pay</i>)
o + consonant	= a in <i>always</i>
u + consonant	= o in <i>over</i>

Sometimes in a text a and a, also e and é, are not distinguished such as in the following words:

Written:	pronounced:
<i>Asta</i>	<i><u>a</u>sta</i>
<i>Dalem</i>	<i>da<u>l</u>em</i>
<i>Kampung</i>	<i>ka<u>m</u>pong</i>
<i>Limasan</i>	<i>li<u>m</u>asa<u>n</u></i>
<i>Pananggap</i>	<i>pa<u>n</u>ang<u>g</u>ap</i>
<i>Panggung pe</i>	<i>pa<u>ng</u>ga<u>ng</u> pé</i>
<i>Panitih</i>	<i>pa<u>n</u>it<u>i</u>h</i>
<i>Pecak</i>	<i>pe<u>c</u>ak</i>
<i>Pendapa</i>	<i>pe<u>n</u>d<u>h</u>apa</i>
<i>Petungan</i>	<i>pe<u>t</u>u<u>ng</u>a<u>n</u></i>
<i>Pokah</i>	<i>po<u>k</u>a<u>h</u></i>
<i>Pringgitan</i>	<i>pr<u>i</u>ng<u>g</u>it<u>a</u>n</i>
<i>Tengah</i>	<i>te<u>n</u>ga<u>h</u></i>
<i>Tajug</i>	<i>ta<u>j</u>u<u>g</u></i>

Acknowledgements

Having finished my thesis, I look back to my past, down the long path I have walked on, and realise that so many people have contributed to my work. I would like to thank those persons, without whom this thesis would probably have never been finished.

All of the architectural students of Universitas Atma Jaya Yogyakarta, for their spirit and genuine support which encouraged me to make my first step to start this thesis.

My supervisors:

Dr George Baird and Michael R. Donn

The Rector of Universitas Atma Jaya Yogyakarta and staff

Head of the School of Architecture, Victoria University of Wellington and staff

The Dean of the Fakultas Teknik - Universitas Atma Jaya Yogyakarta and staff

The Chair person of the Jurusan Teknik Arsitektur - Fakultas Teknik - Universitas Atma Jaya Yogyakarta

Financial supporters:

Atma Jaya Yogyakarta University and the Internal Grant Committee, Scholarship Office of Victoria University of Wellington

School of Architecture Technicians:

Peter Ramutenas, Peter Wood, Paul Hillier, Kevin Cook, David Eyles, Arthur Mahon and others

The writers of books on Javanese architecture:

Ir. Josef Prijotomo, MArch

Drs. Hamzuri

Dr Ir Arya Ronald, IAI (also as an initial consultant)

CFD assistants:

Kiran, Perry, and Richard of CFD Research Corporation for on-line assistance

CFDRC company for providing me the research license of the CFD-ACE

Dr. D. Paterson, Dr. Y. Li of CSIRO

Data providers:

Nick Locke (Opus International Consultants Limited)

Kantor Pusat Statistik Daerah Istimewa Yogyakarta

Badan Meteorologi dan Geofisik – Lapangan Udara Adi Sucipto

Dr. A.J Baker (University of Tennessee, Knoxville)

Wind Engineering Research Centre - Texas Tech. University

Nurhadi (Balai Arkeologi Daerah Istimewa Yogyakarta)

Drs. Putu Surya Darma, M.S.

All of the School of Architecture administrative staff:

Nicky Dowle, Sandra France, Sarita Gilbertson, Margaret Smith, Elizabeth McKelvey and others

Field assistants:

Indra, Siska, Lilik, Radix, Tono, Eni

Javanese building owners (or house-sitters):

Bpk. Hadi Prasetyo, Ibu Hadi Suyitno, Bpk. Sukabsir, Bpk. Gotri, Ibu Dwi Putranti, Bpk. Djadi,

Bpk. Sukiman, Bpk. Dalijo, Ibu. Samsi Wardani, Bpk. Soesilo

My colleagues:

Ir. Yoseph Krismiyanto, Ir. Ign. Purwanto Hadi MUP, Ir. Arif Kusumawanto MT., S. Felasari S.T. and partner.

Initial statistical assistant:

Dr. Peter Smith, ISOR

School of Architecture Library and Victoria University of Wellington Library:
Elizabeth Russell and the staff

Special thanks to:

Andrew Charleson, Dr. Paul Walker and David Kernohan

My post-graduate colleagues:

Hany Fouad, David Jarvis, Ted Schwarz, Patricia Morgan, and Andrew Leach (as the proof reader)

Jema'at Gereja Kristen Jawa, Sawo Kembar, wilayah timur A

All other individuals and institutions who have given their support to me

Above all, I should remember my late Father who worked very hard to give me a better education. Also, my beloved Mother who never gives up praying for all her children. There seem to be no words to express their great love. Last but not least, I thank to my Brothers and Sisters, who are always supportive.



untuk mereka
yang tak pernah membiarkan hatiku sepi

rani, istriku
kidung dan renung, anakku

dan tentu saja
Yesus, sahabat sejatiku

h h h

[Faint, illegible handwritten text in a cursive script, likely a historical manuscript.]

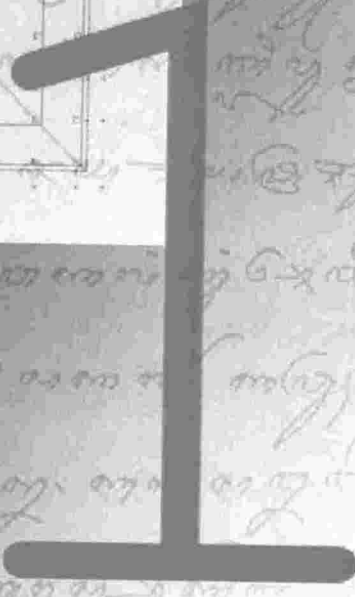
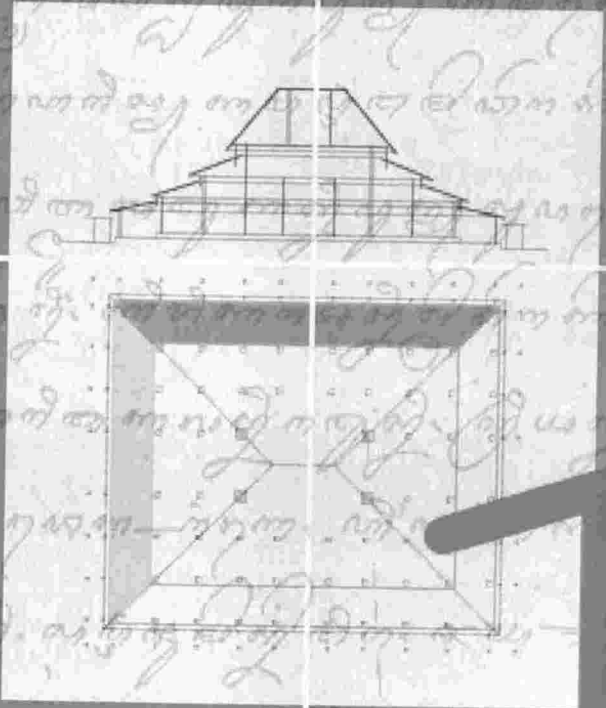

1. INTRODUCTION

1.1 Background

The basic aim of this research was to explore the passive thermal comfort performance of traditional Javanese residential buildings using a computer program as the main research tool. The approach methodology addressed architectural, building science and computing issues. These three issues revealed a range of dichotomies: old-new, traditional-modern, eastern-western, illogical-logical, metaphysical-real, and simple-sophisticated. These dichotomies cannot be avoided, as one of the objectives of the research is to link traditional - *mystical* - ideas of Javanese architecture to western - *analytical* - building science. The goal is to find an *interface* between vernacular architectural technology and modern (western) technology, allowing the survival of local architectural style and its growth into a future increasingly oriented to *hi-tech* modern life.

The physical aspects of Javanese architecture demand explanation quantitatively, not merely in the terms of traditional spiritual qualitative interpretations. With ventilation development, for example, to understand the Javanese building aerodynamics and heat transfer analytically (or scientifically) is important. Having this knowledge, development and improvement can be made in a clear (*transparent*) way.

The present situation of architecture, building science, and computing in Indonesia has both prompted and enabled this research. In the following pages the background to three questions is developed as a rationale for the research:

- ♦ The architectural issue: Why is learning from vernacular architecture important?
- ♦ The building science issue: Why is scientific study of passive thermal comfort in vernacular architecture important?
- ♦ The computing issue: Why does using a computational fluid dynamic program as the research tool give benefits? Why is optimising the data input important?

1.1.1 Architectural Issues

Over the last ten years, Indonesia has experienced a fantastic growth in building construction. New buildings with new architectural styles and technologies are being constructed. Criticisms occur. These new buildings are attacked for lacking a relationship to Indonesian cultural or

climate conditions. Calls for more *down to earth* designs, based on the local vernacular architectural heritage, have gradually increased.

Eko Budihardjo, an Indonesian architect and well-known critic, clearly states that if we are involved in the development of contemporary Indonesian architecture, we should not ignore old ideas and traditional forms.¹ We should reinterpret them into modern idioms so that the old and new blend in complete harmony. Modernisation, innovation and other developments are important. However, people should not be uprooted from their past. Budihardjo states that while the architectural heritage of developing countries might not be as grandiose as those of developed countries, the buildings are still well adapted to traditional living patterns and the local environment.² Given the often vast architectural heritage in developing countries, this assertion may seem misleading. The architectural beauty of heritage architecture is not only found in massive buildings, such as the great temples of Borobudur and Prambanan in Java, but also in smaller scale buildings, such as traditional houses.

Hasan Fathy, a prominent Egyptian architect, also believes that the architectural work of earlier generations is important.³ He wonders why modern tropical architecture uses large glass walls⁴ and recalls, in comparison, the superb aerodynamic performance of *a madyafa* (Egyptian traditional architecture).⁵

Whether vernacular architecture is thermally comfortable remains arguable. Rapoport says:

*"Lifestyle, beliefs, identity and other factors - together - may be more powerful than climatic ones in the creation of built form."*⁶

Roxana Waterson, who extensively examined the anthropology of architecture of South-East Asia, and particularly of Indonesia, writes:

*"The great variety of forms to be found in ecologically similar regions of South-east Asia is sufficient to suggest that climate, geography, or materials only dictate the outside limits to architecture design, without at all determining the end results."*⁷

Climate is not always the main consideration. As a result, one cannot expect vernacular architecture to be always climatically well adjusted or always superior to modern architecture. A recent study by Sharples and Malama, on traditional Zambian dwellings found that in cool seasons they are less comfortable than new low-cost public housing.⁸

Despite this ambiguity, it is still worth trying to learn more from vernacular architecture. Norman Pressman writes:

*“The benefits of designing with nature are not only practical but also aesthetic and sensory.... Physical environment affects behaviour and cultural norms....to ignore climates, particularly under harsh conditions, would certainly be unwise. Most vernacular design solutions have been extremely sensitive to ecological context and much can be learned from them.”*⁹

Budihardjo supports this:

*“It is quite true that we could learn much from our ancestors of how to create a harmonious and enjoyable human environment to live in.”*¹⁰

Zulficar Fathy states:

*“There is much to learn from the experience of earlier generations, gathered by centuries of trial and error, before we seek to discard this legacy for the often-illusory promise of solutions imported from the western world.”*¹¹

Dumançay, who writes on the architectural heritage of South-East Asia, notes domestic architectural heritage to be well adapted to the landscape. This gives it personality. It is good for young architects to turn back to old forms and adapt them to the needs of modern life. Only by doing this can people retain the distinctive character of regions and avoid uniformity.¹²

Xia also states the importance of understanding vernacular architecture in forming a better base for modern architecture:

*“Local traditional architecture is the most adequate and suitable answer to the requirements of environmental and energy consumption need. It is necessary to create a new architecture perspective for the next century. A deeper understanding of climate and natural components inside existing historical contexts is helpful in enhancing ecological awareness in modern building design.”*¹³

Indonesia is rich in architectural heritage. It has many ethnic groups (300 ethnic groups with 583 regional languages and dialects)¹⁴ which have developed their own architectural inflections. One of them is Javanese architecture, which evolved into unique styles guided by complicated rules called *petungan* (Javanese numerology). There have been many attempts to conserve this architectural practice. While a number of designers have been successful in

translating Javanese architecture into modern buildings, they lack deep understanding of the philosophy behind Javanese architecture. They are thus constrained to merely recalling styles in ways inappropriate to the modern situation. Despite extensive discussions on Javanese architecture, there remain many interesting aspects worth exploring. Prijotomo, an expert in this field, likens Javanese architecture to a well that will never dry up.¹⁵

Key point: By learning and taking into account what vernacular architectures have achieved, we can develop our modern architectures in a better way, culturally and environmentally.

1.1.2 Buildings Science Issues

Most of Indonesia's new buildings consume high amounts of energy in equipment to keep occupants comfortable. This has serious resource implications, as Indonesia transforms from an oil exporting into an oil importing country (projected to occur around 2005). It has even led to the controversial decision by the Indonesian government to build a nuclear power plant in Muria, East Java.¹⁶ People have begun to recognise the need for energy-efficient buildings and recognise the ability of local architecture to provide thermal comfort without using non-renewable energy.

Modernisation and globalisation have contributed to architectural chaos in Indonesia. Budihardjo has expressed this:

*"Newly industrialising countries have tended to embrace western culture as a sign of progress and grasped almost anything western without further consideration."*¹⁷

Traditional Javanese architecture has suffered from the society's readiness to accept modernisation. Dawson describes his experience:

"The aspiration of the many poor rural Javanese is to imitate the lifestyle of the Jakarta elite that they see on the television everyday.

*"In Java, the traditional house is regarded as an object of interest, to be looked upon and perhaps admired, but not to be imitated. The future lies elsewhere."*¹⁸

In terms of building science, this attitude (seeing foreign technologies as symbols of a higher status) has led to the inappropriate application of new foreign technologies to local conditions, causing comfort problems in new buildings. Failure to understand the local climate and architecture coupled with over-eagerness in applying modern technologies have introduced not only environmental problems in buildings but also an architectural identity crisis.

Indigenous people, in contrast, have developed a vernacular architecture over a long time. Local architecture results from a long process of trial and error. Its compatibility with the local climate and ability to create the thermal comfort required by occupants has stood the test of time. Rudofsky writes that many of the so-called *primitive* solutions of vernacular architecture have anticipated the cumbersome technology *invented* in recent years (air conditioning, light control, etc.).¹⁹ Frank Lloyd Wright encourages his students to enjoy the healthy world of primitive building methods.²⁰

Achieving indoor thermal comfort naturally (or passively) is not only worthwhile for energy and environment preservation but also for human well-being. Man should not be separated from nature. Richard Neutra²¹ states that the physical environment will prove more harmful to man each time we move farther away from a balanced integration with nature. Bansal's words are also useful:

"Many examples of ancient architecture have special design features that provide comfortable living conditions, without expenditure on conventional energy sources. The entire history of shelter engineering reveals an unremitting effort by mankind to achieve as high a degree of indoor comfort as possible.

*"A large number of these proven concepts of natural climatic control have been forgotten in the design of buildings today, but the depleting fuel supplies (needed for heating and cooling), the general concern for the environmental degradation and growing health problems resulting from modern buildings (sick building syndrome) have led to a renewed interest in building designs, that provide comfort mainly by natural means."*²²

In Indonesia, traditionally developed *rules* of vernacular architecture are not scientifically documented. The *blue print* is usually taught verbally through generations and underpins some *superstitious* order. For indigenous people, vernacular architecture is considered *dharma*, a social obligation engendering complete harmony between man, nature, the built environment, and God.²³ Indonesian life is full of religious activities and rituals.²⁴ Metaphysical symbolism is important to vernacular architecture and therein lies the wisdom of its designs.

For example, although the features of Javanese architecture which aid the creation of comfort have long been discussed, only very qualitative and simplified explanations of these phenomenon can be given by Indonesian architects. They have not developed Indonesian building science to a level that would enable architects to analyse local buildings scientifically.

The principles underlying the indoor thermal environmental performance of traditional Javanese architecture are technically unexplained. However, before dismissing traditional Javanese rules as irrational, it is worth noting Sukadana's argument on what is called logical thinking.²⁵ Rational thinking is a process of thinking using a certain logic. Considering that there are various kinds of logic and that they are only true under certain agreements, then what is considered true for one logic is not necessarily true for another. Various cultures from differing societies developed logic according to their diverse philosophical and epistemological backgrounds. The truth of a cultural product can only be justified based on the truth-values within that society. This is the concept of cultural relativism. Therefore, traditional Javanese architectural rules that are scientifically unexplained are not necessarily superstitious. It may simply be a matter of expressing logical thoughts in a different way.

Some scholars suspect the origin of the problem in tropical architecture (including building science) to lie in education. Most nations in the tropical climatic zones are developing countries. Johan Silas, a lecturer and highly respected Indonesian architect, points out that there is something wrong in architectural education.²⁶ Owusu Addo says most of students in these countries are unable to travel, limiting their points of reference.²⁷ They can only refer to local buildings, which are sometimes poorly designed. Most of the curricula in architectural education are adapted from western countries (particularly Great Britain and America), which have very different cultural and environmental backgrounds.

It seems that most Indonesian architects do not understand tropical architecture scientifically. Thus difficulties arise when they adapt vernacular tropical architecture to new styles. Indonesia furnishes many examples where people fail in applying modern technology, such as when an air conditioning system is installed in a traditional style building. A study by Karyono revealed that adopting the current ASHRAE standard for Jakarta would make people uncomfortably cool and waste energy.²⁸ His paper calls for a greater understanding of the true local comfort range. An earlier report by Berger warned that the prediction of thermal comfort based on commonly established procedures (which were based on studies in cold climate countries) might lead to errors when applied to tropical humid conditions.²⁹

An attempt to explain the environmental performance of Javanese architecture has been made by Setiadarma using an open-circuit wind tunnel at the School of Architecture, University of Southern California.³⁰ He found that the configurations of Javanese traditional buildings have enabled occupants to benefit from airflow. His findings are an important indication that Javanese vernacular architecture, to some degree, provides comfort (in this case through the optimisation

of wind flow) with a scientific basis. Such an approach is important, as Hasan Fathy writes:

*“The phenomena of the micro-climate must be analysed and new building materials, methods, and designs must be tested until the complex relationships among buildings, micro-climate, and human being(s) are fully understood.... Another science to which architecture is indebted is aerodynamics.”*³¹

Key point: By clearly understanding the scientific aspects of the relation between traditional architectural rules and passive thermal comfort, one can quantitatively link the potential of traditional design to the provision of passive thermal comfort in modern architectural designs.

1.1.3 Computer Issues

The architectural curricula and financial capability of most universities may be a significant hindrance in the development of Indonesian building science. Although they address building technology, most universities only include a small amount of building science in their curricula. Experts are scarce; appropriately equipped laboratories are unavailable. Fortunately, powerful computers have become increasingly available at lower prices. Building science teaching can benefit from this.

Evaluation of thermal comfort involves assessment of at least six factors: human activity levels, thermal resistance of clothing, air temperature, mean radiant temperature, air velocity and vapour pressure in ambient air.³² Since passive ventilation within buildings involves dealing with natural air movements caused by buoyancy and/or induction due to outdoor air movements, the mechanism of the process is very complicated. Air movements are very sensitive to building form details³³ and are affected by radiation from walls.

Air flows like a fluid, with laminar, transitional, and turbulent flows. Justifying whether values (air temperature, velocity, humidity, etc.) at a particular location in a building create thermal comfort is not easy. Manually calculating those values at every point within a building is almost impossible. One way to analyse ventilation performance of buildings is by using computational fluid dynamics (CFD) programs, made feasible by the present generation of powerful computers. CFD programs, based on a finite volume method, enable easier calculation and produce useful graphical results. The results are simpler to interpret as they contain not only numerical velocity values, but also graphical information on air distribution patterns.

The idea of using a computer program as a research tool is feasible because thermal comfort standards for people living in tropical climates are already well developed and

documented (e.g., Lippsmeier,³⁴ Koenigsberger,³⁵ and Kukreja³⁶). As a result, architects can begin by reviewing these comfort standards, and checking through computer simulation whether their building designs generate conditions matching those standards. The use of CFD programs should enable architects and building scientists anywhere to study the ventilation performance of buildings in any climate, provided the relevant meteorological data are available.

Considerable research has been conducted in calibrating and validating the presently sophisticated CFD programs to establish their reliability in simulating building ventilation. However, experts warn of the potential for false results caused by data input difficulties (or simplification). Depecker³⁷ using the commercial CFD program STAR-CD, stressed the need for researchers to use CFD programs carefully, especially those not designed for complex buildings. Errors in the modelling process can result from a poor fit between the mathematical model and physical object.

Krafthefer concluded that additional efforts are needed to include the effects of wall heat conduction, wall thermal mass, radiation heat exchanges, etc.³⁸ Using FLUENT v.3.02, he found that at low air velocities (in typical interior spaces), wall-fluid coupling models do not give correct values for the wall-air heat transfer coefficient. Specified wall heat flux boundary conditions were used as wall conduction and heat capacity could not be explicitly modelled. A study by Clifford, Everitt, Clarke, and Riffat also underlines the need to use CFD codes carefully.³⁹ They found that in the case of single-sided ventilation, even for the simplest geometry, CFD could produce misleading results.

Barozzi, Imbabi, Nobile and Sousa used their own CFD codes.⁴⁰ They underlined the importance of the scaling effect on some non-dimensional numbers when conducting research on the Nigerian Roof Chimney. Although this effect is particularly crucial in scaled physical models, careful attention should also be paid to this aspect of computer modelling, if seeking reliable results.

In the 1980s, personal computers became popular even though their capabilities remained very limited. Few professionals (architects and building scientists) used computer programs effectively at an early design stage, where any changes could then be made at a lower cost.⁴¹ Concerned with the unpopularity of computer aided design software, Sonderegger wrote an article in 1985 exploring the characteristics required of better building design software.⁴² He listed these properties: *high accuracy, versatility, speed, reproducibility, and ease of use*. Rather pessimistically, Boutet compared wind tunnels to computer software.⁴³ He still believed in the

superiority of wind tunnels, being more cost-beneficial, exploring a large number of factors and variables (which neither mathematics nor computers can do), were more sensitive to details, and produced reasonably accurate air movement patterns. However, that was in the 1980s. Today, it is not difficult to find building computer aided design software with the features listed by Sandergerger, thanks to more powerful computers and graphics user interface development.

Intensive development and validation of CFD software by computational fluid dynamicists (such as Awbi⁴⁴ and Baker⁴⁵) show the high potential of these programs to explore, analyse and predict buildings' environmental performance. These programs offer low operational costs, without high labour and time commitments, high levels of modelling flexibility, accuracy, precision, and can produce various kinds of results simultaneously (air temperature, velocity, humidity, pressure, pattern, etc.).

However, unlike the machines, buildings contain many poorly defined surfaces due to the heterogeneity of materials, use of complicated forms, etc. As a result, transferring real buildings' characteristics into computer codes is a very critical task. This is particularly true in analysis of an existing building. Replicating the existing building in a computer model, both comprehensively and precisely, is very difficult and can easily undermine the basic premises of using the computer for time, cost, and labour efficiency. On the other hand, over-simplifying the model can lead to false results. Hence, a balanced solution to this problem needs to be found.

Key point: By using a computational fluid dynamics program as a tool in building design research one can more economically obtain near realistic simulations.

In conclusion, there seems to be a missing link between Javanese building environmental design and modern building sciences. The lack of quantitative and scientific explanations has made Javanese building environmental performance difficult to measure in a systematic way. Applying Javanese principles to modern buildings is often uncertain and usually influenced by the builders' *romantic* ideals of comfortable old Javanese buildings. This research could be considered as a first step in explaining Javanese building environmental design, particularly its aerodynamics and thermal performance. The use of a CFD program as the main research tool is a significant advance from the currently under-developed Indonesian building science to the high technology of modern building sciences. Philosophically, this research aspires to a national architectural dignity and integrity, an Indonesian architecture deep-rooted in local architectural concepts with scientifically explainable environmental designs.

1.2 The Hypothesis and The Research Question

If architectural products represent a human response to environmental challenges, they should be developed and adapted to the climate in such a way that they become comfortable places to live. Javanese architecture, as a representation of Javanese life and a well-established culture, should be governed by the constraints which make its architectural products (residential buildings, in this case) environmentally comfortable places to inhabit.

The hypothesis: Traditional Javanese architectural practices are well founded and can be analysed, evaluated, and developed using scientific methods. The environmental performance (specifically thermal performance) of Javanese buildings is manifested physically in their construction, and thus should be explainable quantitatively using well-documented theories of aerodynamics and heat transfer.

Main question:

- How do Javanese building designs contribute to thermal comfort performance?

Subsidiary Questions:

- What is the relationship between the unique forms of Javanese architecture and thermal comfort?
- What is the relationship between the unique materials of Javanese architecture and thermal comfort?
- What modelling simplifications can be made without sacrificing the accuracy of the performance predictions based on these models?

1.3 Aims and Objectives

As mentioned at the outset, this research aims to explore the thermal comfort performance of Javanese residential buildings, using a computer simulation program.

To achieve this aim, the research targets seven principal objectives, divided into two groups:

- **Development of a thorough understanding of Javanese building designs in relation to thermal comfort.**
 1. Reviewing and summarising the physical and non-physical aspects of the Yogyakarta Special Region which might influence the environmental design of Javanese building.
 2. Exploring Javanese architecture and, in particular, the design of Javanese residential buildings.
 3. Exploring the relationship between Javanese architecture and thermal comfort, including

reviewing thermal comfort issues in warm humid climates and how Javanese building designs are respond to those issues.

- **Modelling the role of aerodynamic and thermal performances of Javanese buildings to indoor thermal comfort using a computational fluid dynamic program.**

1. Calibrating the aerodynamic and thermal simulation capabilities of the computational fluid dynamic program.
2. Simulating the aerodynamic performance of Javanese buildings.
3. Simulating the thermal performance of Javanese buildings.
4. Relating the aerodynamic and thermal performance of Javanese buildings to their indoor thermal comfort.

1.4 Limitations

Javanese architecture styles can be classified within five groups: *Tajug*, *Joglo*, *Limasan*, *Kampung* and *Panggung Pe*. Each group has many variants. Their dimensions are dictated by *petungan* (Javanese numerology). One of the most conventional *petungan* is called the four-five method: *sri*, *kitri*, *gana*, *liyu*, and *pokah*. To avoid an unmanageable experiment (there being simply too many variants of Javanese buildings), this research focuses on the basic form of *Joglo* and *Limasan* styles, which are found in Prijotomo's book.⁴⁶ Those two styles are useful as they are applied mainly to residential buildings.

The research cross-combines two types of Javanese buildings (ie. *Joglo* and *Limasan*) and two *petungan* values (ie. *sri* and *kitri*). The terms of *Joglo kitri*, *Joglo sri*, *Limasan sri*, and *Limasan kitri* are used exclusively in this research to simplify identification, and do not exist beyond these pages. *Joglo kitri*, for example, means a *Joglo* style with the *petungan* value of *kitri*.

The study focuses on the environmental performance (ie. aerodynamic and thermal) of the *Joglo* and *Limasan* styles in relation to indoor thermal comfort. While this research is based primarily on the analytical and numerical approach (using a CFD program), philosophical concepts are unavoidable, and thus described in brief to present the Javanese people's way of thinking.

1.5 Synopsis

This report follows a linear procedure of discussion, from the background to the conclusion. The overall research design is presented in Chapter Two.

To clarify the research process in achieving its aim and objectives, the thesis is structured as follows:

Chapter One backgrounds the need for this research, stating aims, objectives and the overall structure of the thesis.

Chapter Two establishes the research design, describing the general procedural aspects of the research as a whole.

Chapter Three describes and discusses both physical and non-physical aspects of the Yogyakarta Special Region. It reveals the unique relationship between climate, culture, people, and architecture.

Chapter Four explores Javanese architecture in general.

Chapter Five explores Javanese residential buildings.

Chapter Six discusses the theoretical approaches to the link between Javanese architecture and thermal comfort performance.

Chapter Seven explores the potential of computational fluid dynamics software to analyse and develop the indoor thermal performance of Javanese residential building.

Chapter Eight discusses the CFD program calibration.

Chapter Nine discusses the results of experiments designed to discover the scientific explanation of Javanese traditional architecture orders in relation to its aerodynamic performance.

Chapter Ten discusses the results of experiments designed to discover the scientific explanation of Javanese traditional architecture orders in relation to its indoor thermal comfort performance.

Chapter Eleven lists the general conclusions and recommendations of the thesis

Appendix A contains field data on the ten Javanese buildings studied.

Appendix B contains a list of experiment equipment, examples of input data for computational fluid dynamics program, and a survey of available CFD programs.

As a by-product of the research, this document includes the first comprehensive explanation of the environmental performance of Javanese buildings (see Chapter Six in particular).

Endnotes

¹ Budihardjo, E., 1990, Architectural Conservation in Bali, Yogyakarta: Gadjah Mada University Press, p.vii.

² Ibid., p.13.

³ Fathy, H., 1973, Architecture for the Poor, An Experiment in Rural Egypt, Chicago: The University of Chicago Press, p.24.

⁴ Ibid., p.26.

-
- ⁵ Ibid., p.47.
- ⁶ Rapoport, A., 1987, Learning about Settlements and Energy from Historical Precedents, *Ekistics*, vol.325 /326 /327, July-December 1987.
- ⁷ Waterson, R., 1990, The Living House - An Anthropology of Architecture in Southeast Asia, Singapore: Oxford University Press, p.73.
- ⁸ Sharples, S. and Malama, A., Thermal Performance of Traditional Housing in the Cool Season in Zambia, in Sayigh, A.A.M., ed., 1996, *Renewable Energy, Energy Efficiency and the Environment, vol.1*, World Renewable Energy Congress, 15-21 June 1996, Denver, Colorado, New York: Elsevier Science, Ltd.
- ⁹ Pressman, N., ed., 1994, Introduction: Climatic Factors in Urban Design, in Pressman, N., ed., 1994, *Architecture and Behaviour*, vol.10 (1994), no.1, pp.1-136.
- ¹⁰ Budihardjo, op.cit., p.5.
- ¹¹ _____, 1988, The Architecture of Housing, Proceeding of an International Seminar Sponsored by the Aga Khan Awards for Architecture, the African Union of Architects and the Association Architects of Tanzania held in Zanzibar, the United Republic of Tanzania 12-15 Oct. 1988, Aga Khan Award for Architecture, plaster of Paris, pp.14-15.
- ¹² Dumançay, J., 1987, The House in South East Asia, translated and edited by Smithies, Singapore: Oxford University, p.71.
- ¹³ Xia, L.J., 1996 The Bioclimatic Features of Vernacular Architecture in China, in Sayigh, A.A.M., ed., 1996, *Renewable Energy, Energy Efficiency and the Environment, vol.1*, World Renewable Energy Congress, 15-21 June 1996, Denver, Colorado, New York: Elsevier Science, Ltd, p.306.
- ¹⁴ Tagg, S., et al., 1994, Webster Concise Encyclopaedia, ver. 1.23, ____: Attica Cybernectis Ltd.
- ¹⁵ Prijotomo, J., 1995, Petungan: Sistem Ukuran dalam Arsitektur Jawa, Yogyakarta: Gadjah Mada University Press, p.1.
- ¹⁶ Local and international experts have widely and openly criticized the plan. Eventually, Indonesian government announced they would postpone this controversial project.
- ¹⁷ Prijotomo, op.cit., p.13.
- ¹⁸ Dawson, B. and Gillow, J., 1994, The Traditional Architecture of Indonesia, London: Thames and Hudson, p.84.
- ¹⁹ Rudofsky, B., 1981, Architecture without Architects, A Short Introduction to Non-Pedigreed Architecture, 5th ed., London: Academy Editions, p.viii.
- ²⁰ Blake, P., 1960, The Master Builders, New York: Knopf, p.175.
- ²¹ Simonds, J.O., 1961, Landscape Architecture, New York; McGraw-Hill, p.62.
- ²² Bansal, N.K., Hauser, G. and Minke, G., 1994, Passive Building Design - a Handbook of National Climatic Control, Amsterdam: Elsevier Science B.V., p.7.
- ²³ Budihardjo, op.cit., p.110.
- ²⁴ Dumançay, op.cit., p.14.

- ²⁵ Sukadana, A.A., 1983, Antropo-Ekologi, Surabaya: Airlangga University.
- ²⁶ _____, The Architecture of Housing, loc.cit., pp.14-15.
- ²⁷ Schreckenbach, H., (c.1984), Construction Technology for Tropical Developing Country, Eschborn: German Agency for Technical Cooperation (GTZ) for the Department of Architecture, University of Science and Technology, Kumasi, Ghana, p.9.
- ²⁸ Karyono, T.H., 1995, Thermal Comfort for the Indonesian Workers in Jakarta, Building Research Information, Nov./Dec. 1995, vol.23, no.6, p.317-323.
- ²⁹ Berger, X. and Deval, J.C., 1985, About Thermal Comfort in Humid Tropical Climates, in Fanger, P.O., ed., *Clima 2000, Vol. 4: Indoor Climate*, Copenhagen: VVS Kongres - VVS Messe, p.89.
- ³⁰ Setiadarma, E., Schiller, M. and Koenig, P., 1995, The Climatic Performance of Indonesian Traditional Architecture, a Comparison of Madurese and Javanese Architecture in Howe, R.C., Crowder, B.W., ed., 1995, 20th National Passive Solar Conference, Conference Proceeding, Minneapolis, Minnesota, July 15-20, 1995, American Solar Energy Society, plaster of Paris, pp.46-50.
- ³¹ Fathy, H., 1986, Natural Energy and Vernacular Architecture, Chicago: The University of Chicago Press.
- ³² Fanger, P.O., 1970, Thermal Comfort, Analysis and Applications in Environmental Engineering, New York: McGraw-Hill Book Company, p.25.
- ³³ Boutet, T.S., 1987, Controlling Air Movement: A Manual for Architects and Builders, New York: Mc Graw Hill.
- ³⁴ Lippsmeier, G., 1969, Building in the Tropics, Munchen: Calwey Verlag.
- ³⁵ Koenigsberger, O., Ingersol, T.G., Mayhew, A., and Szokolay, S.V., 1973, Manual of Tropical Housing and Buildings, Part 1: Climatic Design, Bombay: Orient Longman.
- ³⁶ Kukreja, C.P., 1978, Tropical Architecture, New Delhi: Tata McGraw-Hill Publishing Company Limited.
- ³⁷ Depecker, et.al., Numerical Modelling of Air Flows in Buildings and Design of Data Base Experiments, in Mitchell, J.W., and Beckman, W.A., eds., 1995, Building Simulation '95, Fourth International Conference Proceedings, August 14-16 1995, Madison, Wisconsin: International Building Performance Simulation Association, plaster of Paris, pp.97-104.
- ³⁸ Krafthefer, B., et.al., Implications of Room Air Motion on Control of Thermal Comfort in Rooms with Natural Convection Heat Sources, in Mitchell, J.W., and Beckman, W.A., eds., 1995, Building Simulation '95, Fourth International Conference Proceedings, August 14-16 1995, Madison, Wisconsin: International Building Performance Simulation Association, plaster of Paris., pp.119-127.
- ³⁹ Clifford, M.J., Everitt, P.J., Clarke, R., Riffat, S.B., Using Computational Fluid Dynamics as a Design Tool for Naturally Ventilated Buildings, Building and Environment, vol.32 (1997), no.4, pp. 305-312.
- ⁴⁰ Barozzi, G.S., Imbabi, M.S.E., Nobile E., Sousa, A.C.M., Physical and Numerical Modelling of a Solar Chimney-based Ventilation System for Buildings, Building and Environment, Vol.27, No.4, October 1992, p.439
- ⁴¹ Sonderegger, R.C., 1985, Thermal Modelling of Building as a Design Tool, in Fanger, P.O., ed., *Clima 2000: Voll: Future Perspective*, Copenhagen: VVS Kongres - VVS Messe, p.69.
- ⁴² Ibid, p.70.

⁴³ Boutet, op.cit., p.32.

⁴⁴ Awbi, H.B., 1991, Ventilation of Buildings, London: Chapman and Hall.

⁴⁵ Baker, A.J., Williams, P.T., and Kelso, R.M., 1995, Numerical Calculation of Room Air Motion-Part 3: Three-Dimensional CFD Simulation of a Full-Scale Room Air Experiment, ASHRAE Transaction, vol.100, part 2, pp.549-564.

⁴⁶ Prijotomo, J., 1995, Petungan: Sistem Ukuran dalam Arsitektur Jawa, Yogyakarta: Gadjah Mada University Press.

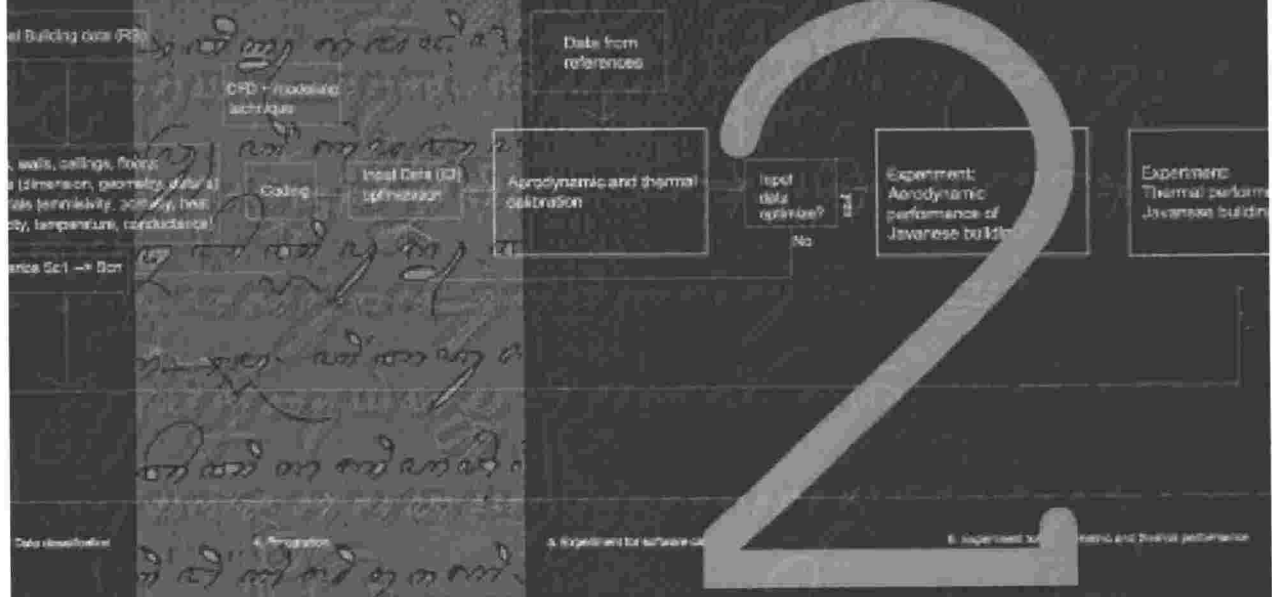
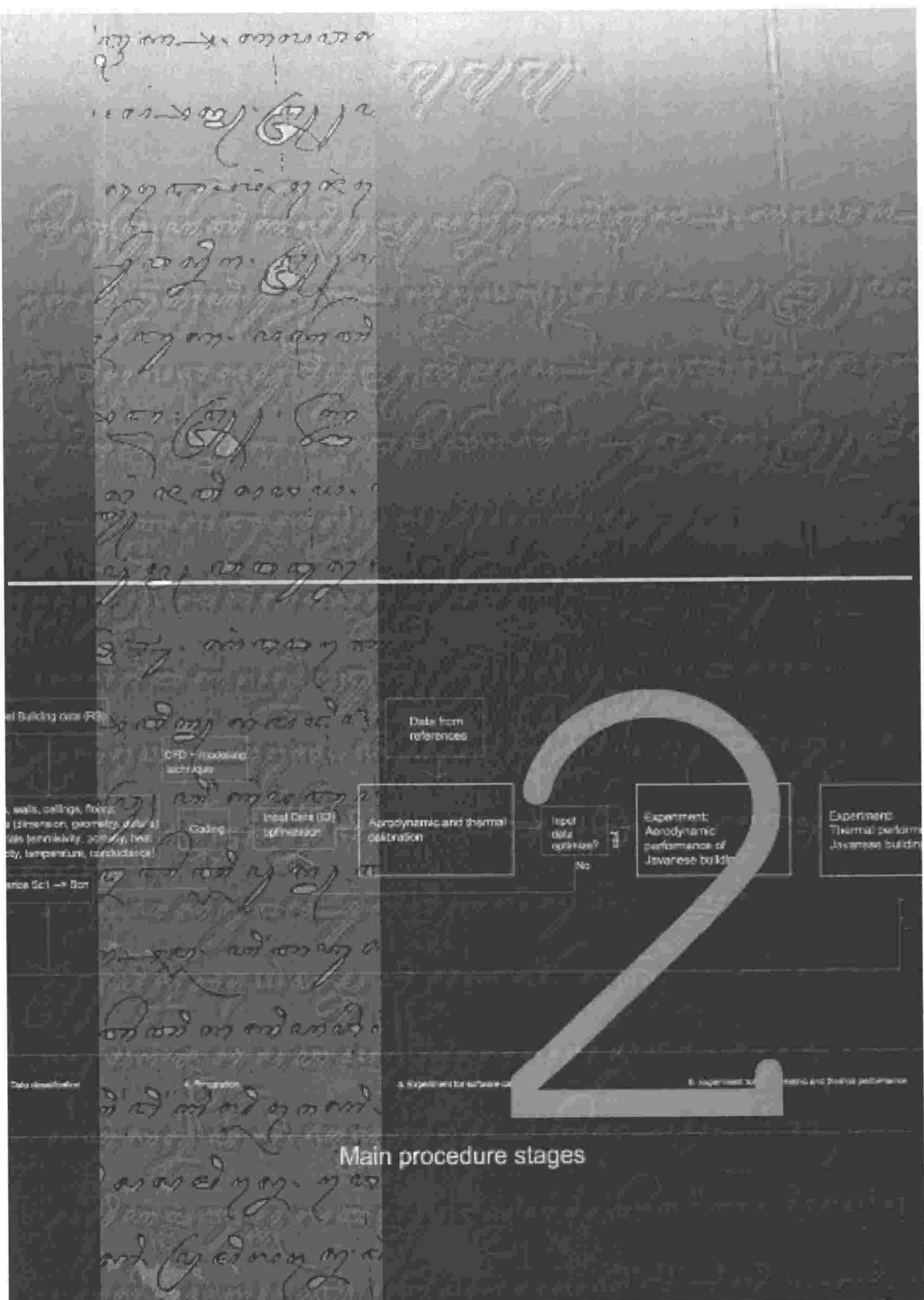

Main procedure stages

2. RESEARCH DESIGN

2.1 Introduction

This chapter discusses the research design. It provides a general scheme for all the activities carried out during this project, their interrelationships and the thoughts which led to them. Beginning with an overview, then moving to a brief description of the experiments, the discussion is advanced by a description of research procedures and preparations; and followed by the method of analysis and assessment.

2.2 Overview

As mentioned in Chapter One, the main objective of this research is to discover the contribution of Javanese building design factors to thermal comfort performance. Since the research relies on a CFD program, the main problem thus can be restated as *to discover how Javanese building designs manipulate outdoor conditions to create what Javanese people sense as a thermally comfortable indoor atmosphere, using a CFD program*. By extension, the experiment consists of three things: the environmental performance of Javanese buildings as the case study, the CFD program as the research tool, and the tool results as an explanation of the case study. Graphically, it is explained by Figure 2-1.

The case study involves four determinant groups:

- Outdoor conditions as the stimuli or challenge generator; this includes climate, topography, and vegetation.
- Javanese building as the filter or converter between outdoor and indoor conditions; this includes style, numerology, and materials.
- Indoor conditions as a result of Javanese building filtering of the outdoor condition; this includes indoor air temperature, air velocity, mean radiant temperature, and humidity.
- Occupants as the sensors of the thermal comfort level of the resulted indoor condition; this includes activities and clothing.

These four groups are all within a Javanese context. Thus, outdoor conditions are the context within which Javanese buildings exist, specifically the Yogyakarta Special Region. The occupants have their own culture influencing their lifestyle, Javanese culture. Javanese buildings have unique architectural styles. The indoor conditions are the result of Javanese building

designs manipulating the outdoor conditions which are sensed by Javanese.

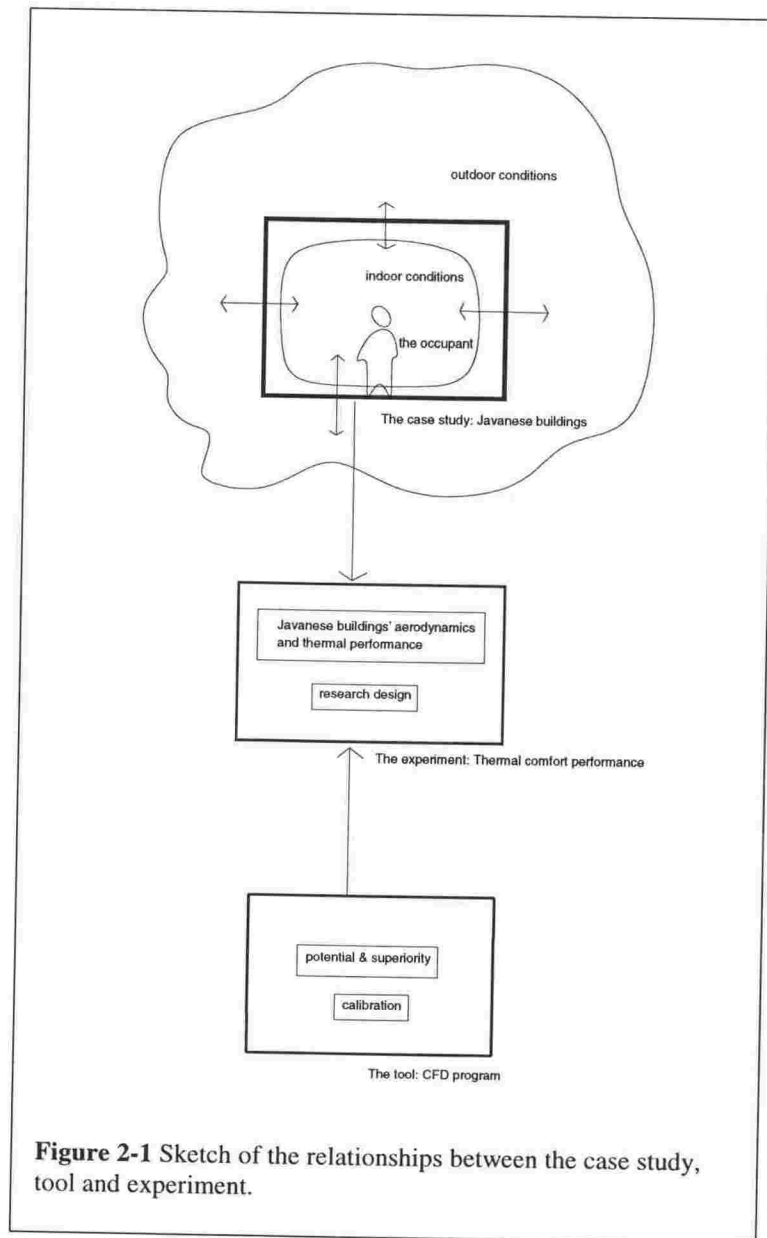

Figure 2-1 Sketch of the relationships between the case study, tool and experiment.

For clarity, detailed discussion of these four groups is presented as follows (see also sub-Chapter 1.5 Synopsis):

- The outdoor conditions of Yogyakarta Special Region are discussed in Chapter Three, which includes physical and non-physical aspects.
- Javanese buildings are discussed in three separate chapters. Chapter Four reviews Javanese architecture in general; Chapter Five focuses on Javanese residential buildings and their occupants; Chapter Six discusses theoretical approaches which link Javanese building design to thermal comfort.

The tool, a CFD program, involves two aspects: potential and reliability. For clarity, they are discussed separately in two chapters.

- The potential of the CFD program to be used as the research tool is discussed in Chapter Seven.
- The reliability of the CFD program results is confirmed through aerodynamic and thermal calibration as discussed in Chapter Eight.

The core of the research is the two main experiments in which the tool is used to explain the case study. This presents two fields of information: the experiments and the final findings or conclusion. Again, those are presented separately.

- The main experiments are considered in individual chapters: Chapter Nine for aerodynamics experiments and Chapter Ten for thermal comfort experiments.
- The overall findings are presented as conclusions in Chapter Eleven.

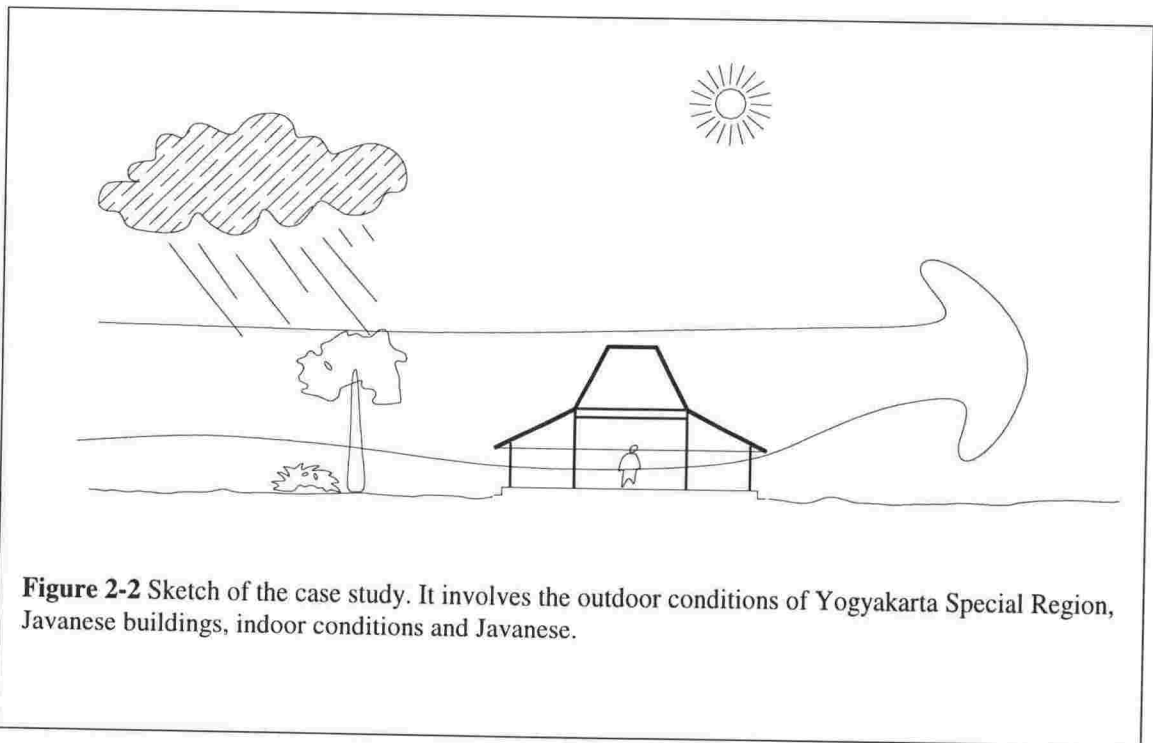

Figure 2-2 Sketch of the case study. It involves the outdoor conditions of Yogyakarta Special Region, Javanese buildings, indoor conditions and Javanese.

The main problem in reaching the research objective is how to design the research to produce unbiased results. Incorrect data, improper tools, and poorly conducted experiments generate distorted results. To simplify, the primary issue can be condensed into:

- The case study problems
 - Failure to identify local characteristics of outdoor conditions, for example, blindly applying general warm humid climate characteristics as found in textbooks, to Yogyakarta Special Region, presents a biased evaluation. Traditional Javanese buildings

developed uniquely within their own local environment. Thus, evaluation as to their environmental performance should account for the local context.

- Failure to account for the uniqueness of Javanese buildings prevents the discovery of the contribution of traditional Javanese building designs to thermal comfort. Javanese building designs combine unique factors such as style, numerology, and materials. This combination creates the buildings' unique physical properties (including geometry, dimension, and material properties) which determine their environmental performance. A thorough understanding of Javanese building designs, and particularly their effects on physical properties, is important in identifying the major and minor contributors to the buildings' environmental performance, and focuses the research to the uniqueness of Javanese building designs.
- Lack of understanding of Javanese behaviour can prejudice the evaluation of thermal comfort. Javanese buildings were developed and occupied by Javanese who have their own lifestyle (including activities and clothing). An objective thermal comfort evaluation should operate within the context of Javanese lifestyle rather than within western comfort standards.
- The tool problems
 - Poor understanding of the characteristics of the tool. This leads to incorrect results through improper use of the tool (including incorrect problem formulation, and solution methods). Every computer program is designed specifically for certain purposes. In the case of a CFD program, it is designed to solve fluid flow problems. Its reliability depends on the accuracy of data inputted, and the sophistication of the solution method. It is virtual, and has both limited and unlimited capabilities, which should be recognised for its proper use. Calibration is a suitable way to determine these limitations. Its users can thus adjust the program and obtain its best performance by minimising and maximising its negative and positive potentials.
- The experiment problems
 - Unsystematic procedures are inefficient and lack control over the experiment (leading to experiment disorientation). In the tests, well-defined case studies are inputted into a properly adjusted tool and clear procedures are followed (in the right direction of the research). A good process is also important for rapidly recognising errors (or error potential), and repairing them, while avoiding research disorientation. Eventually, the efficiency of the experiments is enhanced.

To minimise these problems, the research details the case study, reviews and calibrates the research tool, and prepares a systematic procedure for experimentation. Thus, Chapters Two to

Six are dedicated to a thorough understanding of the case study. Chapter Seven explores the potential of the tool, while Chapter Eight reports the tool calibration to ensure its accuracy; the following sub-chapters (sub-chapter 2.3 onwards) are used to build a frame-work for high quality experiments, the details of which are reported in Chapter Nine and Ten.

2.3 Experiment

This research consists of three experiments:

- **Calibration of the experimental tool.** This experiment calibrates the commercial CFD software (ie. CFD-ACE) using data from wind tunnel experiments, field measurements, and other CFD experiments. Two situations were studied: the capabilities of the software to simulate aerodynamics and heat transfer (thermal) in the building context. This experiment observed the software's validity, accuracy, and data input optimisation.
- **Simulation of the aerodynamics performance of Javanese buildings.** This experiment studied the aerodynamics of Javanese building models. It focuses on the external airflows around Javanese buildings.
- **Simulation of the thermal performance of Javanese buildings.** This experiment studied the thermal comfort within Javanese buildings.

The experiments of aerodynamics and thermal performance of Javanese buildings are deliberately separated to reduce complex computation.

The experiments apply a simulation method by using a CFD program. In this method, traditional Javanese buildings are transposed into computer models. Their aerodynamic and thermal performance under the normal (average) outdoor conditions of Yogyakarta Special Region are simulated. The characteristics of the resultant indoor air measurements are assessed using P.O. Fanger's thermal comfort standards, which have been set for Javanese conditions. Various simulations are conducted, based on given scenarios.

2.4 Procedures

The overall research design is illustrated in Figure 2-3 which shows the steps of the research. The project's steps can be categorised into either *main procedure* or smaller *sub-procedures*. The main procedure is linear. It reflects the abstract research concerns and general activities from beginning to end. The first three stages in the main procedure (theoretical and literature development, data collection, and data classification) are an integrated stage of the research basis, identifying any problems relating to the thermal performance of Javanese buildings. These three stages are intended to be independent of the subsequent stages, and able to operate as a discrete reference. Having these three stages completed allow the next to concentrate on different

subjects, specifically computational fluid dynamics and Javanese building environmental performance simulation. A sub-procedure guides an individual experiment, and depends on the subject under examination. This procedure is cyclic or repetitive until useful results can be derived. It is important to localise these individual experiments to maintain independence from the primary procedure. Experiments for calibration and for Javanese building environmental performance use local sub-procedures.

In general the main procedure consisted of eight stages:

1. **Theoretical and literature development.** A study and discussion of literature which addresses topics used as the basic theory of this research: local climates, building aerodynamics, building heat transfer, building ventilation, and thermal comfort. It provides an understanding of aspects loosely relating to building environmental performance, to baring any inter-relationship among them and focussing the issues.
2. **Data collection.** At this stage, primary (on-site measurements) and secondary data (literature) of Javanese architecture and its environment (Yogyakarta Special Region) were collected. Javanese architecture is the main subject of this research. This phase seeks a broad understanding of traditional Javanese building, its surroundings climate, thermal performance and occupants, to avoid misleading interpretation. It is, in other words, designed to understand Javanese building environmental performance in its context.
3. **Data classification.** Data is grouped for use in computer modelling and scenario development.
4. **Preparation.** This transition links the physical (real world) to virtual (computer) objects, located between the *traditional* methods of study using *pen and paper* and the highly computerised method of computational fluid dynamics (CFD). From this stage, CFD codes are studied more intensively. The aim was to understand how to reproduce the real world phenomena (ie. building aerodynamic and thermal performance) with a computer program (ie. the CFD program).
5. **Experiment for software calibration and optimised input data.** This first experiment was intended mainly to calibrate the CFD program for building aerodynamic and thermal simulation so that it may be used confidently for the main experiment. The calibration also determines the optimum input to generate the best results within the CFD program to give the best results.
6. **Experiment for Javanese building environmental performance.** As the main experiment and core of the research, the environmental performance (ie. aerodynamic and thermal performance) of Javanese buildings was explored and related to thermal comfort.
7. **Final conclusion.** The last evaluation before concluding in the output statement.

8. **Output.** The research aims to measure the thermal performance of Javanese architecture, input data optimisation, and recommend a path for development.

2.4.1 Sub-procedure for Calibration

- Selecting the case study to be modelled. At this step, a survey of texts is conducted to source reference models for aerodynamic and thermal calibration. The models consist of a real building, wind tunnel models, and CFD models with reasonable data (including the models' geometry, environmental conditions, and the setting of the CFD program).
- Defining the flow domain and boundary conditions. A CFD program simulates fluid flow within a defined domain. For external airflow simulation around buildings, the domain represents a limited volume of the external environment. The flow domain and its boundary condition should be defined in such a way to obtain realistic external wind flow, including the application of atmospheric boundary layer, and control of the direction of airflow. This definition should be based on the same data with reference models to make them comparable.
- Defining the flow properties (air temperature, humidity, density, velocity, viscosity, etc.). Definition of flow properties should be based on the reference model data, in order to make a fair comparison.
- Geometry construction. The reference models are replicated with the CFD program.
- Experiment for aerodynamic calibration. Using the models, the CFD program's aerodynamic capability is explored. This includes the adjustment to the flow domain, as well as the selection of flow solution methods.
- Experiment for thermal calibration.
- Post-processing. The CFD numerical results are converted into graphics to enhance their readability.
- Analysis. The CFD results are compared to the references and analysed to find the ideal setting of the program which is detected by its closest agreement with the field data (or CFD benchmarks).

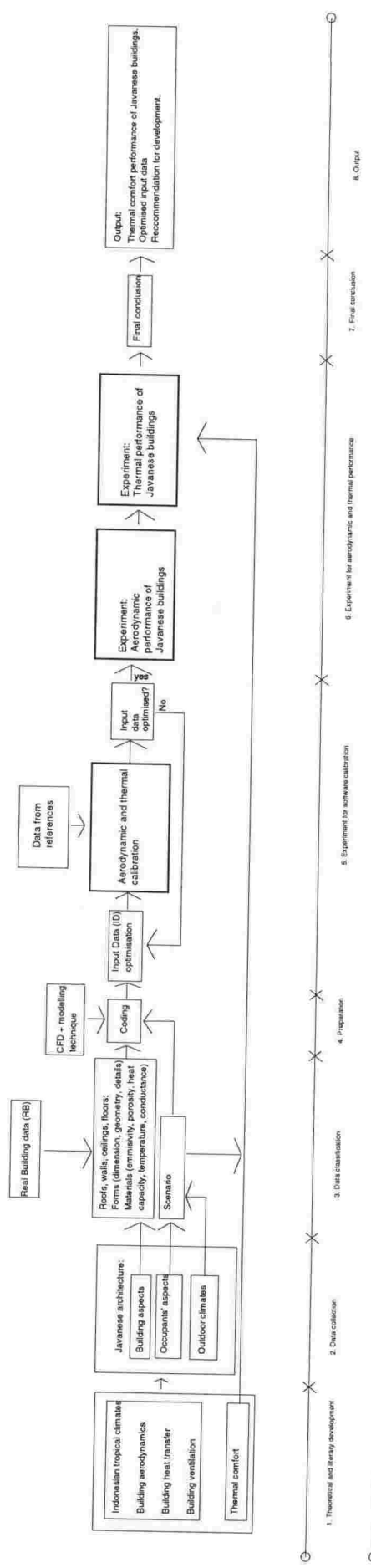

Main procedure stages

Figure 2-3 Flow chart of the research design.

2.4.2 Sub-procedure for Experiment of Javanese Building Aerodynamics

- Selecting the Javanese buildings to be modelled. Selection of the Javanese building models is based on the discussion of Javanese building designs. In selecting a limited number of Javanese buildings, relevant to thermal comfort discussion, unmanageable experiments caused by too many variables can be avoided.
- Defining the flow domain and boundary conditions. Flow domain and boundary conditions are defined according to the discussion of outdoor conditions of Yogyakarta Special Region. This ensures the models are tested under local conditions.
- Defining the flow properties (air temperature, humidity, density, velocity, etc.). Flow properties are defined as the real conditions in Yogyakarta Special Region.
- Geometry construction. The computer model of Javanese buildings is constructed, based on the discussion of Javanese building designs, including style, numerology, and scales. The models' complexity compromises between computational difficulty and the expected results. Complicated models significantly increase computational problems without guaranteeing to produce more realistic airflow.
- Experiment for external airflow. Airflow around Javanese building models is simulated.
- Post-processing. The numerical results of the CFD program are converted into graphics.
- Analysis. The aerodynamic performance of the Javanese building models, which includes airflow patterns around them and pressure coefficients on their surfaces, are analysed and compared.

2.4.3 Sub-procedure for Experiment of Javanese Building Thermal Performance

- Studying the effect of solar radiation on the clay tiles' temperatures. This is to find the temperature of roof surfaces under Yogyakarta Special Region's conditions.
- Selecting the Javanese buildings to be modelled. The selected models are simply the interior parts of the models used in the experiment for aerodynamic performance.
- Defining the flow domain and boundary conditions. Unlike the experiment for aerodynamic performance, in this procedure the flow domain is simply defined by the geometry of the buildings. The boundary conditions are defined based on discussions of the Javanese buildings and the results of solar radiation effect on the clay tiles study.
- Defining the flow properties (air temperature, humidity, density, velocity, etc.). The flow properties are defined based on the discussion of Javanese buildings.
- Geometry construction. The computer models of Javanese buildings' interiors are constructed. This includes modelling of traditional roof materials.
- Experiment for thermal performance simulation. The indoor air of Javanese buildings is simulated, and the effect of warm surfaces tested against it.

- Post-processing. The numerical results of CFD program are converted into graphics
- Analysis. The indoor air conditions of the Javanese building models are evaluated and compared to each other. This includes comparisons of air temperatures, air velocities, mean radiant temperatures, and airflow patterns. A comprehensive evaluation of thermal comfort performance is conducted using Fanger's comfort standards.

2.5 Preparation

Always conducting a pilot study and evaluating its procedure and results aids efficiency. Unrelated data can be identified and omitted in advance. Conversely, any data of possible future benefit can be allocated, even if uncollected. In this research, the preparation for each experiment is guided by findings revealed through the preceding literature study.

The research followed these preparatory steps:

- A preliminary observation to roughly identify problems in Javanese buildings. The relevant problems in Javanese buildings are identified and compiled through study of written works, field observation, and discussion with experts.
- A preliminary study on the potential of computational fluid dynamics to solve the aerodynamic and thermal problems of Javanese building. This makes sure that CFD programs have the potential to be used as a research tool in building environment experiments. It is important to determine the potential use of the research tool in advance, since every utility (whether it is software or hardware) has specific characteristics, requirements, and capabilities. A preliminary study of the CFD program is important to quickly identify its advantages and disadvantages.
- Studying existing texts to focus and localise the problems. This isolates the most relevant issues in Javanese building environmental designs which might be studied using CFD program.
- Defining the research goals. These are specified to provide the project with clear direction.
- Constructing the flow chart. This prepares the path of the research so that it can be kept in the right direction, as shown by Figure 2-3.

2.6 Analysis and Assessments

In general, for analysis and assessment, these research principles apply:

- **Qualitative analysis for secondary problems.** These include issues that should be accounted for, but should not be the major consideration. *Petungan* is full of philosophy and not be easily linked to thermal comfort scenarios. To determine the relevance of a philosophical thought to thermal comfort, a logical qualitative analysis is conducted. This

usually precedes a quantitative analysis.

- **Quantitative analysis for simple problems.** People demand different indoor air conditions to keep comfortable, depending on their activities. In many cases, recreation and behaviour are culturally determined. This kind of relationship is discussed quantitatively and checked using the ASHRAE Thermal Comfort Program.
- **Comparison with previous studies sourced in research reports for complicated numerical problems.** Computational fluid dynamics codes involve complex mathematics. Since this research focuses on the application of computational fluid dynamics codes, any issues raised by the numerical are referred to the relevant experts or, if appropriate, compared to results found in other research reports.
- **Comparison with real world conditions.** Rather than simply adjusting the computer simulation to imitate real conditions, it quickly identifies suspicious or *strange* results that may indicate the existence of flaws. These flaws can be caused by various problems from false data input to improper computer programming configuration.
- **Statistical.** Statistical analysis is used particularly for interpreting weather data. In this research SYSTAT version 5 and Corel Quattro Pro 8 software are used.

2.6.1 Analysis and Assessment of the Experiment for Calibration

To calibrate the program, the results of experiments using CFD-ACE were compared to other experiments. The reliability of the results was determined, and input adjusted to produce results reflecting real situations. The graphic comparison used Corel Quattro Pro 8 spreadsheet software. The aerodynamics and thermal calibrations used, respectively, Pressure Coefficients (C_p) and non-dimensionalised temperature as parameters.

The aerodynamic calibration compared twelve sets of data: field data¹, Selvam's wind tunnel experiments², Selvam's CFD experiments, Opus's wind tunnel³, and eight sets of CFD-ACE results from eight different experiments.

For the thermal calibration, eight sets of data were compared: Davis's two-dimensional experiment⁴, Baker's three-dimensional experiment⁵ and six sets of CFD-ACE results from six different experiments.

The tolerance range can be derived from Selvam's report. He confidently states that his CFD experiment has a good agreement with the field data. Another CFD expert, Paterson, supports this.⁶ Selvam allows up to 7% deviation for the average windward C_p difference between his CFD calculation and the real condition.⁷ In a separate case study, another CFD

expert, Shao, accepts 20% tolerance for a *good agreement* between his CFD codes' C_p results and field data.⁸

Expecting a complete match between CFD results and field data is not only difficult but also misleading. Airflows around and inside buildings are turbulent and always changing with time. Therefore, any measurements of airflow variables are generally noted as average values. CFD programs, on the other hand, tend to calculate the flow based on a particular set of steady state condition. Thus, a certain degree of deviation (between CFD results and the field data) can be tolerated.

2.6.2 Analysis and Assessment of the Experiment for Javanese Building Aerodynamic Performance

The aerodynamic performance of Javanese buildings is analysed based on the airflow patterns around the buildings and the resultant Pressure Coefficient (C_p) on their surfaces. The pressure coefficient differences (ΔC_p) on the surfaces will affect the ventilation potential of the buildings.

2.6.3 Analysis and Assessment of the Experiment for Javanese Building Thermal Comfort Performance

Fanger's comfort equations consider all indoor atmospheric and human conditions. Their comprehensiveness makes them a good assessment tool. Moreover, already in the form of equations, they are easier to integrate with CFD software, unlike graphically presented comfort standards such as psychrometric and biometric charts.

Fanger's equations generate two values: PMV (Predicted Mean Vote) and PPD (Predicted Percentage of Dissatisfied). Both offer straightforward senses of how comfortable a room is. PMV is scaled to predict thermal sensation votes on a seven-point scale *hot, warm, slightly warm, neutral, slightly cool, cool, cold*. PPD is the percentage of people who vote. On the PMV scale -3, -2, +2, +3 indicates thermal dissatisfaction.

Fanger's equations are assumed racially independent. Therefore, neutral in the PMV scale will also apply to Javanese people. However, since Fanger's comfort equations incorporate a wide range of parameters (such as the temperature of human core and the skin area) those equations might be fine-tuned to Javanese people. Chapter One suggested that applying a western originated comfort standard to Indonesian conditions might lead to incorrect conclusions. In this experiment, fine-tuning was omitted as it was sufficient to simulate cultural difference by adjusting such variables as clothing and metabolic rate (activity). Moreover,

preliminary study using the PMV equation to evaluate a scenario of ordinary comfort condition in Yogyakarta found the equation indicated a location close to 0, or neutral. (See example in Appendix A.) Thus, what Javanese people consider comfortable corresponds to the PMV scale. Fanger's comfort equations had already been modified to combine air temperature caused by convection and radiation from the warm roof.

2.7 Interpreting Results and Evaluation

Most results will be presented and interpreted graphically. Evaluation during interpretation is guided by logic informed by analysis and assessment. Any unexplained results should encourage repetition of the experiments.

Graphical presentations, plots and linear probes, are used to analyse results. Plots are defined in vertical, horizontal sections (cutting planes), or any defined surfaces. A linear probe shows the values at points (locations) in a line.

- Vector plots. These plots show the airflow patterns around and within the models, including wake formations and stagnation locations.
- Pressure Coefficient (C_p) plots. Pressure coefficient plots describe the positive and negative C_p relative to the pressure reference. These plots are useful in identifying the directions of the air (in or out) at certain locations. They are also used to calculate the ventilation potential.
- Velocity (V) plots and linear probes. Velocity plots allow for easy visual detection of low and high air velocity as well as stagnant locations. The velocity variable is used in the comfort equations to calculate the comfort level of a given location.
- Temperature (T) plots and linear probes. Temperature plots make the study of air temperature distribution easy. These plots show warmer and cooler locations within the house caused by radiation and convection heat transfer from the warm roofs. Temperature variables are used in Fanger's equations to calculate the comfort status of a given location.
- Predicted Mean Vote (PMV) and Predicted Percentage of Dissatisfied (PPD) plots and linear probes. PMV and PPD plots directly indicate levels of comfort in places inside buildings based on Fanger's equations.

2.8 Scenarios

Different scenarios are used to construct systematic models of the environment inside and outside Javanese buildings. This makes sure that the building aerodynamic and thermal performance is only evaluated under the same environment characteristics and occupants' requirements as the original condition of the Javanese buildings. It is intended that these scenarios avoid biased interpretations. Data to generate the scenarios are based on:

- for occupants' behaviours: study of literature and interviews with experts.

- for climate characteristics: statistical interpretation of climatic data.
- for the simplified model of Javanese building: study of literature, interviews with experts, and field measurements.

2.9 Summary

- This research consists of three main sections: the case study (Javanese buildings), the tool (a CFD program), and the experiments (of thermal comfort performance). The experiments act as the processes in which the tool is systematically used to explain the case study.
- All three sections contain problems, potentially leading to biased results. Careful and detailed study of those problems should eliminate any bias.
- This research is a linear process consisting of a general procedure (the main procedure) and sub-procedures. The procedure has been designed to cut a clear research path from the very beginning to the end goals.
- By preparing, in detail, the steps of every experiment, problems could be anticipated and localised. Any deviation could be detected and the research redirected to the original path.

The following chapter (Chapter Three) discusses the Yogyakarta Special Region, where Javanese buildings evolved.

Endnotes

¹ Data from Texas Technology Experimental building, Texas Tech University, Lubbock, Texas.

² Selvam, R.P., Computation of Pressure on Texas Tech Building, Journal of Wind Engineering and Industrial Aerodynamics, 41-44 (1992), pp. 1619-1627.

³ A wind tunnel at the Opus International Consultants' Laboratory, Lower Hutt, New Zealand.

⁴ Williams, P.T., Baker, A.J., Kelso, R.M., 1996, Numerical Calculation of Room Air Motion - Part 2: The Continuity Constraint Finite Element Method for Three-Dimensional Incompressible Thermal Flows, in ASHRAE Transactions, vol.100, part 1.

⁵ Ibid.

⁶ Discussion through the internet.

⁷ Selvam, loc.cit., pp. 1619-1627

⁸ Shao, L., Sharples, S., Ward, I.C., Building Pressure Coefficient: Application of Three-dimensional CFD Methods to Prediction, Building Service Engineering Research Technology, vol.13 (1992), no.2, pp.107-111.

Handwritten text in a cursive script, likely Burmese, covering the left page of the document. The text is arranged in approximately 20 horizontal lines, with some characters appearing to be stylized or decorative. The script is dense and fills most of the page area.



3. YOGYAKARTA SPECIAL REGION

3.1 Introduction

The environmental performance of a building is closely related to its physical and cultural settings. Javanese architecture evolved within the environment of the Yogyakarta Special Region. Thus, an understanding of the environmental characteristics of this region is important in discussing the thermal performance of Javanese architecture.

This chapter describes the physical and cultural features of Yogyakarta Special Region, and of the locations where Javanese architecture was studied. A brief description of the environments where Javanese architecture developed is also given. From that description, it continues into a detailed discussion of the region's climatic conditions. General explanation of the population, housing and culture of Yogyakarta Special Region are supplied, briefly illustrating life in Yogyakarta.

The sub-chapter discussing climate (sub-chapter 3.4) uses data from the Meteorology and Geophysics Office.¹ The weather station is situated at Adisucipto airport, at 7°47' south latitude and 110°26' east longitude, and 106.75m above sea level. Data was compiled from January 1981 to December 1994. This data is then combined with field measurements, conducted from 15 October 1996 to 13 January 1997, and interpreted accordingly. Field measurements were conducted at the ten sites where Javanese building were being observed.

Selection of the ten buildings to be studied was based on accessibility, condition of the buildings, and a trade-off with the limited time available.

3.2 Region

The Yogyakarta Special Region is the second smallest province in Indonesia, after Jakarta. (See Figure 3-1) It is only 0.17% of the total area of Indonesia and consists of Yogyakarta Municipality (or simply called Yogyakarta) and four surrounding regencies: Sleman, Bantul, Kulon Progo, and Gunung Kidul. It was declared a special region after Indonesian independence, under an agreement between the new government of the Republic of Indonesia and the Yogyakarta Sultanate.

The Yogyakarta Special Region is in Java, and bounded by a triangle with Mount Merapi (2911 m above sea level, and one of the most active volcanoes in the world) at its apex, and the Indian Ocean beaches as its base (Figure 3-2). The Yogyakarta Special Region is bordered by Wonogiri Regency in the southeast, Klaten Regency in the northeast, Magelang Regency in the northeast, Purworejo Regency in the southwest, and the Indian Ocean in the south

Yogyakarta Special Region is 3,185.80 km² in area and spans between 7°33' and 8°15' south latitude and between 110°0' and 110°50' east longitude. It consists of:

- Yogyakarta municipality (32.50 km², 14 districts)
- Sleman regency (574.82 km², 17 districts)
- Bantul regency (506.85 km², 17 districts)
- Gunung Kidul regency (1,485.36 km², 15 districts)
- Kulon Progo regency (586.28 km², 12 districts)

3.3 Urban, Suburban and Rural

The capital of Yogyakarta Special Region is Yogyakarta Municipality, centrally situated in the region. This city is growing as a centre of modern private businesses and governmental activities. However, like other rapidly developing cities in Indonesia, Yogyakarta is characterised by many *kampongs* (city villages, high-density residential areas within the city) with relatively poor building conditions (constructionally, environmentally and aesthetically). The juxtaposition of new modern buildings and poor buildings creates an ironic architectural landscape in Yogyakarta.

As demand for housing increases, developers build housing estates out of the city. These new resettlements have broadened the distribution of the city's activities and encouraged the development of suburban areas. In contrast, rural areas are growing slowly.

Typically, the Indonesian urban scene mixes poor buildings with new ones. The average rural dwelling is untouched by modern development. The Javanese architectural orders can still be seen in many of them. However, most are in varying stages of dilapidation, as owners often cannot afford the high maintenance costs.

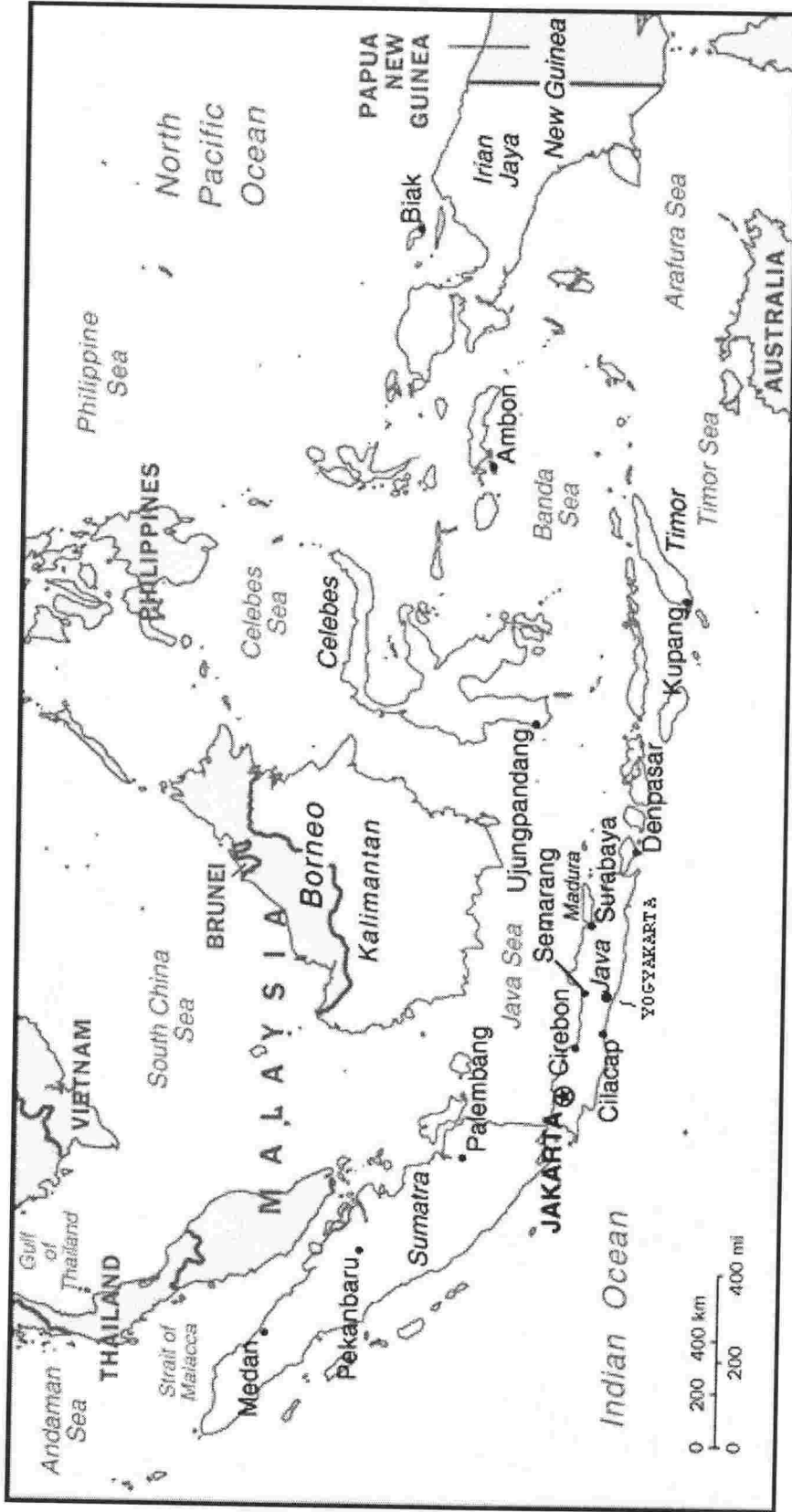

Figure 3-1 Indonesian archipelago.²

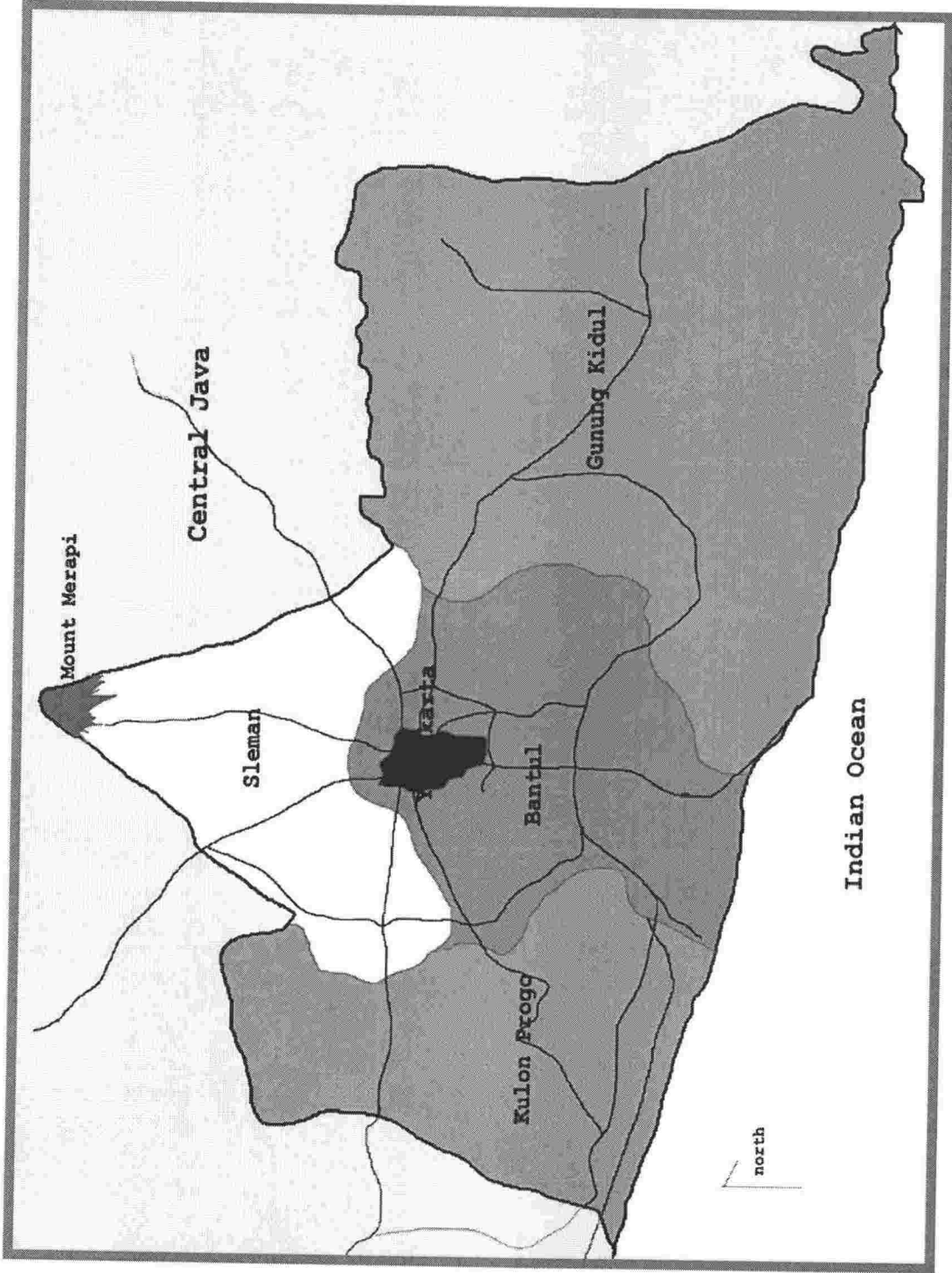

Figure 3-2 Yogyakarta Special Region. Javanese like drawing an imaginative line from Mount Merapi, Sultan Palace and Indian Ocean to form to create a sacred axis.

3.4 Topography

Most of the land in Yogyakarta Special Region is fertile due to Mount Merapi, abundant rains, and rivers. Rice fields dominate the landscape in both suburban and rural areas. The northern part of the region is dominated by its highest point, Mount Merapi. This volcano and its surrounding hills form the higher land of the Yogyakarta Special Region. Mount Merapi is considered a dangerous volcano, having



Figure 3-3 The Yogyakarta downtown with colonial buildings, heritage of Dutch colonialism.

claimed lives by its hot clouds and cold lahars. However, it stimulates greenery and water springs. The eastern part of the region consists of hilly lands forming a long hill that ends as a cliff coast at the Indian Ocean. Formed by gypsum hills, it is dry (very few water resources) and lacks plants. The western part of the region is hilly. Hills extend from northwest to the south and form an alluvial coastal plain. The middle part of the region is a narrow valley; Yogyakarta is located in this area.

The Javanese buildings being studied in this research are situated within Yogyakarta and Sleman regency. Yogyakarta has an average altitude of 144 m above sea level. With its relatively high altitude and the flows of three rivers through the city (Winongo, Code, and Gajah Wong) Yogyakarta is never flooded. Sleman regency has altitudes from 130 m to 1,200 m above sea level. The region has no swamps.

3.5 Climate

While the climate of Yogyakarta Special Region is generally warm and humid, it can vary from place to place. This sub-section discusses wind direction and velocities, rain and humidity, air temperatures, and solar radiation.

3.5.1 Wind Directions and Velocities

According to global yearly air movement, the main wind direction for the southern hemisphere should be from northwest to southeast during the rainy season (between April and September), and southeast to northwest during the dry season. However, data from the Meteorology Office show only three dominant wind directions: 240°, 210°, and 180°. The data, described in Figure 3-4, does not describe a pattern of wind following an alternating linear cycle from the northwest to the southeast. Rather, it mostly moves from the southwest to the northeast. This is contrary to the common belief that wind flows in alternately changing directions on a southeast to northwest axis. Data shows that wind flows in

almost the same direction all year. The 240° wind is the most frequent monthly wind direction, occurring 34 of 84 months (This being the number of months from January 1981 to December 1987). The most frequent monthly average wind speed, 7 knots (12.97 km/h or 3.6 m/s) occurs 21 of 84 months.

Wind speeds vary. In warm humid regions, calm hot days frequently contribute to thermal discomfort. During the monsoon the wind speed in these regions has reach a world record high of 108 km/h.³ However, data from Meteorology Office show that in Yogyakarta the wind speed average 6.86 knots (12.7 km/h or 3.53 m/s) with average high and low wind speeds of 10 knots (18.53 km/h or 5.15 m/s) and 3 knots (5.56 km/h or 1.55 m/s) respectively. In Yogyakarta, the windiest day ever recorded, 5 November 1986, wind only reached 28 knots (51.88 km/h or 14.42 m/s).

There is no obvious correlation between wind direction and its velocity. Figure 3-5 shows an apparent tendency for wind velocities to cycle annually. Despite the difficulty in precisely defining the cycle on a monthly basis, December, January and February appear to be the windiest months. During these months wind directions fall between 180 and 240 °.

For architectural design purposes, an average wind speed of 3.53 m/s is useful. However, it should be noted that the measurements which determined this figure were taken in an open area of Adisucipto Yogyakarta airport. Methods for adjusting this speed for urban and sub-urban areas can be found in many references such as those written by Aynsley⁴ and Koenigsberger.⁵ Atmospheric boundary layers for these areas are different. Methods used to draw atmospheric boundary layers can be found in Aynsley⁶ and Etheridge.⁷ Considering that Javanese architecture was developed long ago, when plants and rice fields dominated the environment, a boundary layer of open country with low scrub or scattered tress, area category 2, can justifiably be applied.

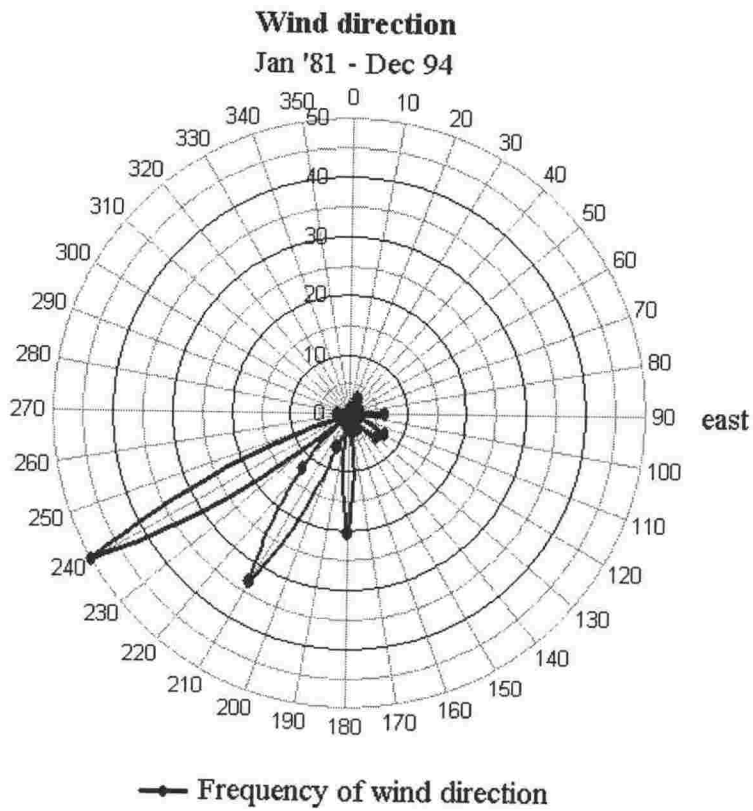
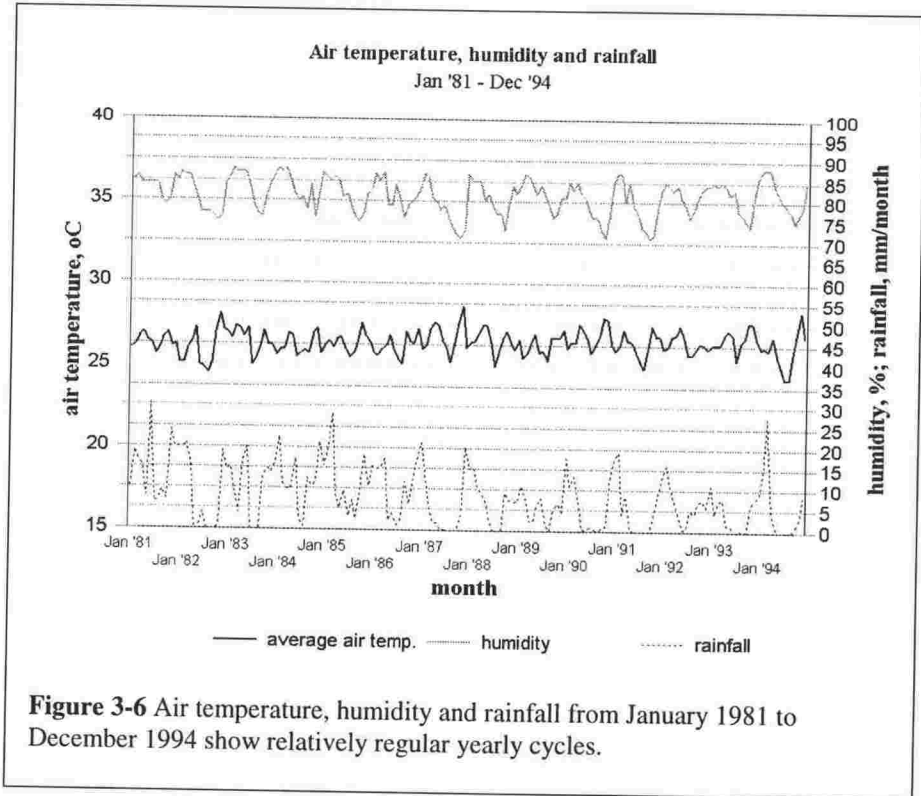
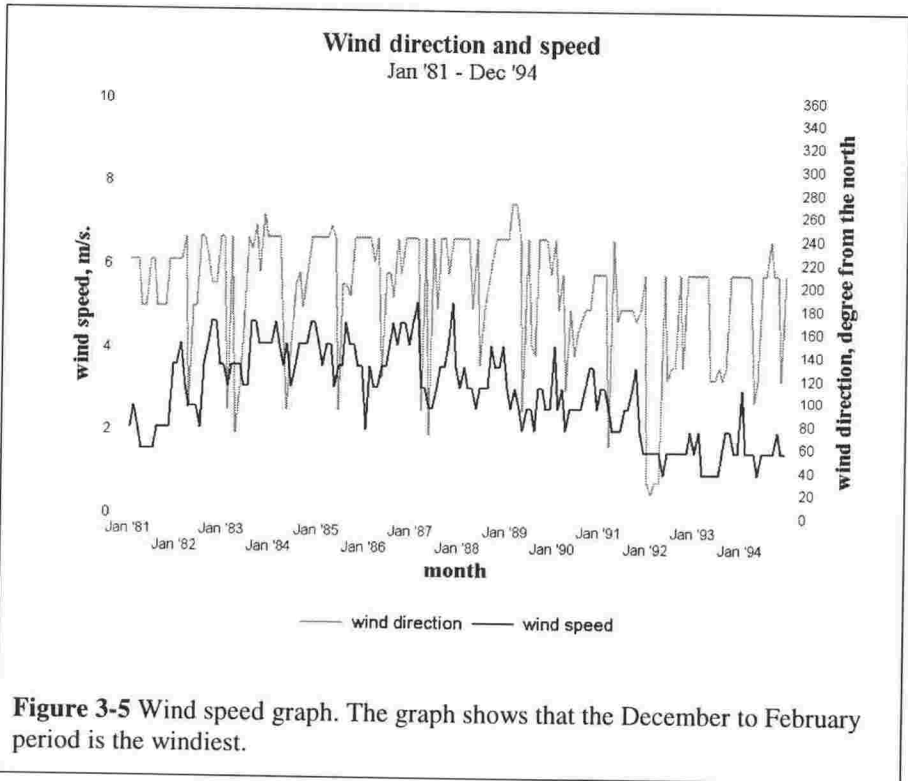
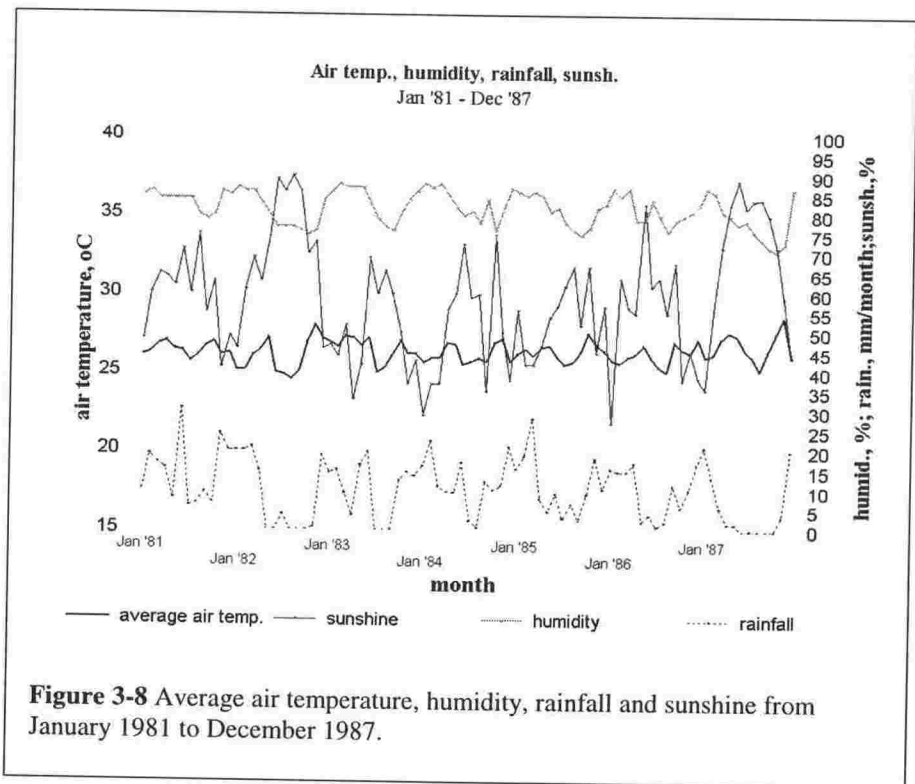
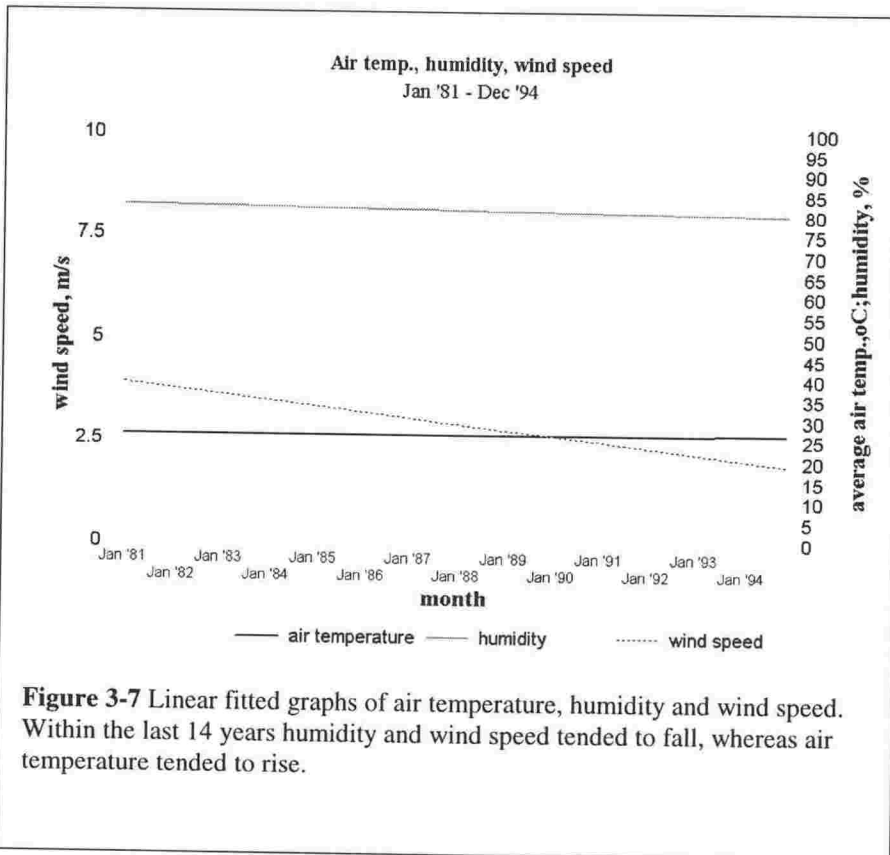

Figure 3-4 Wind directions and their frequencies from January 1981 to December 1994. The graph shows three dominant wind directions. No two dominant opposing directions occur.





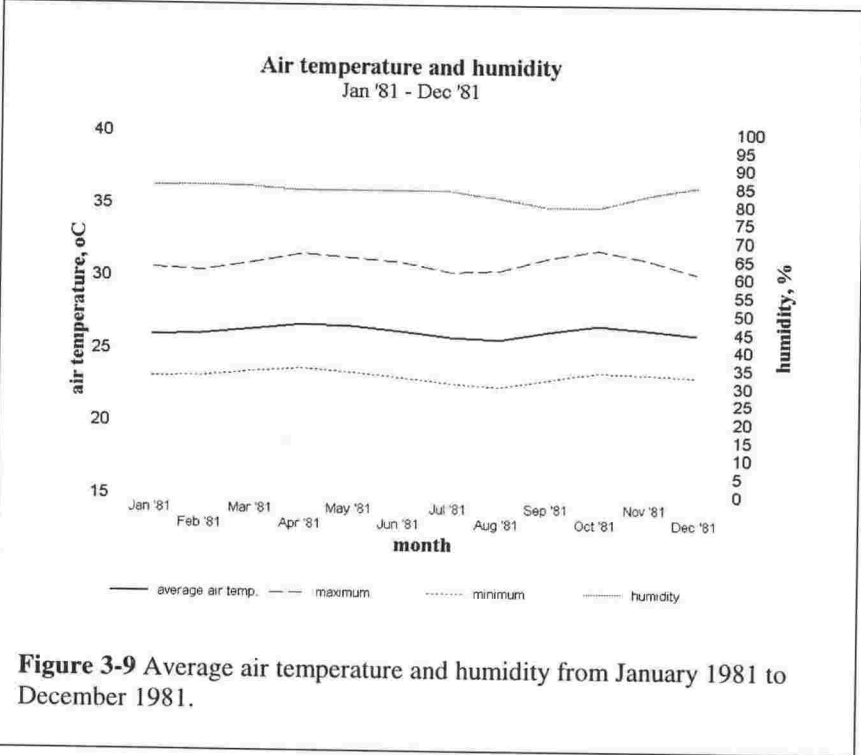

Figure 3-9 Average air temperature and humidity from January 1981 to December 1981.

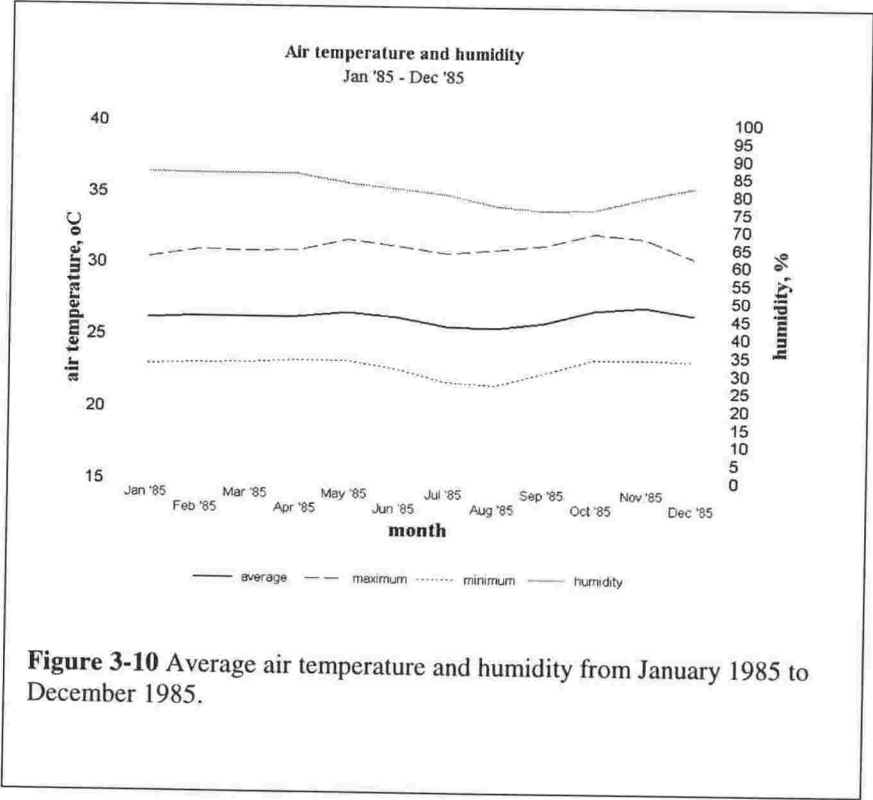
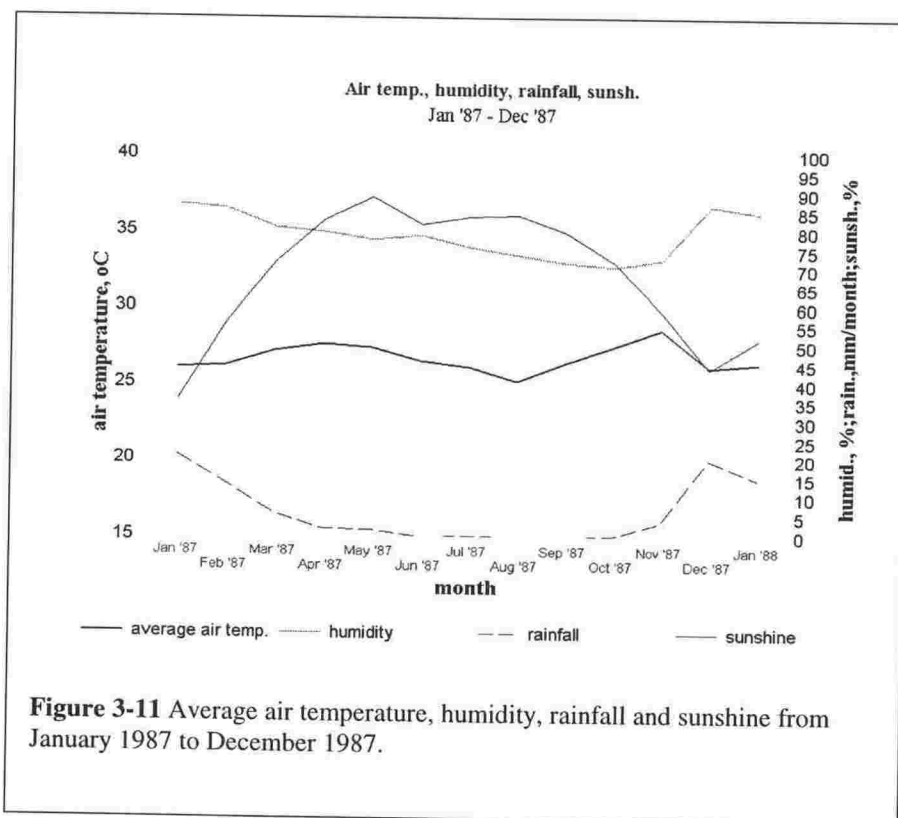

Figure 3-10 Average air temperature and humidity from January 1985 to December 1985.



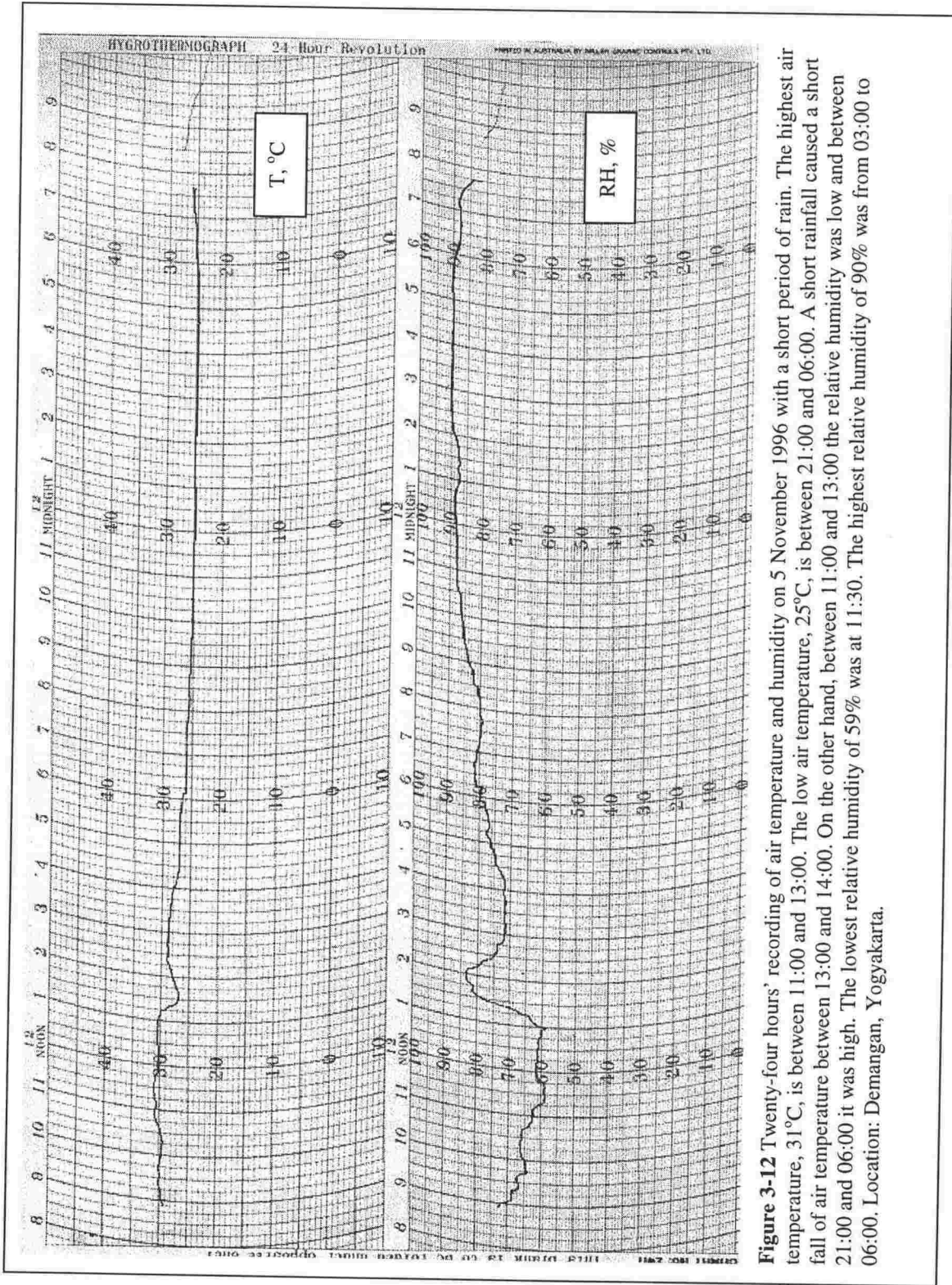

Figure 3-12 Twenty-four hours' recording of air temperature and humidity on 5 November 1996 with a short period of rain. The highest air temperature, 31°C, is between 11:00 and 13:00. The low air temperature, 25°C, is between 21:00 and 06:00. A short rainfall caused a short fall of air temperature between 13:00 and 14:00. On the other hand, between 11:00 and 13:00 the relative humidity was low and between 21:00 and 06:00 it was high. The lowest relative humidity of 31% was at 11:30. The highest relative humidity of 59% was from 03:00 to 06:00. Location: Demangan, Yogyakarta.

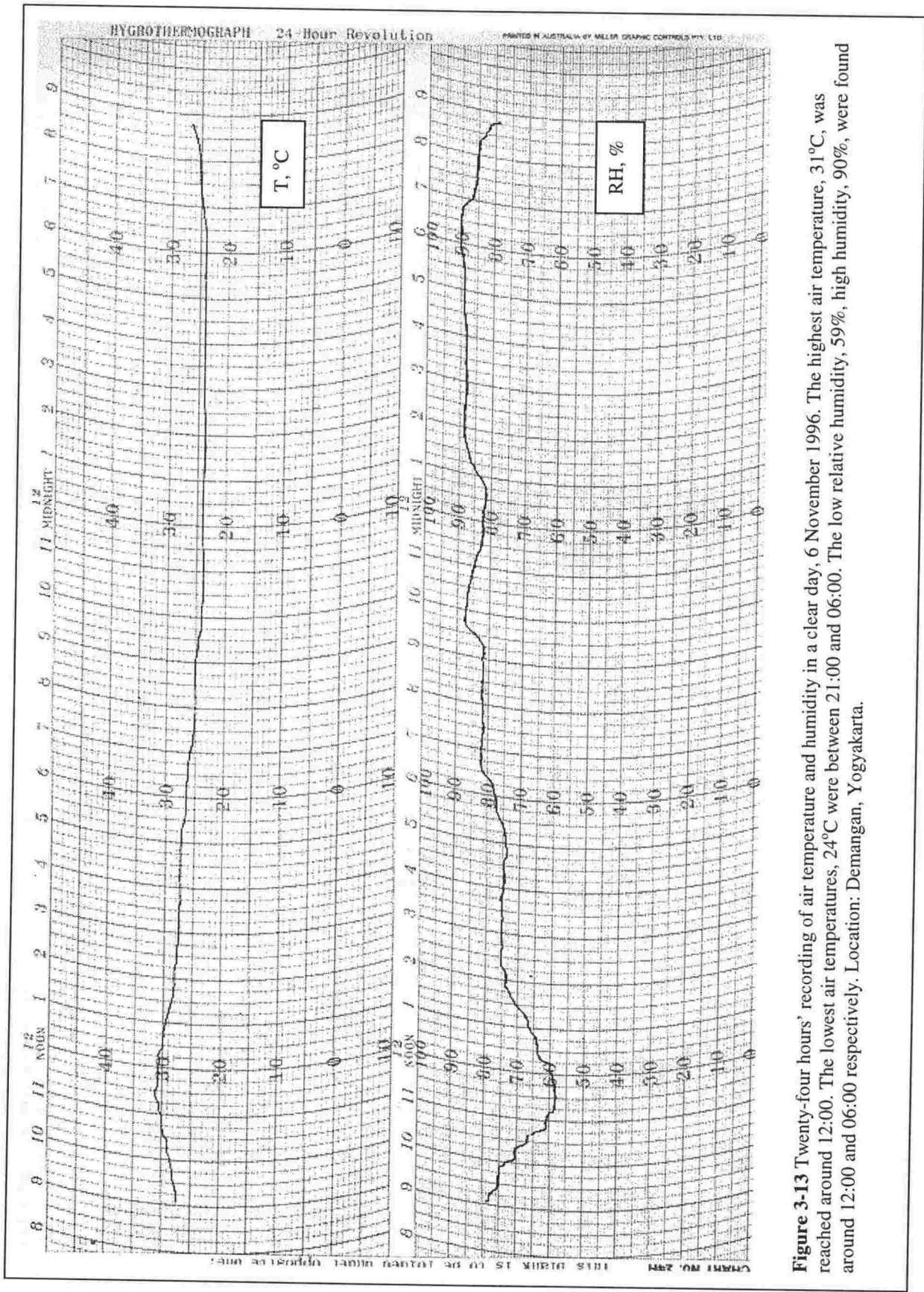

Figure 3-13 Twenty-four hours' recording of air temperature and humidity in a clear day, 6 November 1996. The highest air temperature, 31°C, was reached around 12:00. The lowest air temperatures, 24°C were between 21:00 and 06:00. The low relative humidity, 59%, high humidity, 90%, were found around 12:00 and 06:00 respectively. Location: Demangan, Yogyakarta.

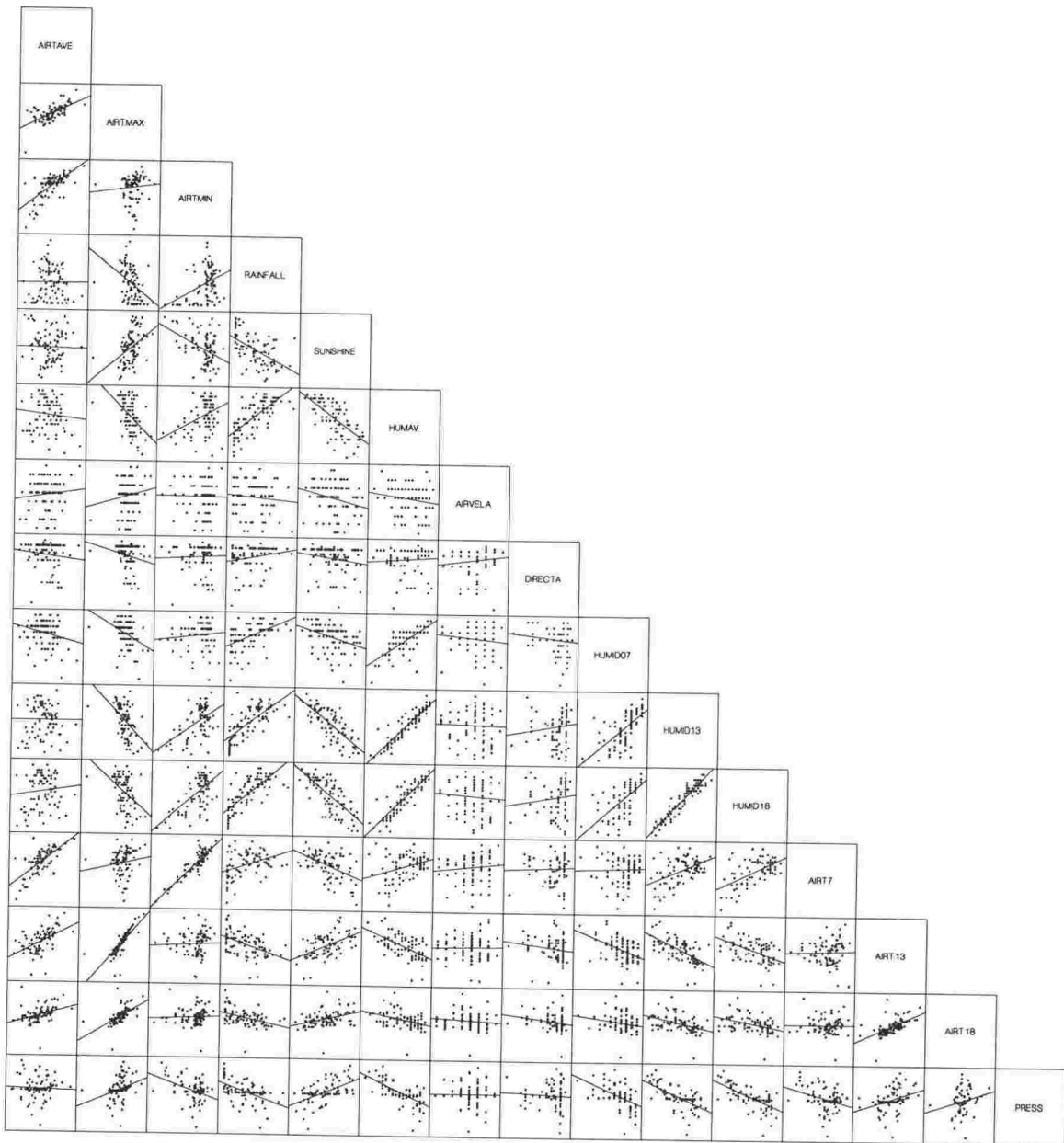

Figure 3-15 Correlations between climatic factors. An inclining line means both variables have the same increase and decrease direction. A declining line means both variables have opposite direction of increase and decrease. The steeper the line the stronger the correlation is. For example, it can be graphically seen that the sunshine has a strong correlation with maximum air temperature. Longer sunshine hours result in a higher maximum air temperature. But, more rainfall means lower maximum air temperature. (AIRTAVE = Average air temperature; AIRTMAX = maximum air temperature; AIRTMN = minimum air temperature; RAINFALL = rainfall; SUNSHINE = sunshine; HUMAV = average humidity; AIRVELA = average air velocity; DIRECTA = average wind direction; HUMID07 = humidity at 7 a.m.; HUMID13 = humidity at 1 p.m.; HUMID18 = humidity at 6 p.m.; AIRT7 = air temperature at 7 a.m.; AIRT13 = air temperature at 1 p.m.; AIRT18 = air temperature at 6 p.m.; PRESS = air pressure)

Considering that Javanese buildings traditionally face south (or north), identification of a single dominant wind direction of 240° is important. According to Kukreja, wind blowing

obliquely into openings can still be effective in encouraging indoor air movement.⁸ A recent study by Kindangen, Krauss, and Depecker on the effect of various types of roofs on the indoor wind velocity, found that incident wind of 30° still induced good indoor velocity although a wind direction normal to the openings creates the best indoor air movement.⁹

3.5.2 Rain and Humidity

Monthly average rainfalls are low. However, 60mm rainfall in a single day is not entirely uncommon. A linear fitting of the rainfall graph based on data collected by Biro Meteorologi - Dinas Navigasi Udara - Tentara Nasional Indonesia - Angkatan Udara (meteorology office within the Indonesian Air Force) from January 1981 to December 1994 shows that rainfall tends to decrease from 13 to 5 mm/month. Average monthly relative humidity is high.

Figure 3-6 shows that relative humidity starts declining around March and reaches the lowest point around October before rising again. Maximum and minimum average monthly relative humidity readings are 88% and 71% respectively. Figure 3-7 shows a linear fitting of the average humidity recorded from January 1981 to December 1994. It demonstrates that over 14 years, the average monthly relative humidity has decreased by 2.5%, from 82.5% to 80%.

Annual cycles are evidenced from Figure 3-9 to Figure 3-11. Although rainfall exists throughout the year, as it tends to warm-humid climatic regions, it generally has a specific pattern. March appears to be the wettest month, whereas August is the driest month. The average monthly maximum and minimum were 25 and 0 mm/month. There is a significant correlation between relative humidity and rainfall. (See Figure 3-15.) Higher rainfalls relate to higher relative humidity. According to data from Meteorology Office relative humidity of 99% was found on 1 December 1981 at 07:00. The relative humidity of 24% was found on 12 October 1991 at 13:00.

Evidence of a daily cycle of relative humidity in Yogyakarta can be seen in Figure 3-12 and Figure 3-13. These graphs were taken from Demangan, Yogyakarta. Early morning usually has the most humid air whereas around noon is usually the least humid. In the afternoon the humidity rises again. In both figures, the difference between high and low relative humidity within 24 hours was 31%.

3.5.3 Air Temperatures

The air temperature in Yogyakarta Special Region varies between 20°C and 34°C, depending on the location. In general, the average air temperature becomes lower as one moves from south to

north. The coolest air temperatures can be found around Kaliurang and Pakem (18° to 26° C). In Yogyakarta, the air temperature falls between 27° C and 34° C. In Yogyakarta, extreme maximum and minimum air temperatures were measured at 37.4° C on 7 November 1993 and 16.1° C on 20 August 1982, respectively.

Data from January 1981 to December 1994 shows a small increase (0.5° C) in air temperature. The average monthly maximum, monthly average and average monthly minimum air temperature rise, respectively, from 31 to 31.5° C, from 26 to 27.5° C and from 23 to 23.5° C.

Three illustrations of the yearly cycle of air temperatures can be seen from Figure 3-9, Figure 3-10 and Figure 3-11. The air temperatures start declining in May, reach their lowest point in August, incline to their peak around November, drop toward December and up again toward May. This phenomenon can be readily attributed to the position of the sun relative to the Yogyakarta latitude. However, the change in air temperature occurs about one month after the change of the sun position.

3.5.4 Solar Radiation

There is no evidence that the intensity of solar radiation has been recorded systematically and continuously in the Yogyakarta Special Region. The Meteorology Office does not include solar radiation in its climatic record system; only the daily percentage of sunshine hours is recorded. Even this chronicle has been abandoned since September 1988. Neither does the Statistics Office record the intensity of solar radiation in Yogyakarta. However, some public and private institutions with an interest in the field have conducted limited recordings.

Situated within the warm-humid equatorial region, Yogyakarta Special Region is frequently cloudy. The clouds reduce the high intensity of solar radiation. However, although reducing solar intensity, clouds encourage a green house effect, meaning the air will not necessarily be cooled. Figure 3-8 shows that the monthly average of sunshine hours varies between 27 and 90%.¹⁰ It can also be graphically determined that the sunshine hours plot relates inversely to the rainfall plot. Higher rainfall corresponds to lower sunshine hours, as the sun is shielded by cloud during rainy days.

Daytime for tropical regions is 12 hours +/- 30 minutes. This daytime length, combined with 60 to 90% cloud coverage, will determine the solar exposure values. The cloud factor is difficult to calculate, as cloud thickness changes continuously, and the filtering effect on the sun's rays varies accordingly.

The solar radiation intensity received by a horizontal plane at ground level changes over time. The Solar Constant (the intensity of solar radiation at the farthest limits of the atmosphere) is 1395 W/m^2 with a correction factor of 2% caused by the output fluctuations from the sun and 3.5% affected by distance changes between the sun and earth (another reference gives a figure of 1353 W/m^2 and correction factor of 1.5%).¹¹

The solar radiation intensity differs from place to place. In Mombasa (equatorial), Kenya, it ranges between 454 and 631 W/m^2 .¹² A research project conducted in Surabaya ($\sim 8^\circ$ S.L.), East Java, found the range to be between 447 and 677 W/m^2 .¹³ In Bangui ($\sim 5^\circ$ N.L.), Central Africa Republic, it ranges from 442 to 606 W/m^2 .¹⁴ Research conducted in Jakarta, Bandung and Yogyakarta¹⁵ (all between 5 and 8° S.L.) found the average radiation to be 45% of the solar constant ($\sim 627.75 \text{ W/m}^2$). In Malaysia (2 - 10° N.L.) and the Philippines (5 - 20° N.L.), respectively, the ranges are 45-60% (627.75 - 837 W/m^2) and 29-48% (404.55 - 669.6 W/m^2).¹⁶ Rao gives a figure of 1000 W/m^2 in clear midday and 360 - 500 W/m^2 when cloudy (diffuse).¹⁷ Given these ranges, an average intensity of 540 W/m^2 seems reasonable to use as an approximation. As a rule of thumb, the peak air temperature caused by solar radiation is around one to two hours after midday, and the minimum is around one to two hours before sunrise.

Another approach to estimating ground surface solar radiation is given in Figure 3-16. A plane on the ground will receive diffuse (23%) and direct (27%) radiation. At ground level total intensity is thus 50%. For a solar constant of 1395 W/m^2 , the total solar intensity received by the plane will be 697.5 W/m^2 . Even though this figure is not impossible to reach (for some areas, a radiation intensity over 700 W/m^2 is common) using the

lower average figure (540 W/m^2) seems more realistic in light of those measurements which have been done in Indonesia and in countries of similar latitude. In terms of solar energy, it will avoid an overestimated calculation.

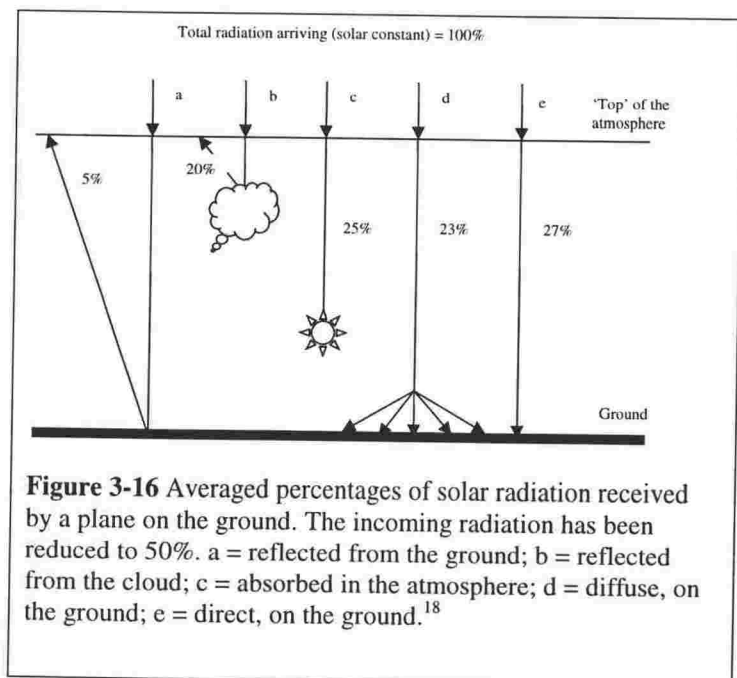

Sudirman conducted a short recording of solar radiation in Yogyakarta.¹⁹ Using a pyranometer he measured global solar radiation intensity for 24 hours each day between 16 February and 22 February 1990. Global solar radiation intensity combines direct and indirect intensities. He found that despite the intermittent presence of clouds, the weekly average intensity still reached 422.1W/m². Measurement between 10:30 and 13:30 found the minimum and maximum intensities were 373.24W/m² and 487.38W/m² respectively.

3.6 Population

The population of Yogyakarta Special Region reached 3,185,384 by mid 1996, according to Kantor Statistik (Statistics Office). They were distributed among five regions. Table 3-1 shows Yogyakarta itself the most populated area.

Table 3-1 Population and density in Yogyakarta Special Region.²⁰

Areas	Population (persons)(%)	Density (persons per square kilometre)
Yogyakarta (municipality)	471,335 (14.8)	14,502.61
Sleman	804,336 (25.3)	1,399.34
Kulon Progo	431,511 (13.5)	736.1
Bantul	748,517 (23.5)	1,476.8
Gunung Kidul	729,655 (22.9)	491.23

3.7 Housing

The general condition of housing can be seen in Table 3-2. It should be observed that this table does not consider the quality of the house vis-à-vis standard buildings codes. Timber buildings, for example, sometimes relate to poverty because people relate those buildings to non-permanent dwellings. It is popularly held that a permanent building should be made from brick.

The most popular materials for an ordinary permanent building are clay tiles, brick and cement which are used for roofs, walls and floors respectively (see Table 3-2). Alternative roofing materials are corrugated steel and asbestos. They are less expensive materials, although they are less attractive in appearance. For walls, bamboo is the second most frequently used material. Floors are usually made from a simple cement layer on top of brick base or cement tiles. A considerable number of dwellings still have bare soil for floors; these tend to be found in the villages.

Table 3-2 Housing condition in Yogyakarta Special Region (as at mid-1996)²¹

Roof	Concrete	1,258 (0.16%)
	Timber	2,904 (0.38%)
	Corrugated steel, asbestos	10,409 (1.36%)
	Clay tiles	750,289 (98.08%)
	Other	116 (0.02%)
Wall	Brick	562,627 (73.55%)
	Timber	61,537 (8.04%)
	Bamboo	140,116 (18.32%)
	Other	696 (0.09%)
Floor	Marble, ceramics	39,087 (5.11%)
	Cement tiles, terrazzo	206,127 (26.95%)
	Cement, red brick	302,332 (39.52%)
	Timber, bamboo	313 (0.05%)
	Bare soil	182,826 (23.9%)
	Other	34,301 (4.48%)

3.8 Culture

The main indigenous culture of Yogyakarta Special Region is Javanese. Javanese culture was centralised at Yogyakarta Palace with a Sultan as ruler; formerly agrarians, the Javanese demonstrated loyalty to the Sultan's family.

Since its independence, the Republic of Indonesia has been governed by a president. Sultans have assumed a social and cultural status.²² In Yogyakarta, the Sultan still has many followers. They obey all the Sultan says and practise almost all of old ritual ceremonies such, as giving offerings to the queen of the Indian Ocean (*Nyai Roro Kidul*), the rice goddess (*Dewi Sri*), and the guard spirits of Mount Merapi.

Religiously, Muslims form the majority (88%), but there are also Christians (10%), Buddhists and Hindus (the last two faiths share the remaining 2%). Some Javanese practice traditional beliefs developed by mixing local belief with Islam. This belief is called *Kejawen*

(Javanism) and is followed by many Javanese regardless of their educational, economic or social status. *Kejawen* is not a religious category, but signifies a style of life inspired by Javanese thinking.²³

A large family is favoured in Javanese culture. Having many children gives a sense of pride, every one drawing good fortune. It was not uncommon for a family to have more than five children. Tradition intends that children take care of their parents. It is a kind of future assurance.²⁴ Unfortunately, this preference has diminished somewhat since the government actively introduced its family planning programme, encouraging new families to limit the number of their children to two.

Javanese culture has influenced Javanese architectural orders. Many references (such as those written by Prijotomo²⁵, Dakung²⁶, and Hamzuri²⁷) have discussed the complicated orders of Javanese architecture. They describe the effects of traditional buildings' design on their occupants' prosperity.

Contemporary, life in Yogyakarta is a mixture of cultures as many visitors from other parts of Indonesia come to Yogyakarta as students, government employees, merchants, etc. (Yogyakarta is famous as the city of culture, the city of students and is the second largest tourist destination after Bali.) In general, though, Javanese culture still exerts a strong influence on daily life.

Understanding the cultural environment of Javanese people, including their activities and clothing, is useful in reconstructing the life condition within Javanese buildings. As Javanese were basically agrarians, they spent much time outdoors. Indoor activities were often limited to sleeping, praying, and other light work. Dr. Arya Ronald observes that within Javanese culture, residential buildings were mainly used by women, in which to give birth and raise children.²⁸ Thus, traditionally indoor activities related closely to female activities, such as preparing offerings, preparing for meal times, taking care of children, and knitting. Dr. Ronald also notes that while the father was the master of the family, the mother was the manager. Boys were trained to live outside from the age of ten. Girls stayed inside until their first menstruation.

Javanese clothing varies. Each type has its own philosophy and purposes. Most clothing had particular uses and related to the wearer's status. For ordinary people (or peasants), the clothing might consist of pants, a T-shirt (or bare breast), bare feet and a large hat made from coconut leaves; alternatively, it might be a sarong, shirt, and sandals.

3.9 Summary

- Javanese culture is dominant in Yogyakarta Special Region. Mount Merapi, the Sultan's Palace and the Indonesian Ocean (also called Indian Ocean) have important meanings for traditional Javanese culture. This culture is full of mysticism, which is reflected in its architecture.
- The relationship between Javanese building orientation and the dominant wind direction from the southwest (240° clockwise from the north) can be interpreted in two ways. It could be an unintentional benefit of Javanese buildings being south oriented; or second, it might indicate an awareness the Javanese builders had of building aerodynamics.
- The monthly average wind speed is 3.53 m/s.
- The slightly inclined landmass (Mount Merapi at the north and Indian Ocean at the south) and the occurrence of three rivers have made the land free from swamps and floods. Moreover, despite the regular occurrence of torrential rains, monthly average rainfall is surprisingly low, 5mm/month.
- Monthly average humidity is 80%.
- Monthly average temperature is 27°C. However, since the region is slightly inclined, the higher points at the north have cooler air while the lower lands to the south tend to be warmer. Data on monthly average solar radiation intensity is not available, but a figure of 540 W/m² is considered a reasonable design guide.
- The population is not evenly distributed. Yogyakarta Municipality has the highest density, of 14,502.61 person/km². This might encourage the construction of new buildings (to fulfil the fast growing housing demands) on formerly less dense lands.
- Clay tiles are the most popular materials for roofs (73.55%).
- Culture influences Javanese activities and clothing, which are parameters of thermal comfort. Javanese indoor activities are mostly sedentary, including sleeping, praying, and other light works. Clothing is made from light materials, loosely, and leaves large parts of the body exposed.

The following chapter (Chapter Four) discusses aspects of the architecture of Yogyakarta Special Region that makes Javanese buildings unique.

Endnotes

¹ Biro Meteorologi - Dinas Navigasi Udara - Tentara Nasional Indonesia - Angkatan Udara (meteorology office within the Indonesian Air Force).

² <http://www.emulateme.com/indonemap.htm>

-
- ³ Koenigsberger, O., Ingersol, T.G., Mayhew, A., and Szokolay, S.V., 1973, Manual of Tropical Housing and Buildings, Part 1: Climatic Design, Bombay: Orient Longman, p.26.
- ⁴ Aynsley, R.M., Melbourne, W. and Vickery, B.J., 1977, Architectural Aerodynamics, London: Applied Science Publisher, Ltd.
- ⁵ Koenigsberger, loc.cit., p.26.
- ⁶ Aynsley, op.cit., p.89.
- ⁷ Etheridge, D., Sandberg, M., 1996, Building Ventilation: Theory and Measurement, Chichester: John Wiley and Sons, p.20.
- ⁸ Kukreja, C.P., 1978, Tropical Architecture, New Delhi: Tata McGraw-Hill Publishing Company Limited.
- ⁹ Kindangen, J., Krauss, G., and Depecker, P., Effects of Roof Shapes on Wind-Induced Air Motion Inside Buildings, Building and Environment, Vol.32 (1997), No.1, pp.1-11.
- ¹⁰ Lippsmeier G., 1980, Building in the Tropics. Munchen: Callwey Verlag, p.37.
- ¹¹ Lunde P.J., 1980, Solar Thermal Engineering, Space Heating and Hot Water Systems, New York: John Willey & Sons, pp.62-9.
- ¹² Koenigsberger, op.cit., p.24.
- ¹³ Santoso M., 1989, Model Tata Ruang dan Rancangan Bangunan Hemat Enerji, Seminar Peran Perpindahan Panas dan Massa dalam Rancang Bangun Alat-alat Industri Kimia, Industri Mesin, dan Gedung Hemat Energi P.A.U. Ilmu Teknik Universitas Gajah Mada, Yogyakarta 18-19 Desember 1989, p.B.12.3.
- ¹⁴ Holm D., 1983, Energy Conservation in Hot Climates. London: Architectural Press, p.8.
- ¹⁵ Rao K.R., 1980, Solar Radiation, Measurement and Availability in the Countries of South East Asian Region in Lim B.B.P., SOLAR ENERGY APPLICATION IN THE TROPICS. Holland: D. Reidel Publishing Company, p.28.
- ¹⁶ Ibid.
- ¹⁷ Ibid.
- ¹⁸ Koenigsberger, op.cit., p.7.
- ¹⁹ Sudirman, R., Chotimah, ~1990, Pengukuran Tenaga Radiasi Surya di UGM, unpublished research report of Department of Physics, Gajah Mada University.
- ²⁰ Kantor Statistik Daerah Istimewa Yogyakarta.
- ²¹ This data was sent directly by Kantor Statistik Daerah Istimewa Yogyakarta with an e-mail on Saturday, 22 February 1997.
- ²² Sultan IX was formerly the Governor of Yogyakarta Special Region and the Vice President of the Republic of Indonesia.
- ²³ Mulder, N., 1978, Mysticism and Everyday Life in Contemporary Java: Cultural Persistence and Change, Singapore: Singapore University Press.

²⁴ Emiliana, Salamun, Taryati, Isyanti, 1992, Kesadaran Budaya tentang Ruang pada Masyarakat di Daerah Istimewa Yogyakarta (Studi Banding mengenai Proses Adaptasi), Departemen Pendidikan dan Kebudayaan, p.50.

²⁵ Prijotomo, J., 1995, Petungan: Sistem Ukuran dalam Arsitektur Jawa, Yogyakarta: Gadjah Mada University Press.

²⁶ Dakung, S., 1981, Arsitektur Tradisional Daerah Istimewa Yogyakarta, Yogyakarta: Dep. Pendidikan dan Kebudayaan.

²⁷ Hamzuri, 1982, Rumah Tradisional Jawa, Jakarta: Dep. Pendidikan dan Kebudayaan.

²⁸ This statement was discovered during some discussions with Dr. Arya Ronald, an architect and also expert in Javanese culture and architecture.

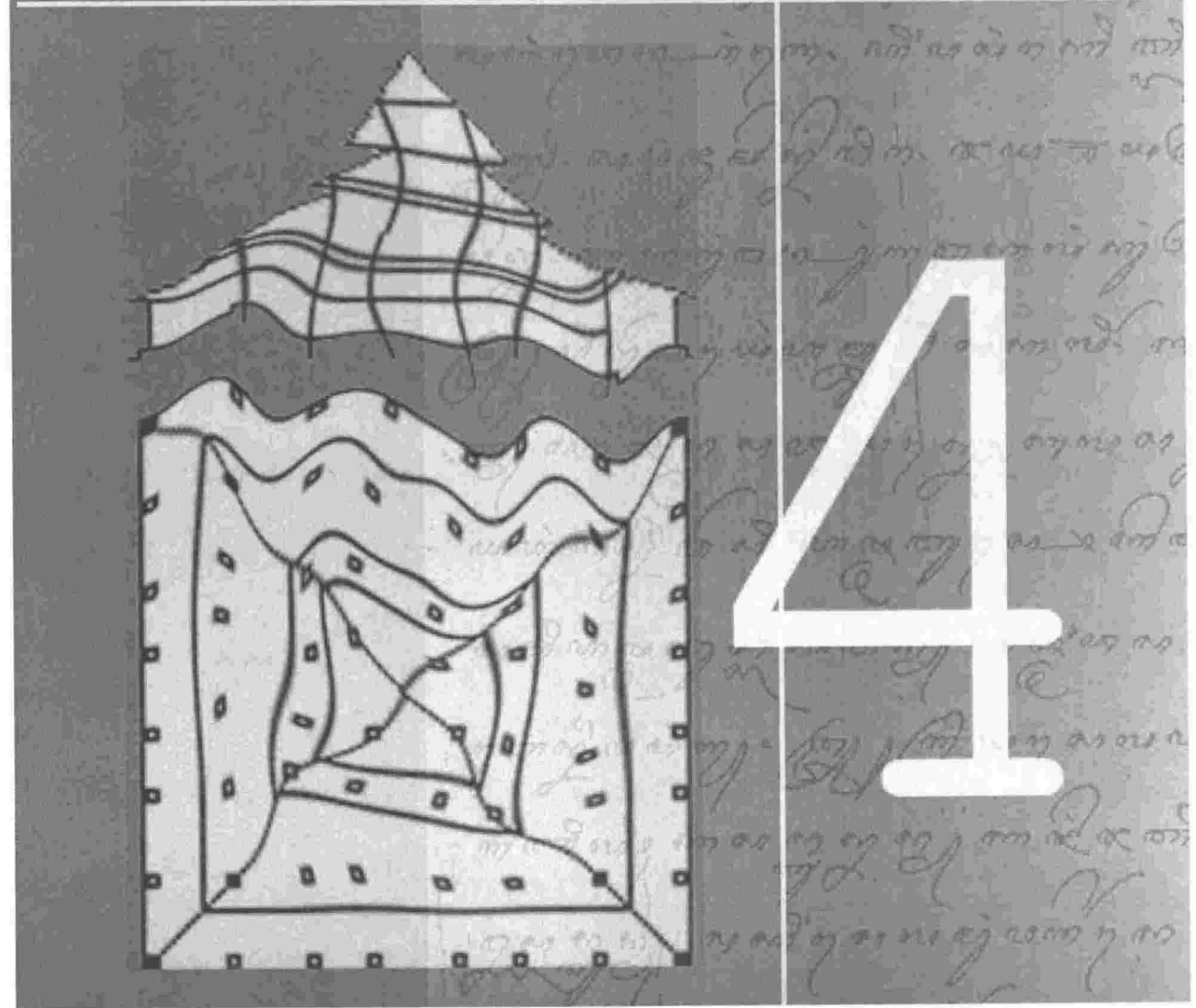

4. JAVANESE ARCHITECTURE

4.1 Introduction

This chapter discusses Javanese architecture in general (defined as the architecture style developed in the Yogyakarta Special Region) and the traditional orders which influence its designs. Beginning with a general review of Javanese architecture, the discussion then describes the styles of Javanese architecture and *petungan*. Traditionally, *petungan* (Javanese numerology) is a highly significant aspect of Javanese life. It exerts a very strong spiritual influence on architectural design.

4.2 Javanese Architecture in General

The grandeur of Javanese architecture developed from around the ninth century, as stone buildings were replaced by timber en masse. It was the reign of King Jayabaya, a highly respected ruler, whose palace was in Pamenang. One of his assistants, Adipati Santan, found wooden buildings superior to stone, being lighter in weight, more earthquake resistant, allowing wider spans, and being easier to construct and assemble. Formerly, buildings were made from stone and resembled *candhi* (temples).

As building became more complicated and required particular skills, the King established a group of people, called *Golongan Kalang* (*Kalang* group), who developed expertise in building construction. They were led by *Bupati Kalang*. The knowledge of these people, handed down through generations, was called *pengetahuan Kalang* (*Kalang* knowledge).

The methods employed by traditional Javanese architects are different from their western counterparts. The western concept of architecture does not fully account for Javanese architecture. In western terms, architecture primarily exists to provide for physical well being.¹ Any building construction is initiated by a design activity. Each building can be unique. Javanese architecture, on the other hand, accords physical aspects the lowest priority. The ceremony and philosophy behind and within construction are foremost. Variation between buildings is not extreme.

Javanese architecture is entrenched in the spiritual, a world fused with Javanese daily

life. From the very beginning to the end of every building construction, complicated considerations are made. The way and time to cut a tree to be used in the building, for example, should follow complicated rituals. The tree's spiritual currency is determined by its physical features (colour, branches, annual rings, etc.), the direction it falls in and environmental circumstances (eg. rain, barking dog, etc.) during its felling.

The beauty of Javanese architecture might reflect the high technological competency of its builders. However, experts like Wiryatmaja and Ronald argue that, technologically, Javanese architecture should not be viewed as particularly advanced. According to Wiryatmaja, *Kalang* knowledge does not share the scientific basis of modern architecture.² However, Javanese architecture is understood through a spiritual rather than a material approach (which might, for example, consider factors such as efficiency). Moreover, it will be very misleading to justify the quality of Javanese architecture without considering its physical and non-physical environment contexts. Wiryatmaja prescribes modernist scientific approach to *Kalang* knowledge, leading to a modern Javanese architecture.³

Javanese buildings apply two dimension systems, relative and standard.⁴ Relative length dimensions, named *pecak*, *kilan* (between 17 and 22cm)⁵, and *tebah*, are based on the owner's (or perhaps the builder's) body parts. *Pecak*, *kilan*, and *tebah* are, respectively, the length of the owner's feet, the span between the tip of the thumb and the tip of the small finger when they are outstretched, and the width of the hand. Standard dimensions are similar to the imperial system and use feet, inches (1/12 feet) and stripes (1/12 inches). Javanese also use *asta* (1 *asta* = 2 *pecaks*) and *depa* (See Figure 4-1). These standard dimensions have been used by *kraton* authorities (royal families) since 1806 and are considered a European influence.⁶

The adoption of anthropometric dimensions as base dimensions for architecture corresponds to modern architecture's human scale, giving primacy to the human body and its movements. Traditional architecture, though, directly adopts human scale relative to the owner's body and not to an abstracted ideal body. Modern architecture generalises human scale, formalising it within standards which are, in turn, expressed in an international system of measurement.⁷

4.3 Styles in Javanese Architecture

Literature by such researchers and authors on Javanese architecture as Ismunandar⁹, Hamzuri¹⁰, Dakung¹¹, Prijotomo¹² and Wiryatmaja¹³, have produced different classification systems, suggesting various styles through which Javanese architecture might be classified. Each system was based on roof forms. It is widely accepted that there are five main types of Javanese architecture: *Panggung Pe*, *Kampung*, *Limasan*, *Joglo*, and *Tajug*. Authors still debate on how these five main styles might be related. Hamzuri and Dakung wrote that *Panggung Pe* has the simplest basic form. They therefore suggest it should be

considered first type, followed by *Kampung*, *Limasan*, *Joglo*, and *Tajug* as the degree of complication increases. Conversely, Prijotomo and Wiryatmaja argue that *Panggung Pe* was not recognised in old literature. They found that concentric *Tajug* to be the first basic type, from which was derived *Joglo*, *Limasan* and *Kampung*. McLuhan supports their opinions, based on his observation that vernacular buildings, such as Eskimo igloos and Indian wigwam, are predominantly concentric.¹⁴ *Tajug* is concentric. The Department of Culture and Education of Indonesia, in its book *Sejarah Daerah Istimewa Yogyakarta* (The History of Yogyakarta Special Region) describes carvings found in Prambanan temple which show fifteenth century buildings made from timber, on the ground, or on stilts, with *Kampung* or *Limasan* like forms.¹⁵ Here there is a strong Indian influence. The carvings show no sign of the presence of *Joglo* and *Tajug*. Meanwhile, Prasodjo's study of temples scattered around Java suggested that between the ninth and the sixteenth centuries there were three dominant styles of building: *kampung*, *limasan*, and *tajug*.¹⁶

Dakung produced the most detailed classification. He divided each main style, *Panggung Pe*, *Kampung*, *Limasan*, *Joglo* and *Tajug* into seven, ten, sixteen, seven and seven sub-styles respectively. He thus gives a total of forty-seven types. Like other authors, he also based his classification on roof forms.

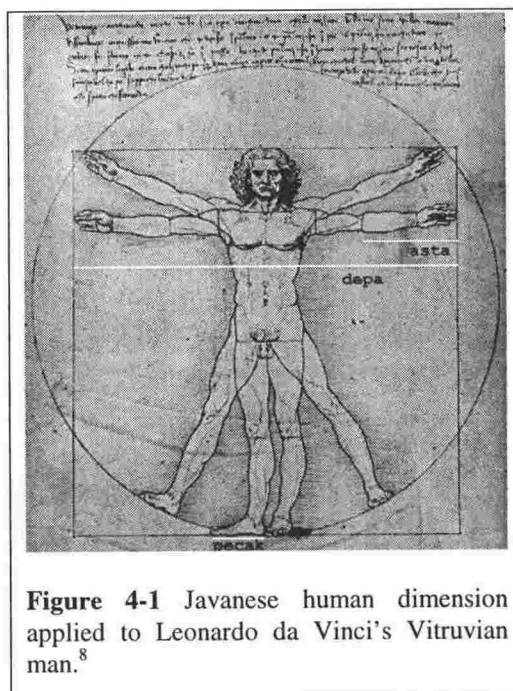
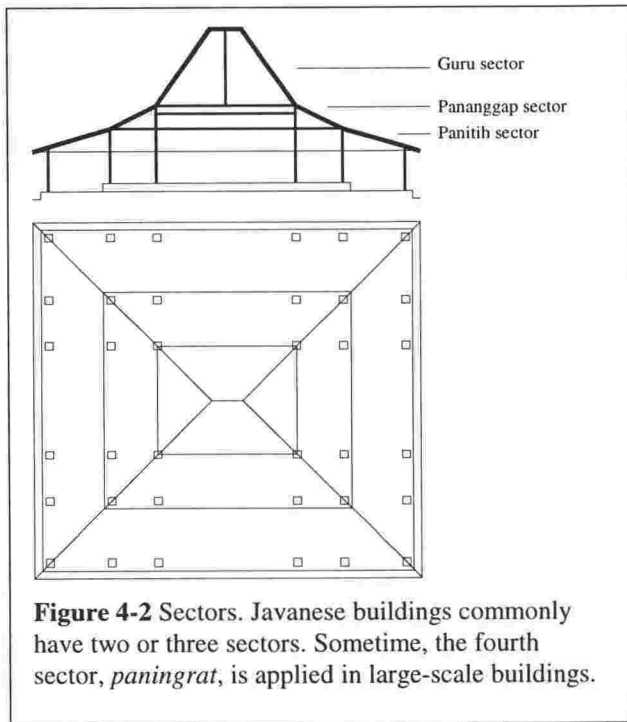

Figure 4-1 Javanese human dimension applied to Leonardo da Vinci's Vitruvian man.⁸



Despite arguments about how Javanese architecture styles should be listed, groups and variants within each group can be classified. Table 4-1 and Table 4-2 are derived mainly from Dakung's book and is combined with additional information found in the writing of Hamzuri, Ismunandar, Wiryatmaja and Prijotomo. Each style has been categorised according to its similarity of name and form.

Both tables show how each style could be linked to other. There is evidently a systematic relationship

between groups and within each group. There is no form completely alien to other forms. Locating each style in an appropriate cell in Table 4-2, the relative position of other styles becomes clear. The empty cells might reveal ways in which new styles could be developed. Conversely, there may have been styles occupying those cells which have since vanished.

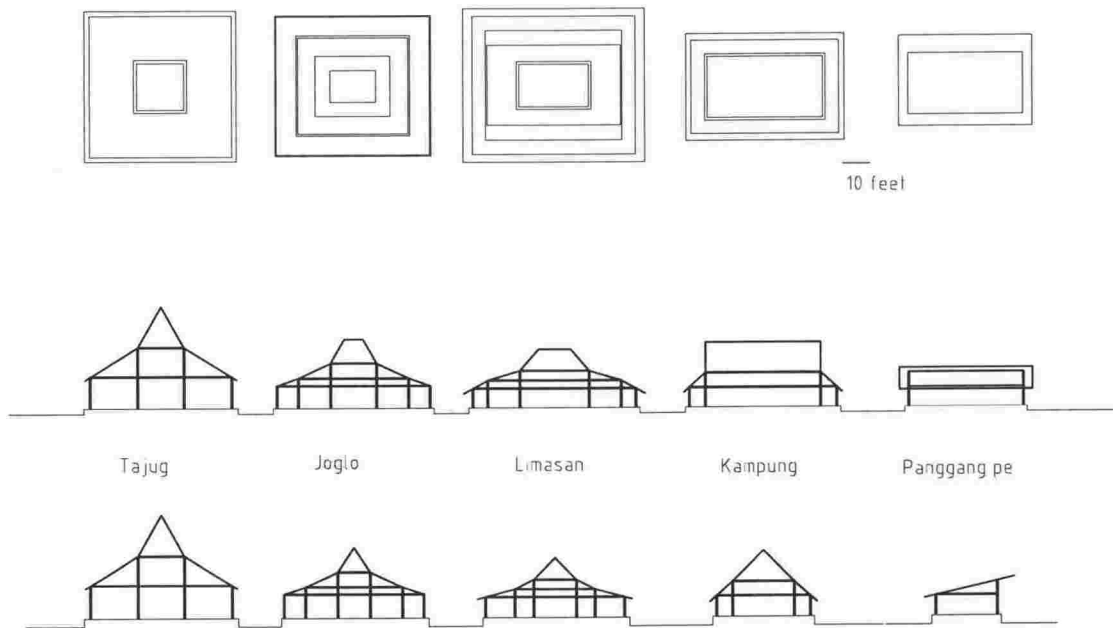

Figure 4-3 The five basic forms.

Table 4-1 Group of styles and their variants.

Group	Panggang pe	Kampung	Limasan	Joglo	Tajug
Variant	<ul style="list-style-type: none"> • Panggang pe pokok • Panggang pe gedhang selirang • Panggang pe empyak setangkep • Panggang pe gedhang setangkep • Panggang pe cere gancet • Panggang pe trajumas • Panggang pe barengan 	<ul style="list-style-type: none"> • Kampung pokok • Kampung pacul gowang • Kampung serotong • Kampung dara gepak • Kampung klabang nyander • Kampung lambang teplok • Kampung lambang teplok semar tinandhu • Kampung gajah njerum • Kampung ceregancet • Kampung semar tinandhu 	<ul style="list-style-type: none"> • Limasan pokok • Limasan lawakan • Limasan gajah ngombe • Limasan gajah njerum • Limasan apitan • Limasan klabang nyander • Limasan pacul gowang • Limasan gajah mungkur • Limasan ceregancet • Limasan lambang teplok • Limasan semar tinandhu • Limasan trajumas lambang gantung • Limasan trajumas • Limasan trajumas lawakan • Limasan lambang sari • Limasan sinom lambang gantung rangka kutuk ngambang 	<ul style="list-style-type: none"> • Joglo pokok • Joglo limasan lawakan • Joglo sinom • Joglo jompongan • Joglo pangrawit • Joglo mangkurat • Joglo semar tinandhu 	<ul style="list-style-type: none"> • Tajug pokok • Tajug lawakan • Tajug lambang teplok • Tajug semar tinandhu • Tajug lambang gantung • Tajug semar sinongsong lambang gantung • Tajug mangkurat • Tajug ceblokan

Note: Other variants may exist, but their absence reflects a lack of documentation in textbooks.

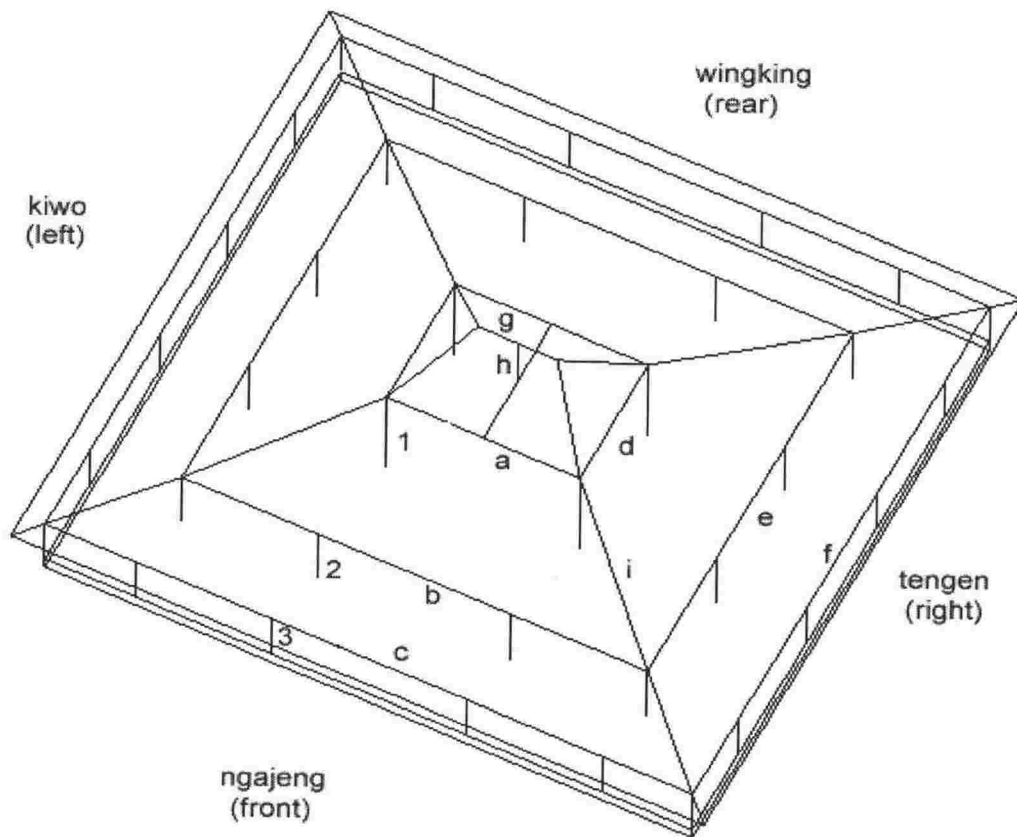
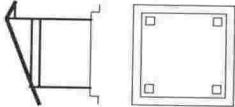
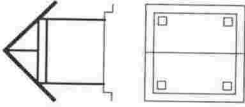
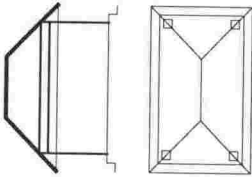
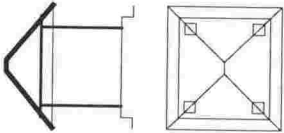
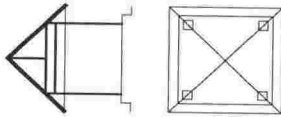
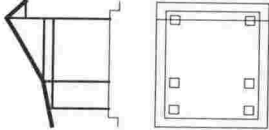
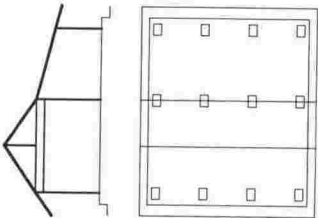
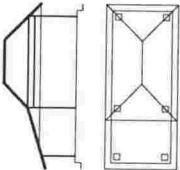
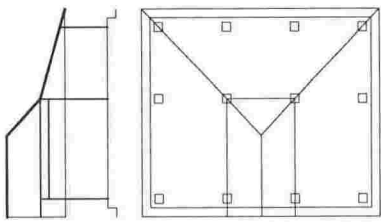
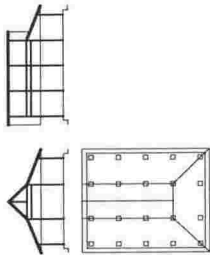
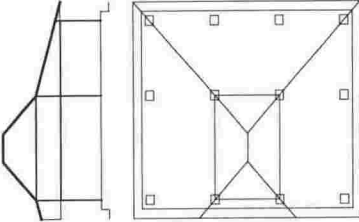

Figure 4-4 Parts of Javanese building structure

1. *Saka guru* (guru posts)
 2. *Saka pananggap* (pananggap posts)
 3. *Saka panitih* (panitih posts)
-
- a. *Blandar guru pamanjang* (long guru beam)
 - b. *Blandar pananggap pamanjang* (long pananggap beam)
 - c. *Blandar panitih pamanjang* (long panitih beam)
 - d. *Blandar guru panyelak* (short guru beam)
 - e. *Blandar pananggap panyelak* (short pananggap beam)
 - f. *Blandar panitih panyelak* (short panitih beam)
 - g. *Molo* (ridge)
 - h. *Ander* (king post)
 - i. *Dudur* (hip)

Table 4-2 Forms of Javanese Buildings.

Variant	Panggung Pe	Kampung	Limasan	Joglo	Tajug
<p>Panggung pe pokok; Kampung pokok; Limasan pokok; Joglo pokok; Tajug pokok</p>					
<p>Panggung pe gedhang selirang; Kampung pacul gowang; Limasan gajah ngombe</p>					

<p><i>Limasan gajah mungkur</i></p>				
<p><i>Kampung gajah njerum; Limasan gajah njerum</i></p>				

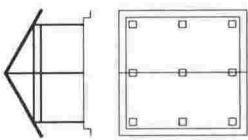
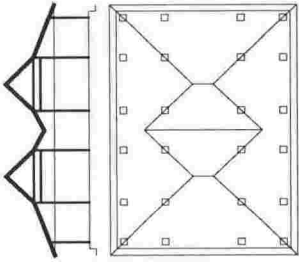
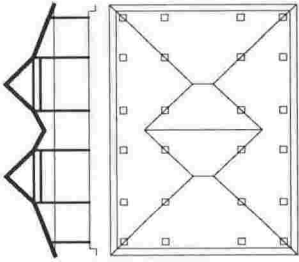
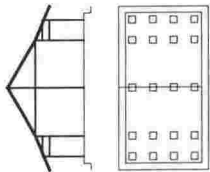
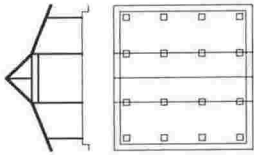
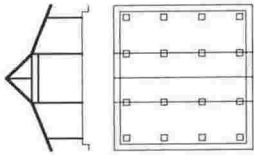
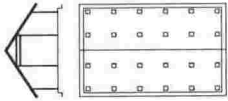
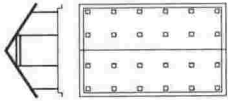
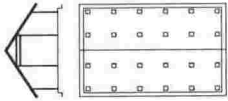

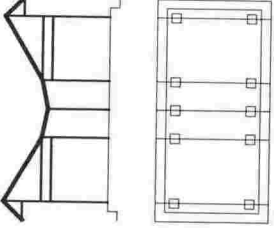
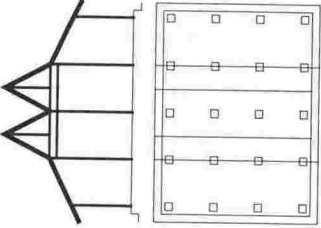
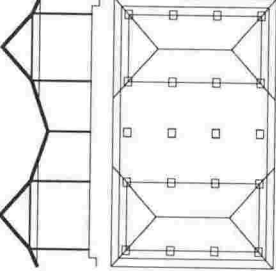
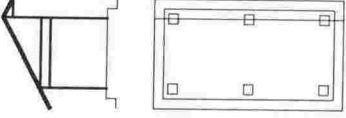
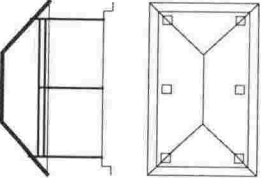
<p><i>Panggung pe empyak setangkep; Limasan apitan pengapit</i></p>				
<p><i>Panggung pe gedhang setangkep; Kampung serotong;</i></p>				
<p><i>Kampung klabang nyander; Limasan klabang nyander</i></p>				

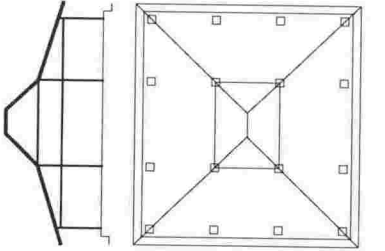
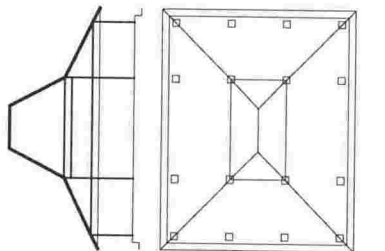
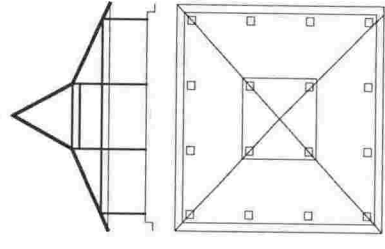
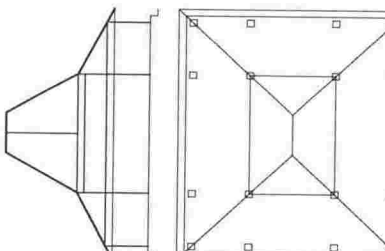
<p><i>Panggang pe ceregancet; kampung ceregancet; limasan ceregancet</i></p>					
<p><i>Panggang pe trajumas; Limasan trajumas</i></p>					

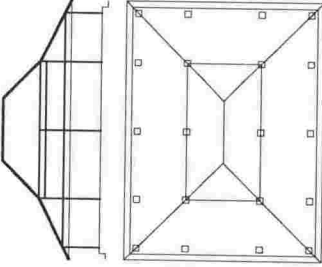
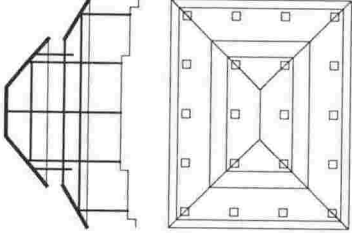
<p><i>Limasan lawakan; Jogo jompongan; Tajug lawakan</i></p>					
<p><i>Joglo limasan lawakan</i></p>					

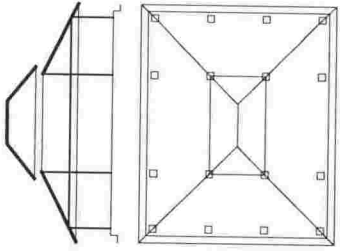
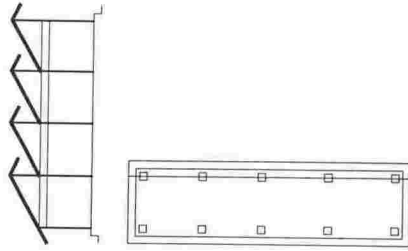
<p><i>Limasan trajumas lawakan</i></p>				
<p><i>Limasan trajumas lambang gantung</i></p>				

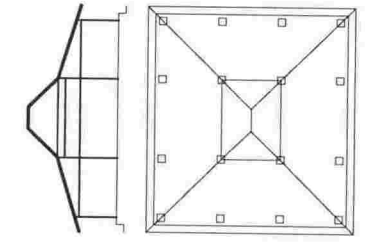
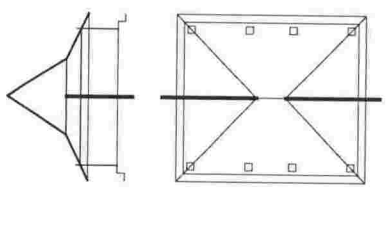
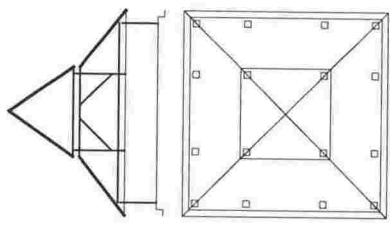
<p><i>Limasan lambang sari</i></p>			
<p><i>Panggung pe barengan</i></p>			

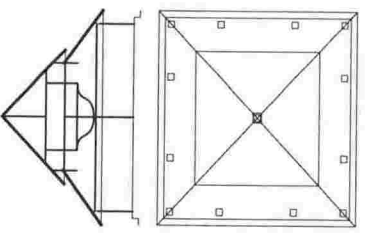
<p><i>Kampung semar pinodhong /tinandhu; Limasan semar tinandhu; Joglo semar tinandhu; Tajug semar tinandhu</i></p>			
<p><i>Tajug semar sinongsong lambang gantung</i></p>			

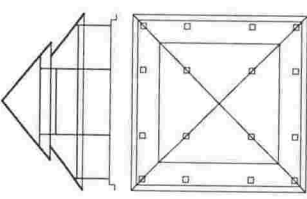
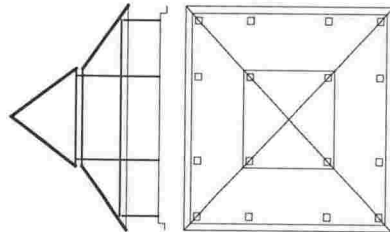
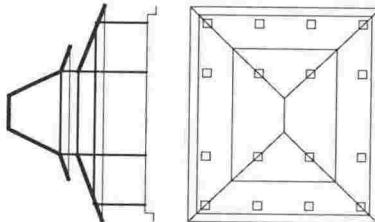
<p>Tajug lambang gantung</p>				
<p>Kampung lambang teplok; Limasan lambang teplok; Tajug lambang teplok</p>				

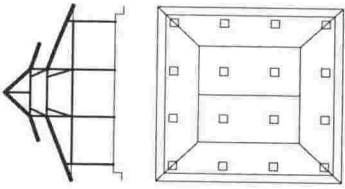
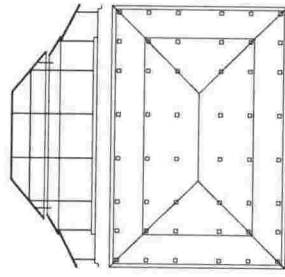
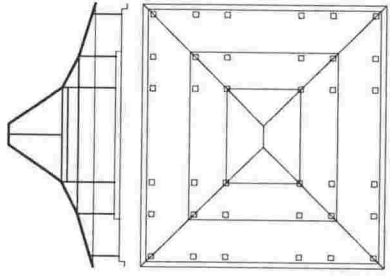
<p><i>Kampung lambang tepok semar tinandhu</i></p>				
<p><i>Limasan sinom lambang gantung rangka kutuk ngambang; joglo sinom</i></p>				

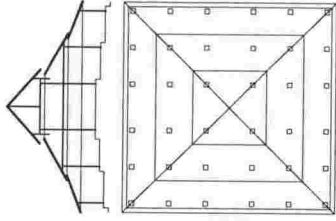
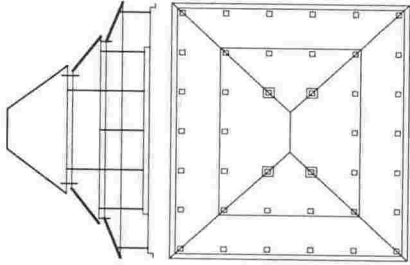
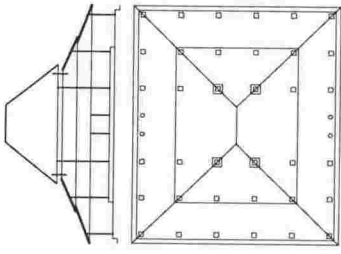
	
	
<p><i>Joglo pangrawit</i></p>	<p><i>Joglo mangkurat; Tajug mangkurat</i></p>

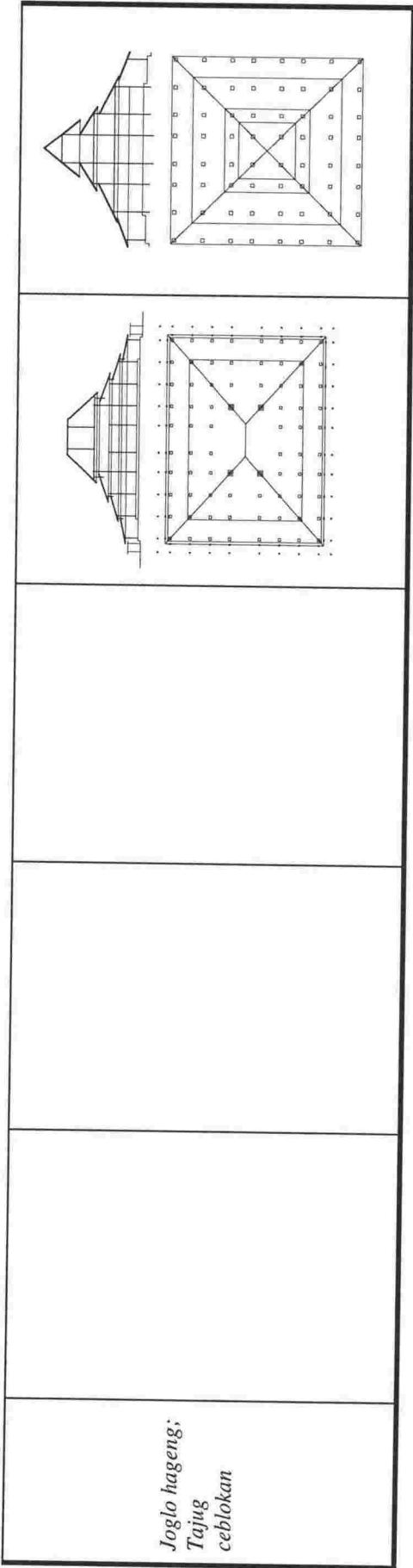

4.4 Javanese Architecture and Orders

Javanese architecture is guided by traditional orders, handed down through generations. Some orders survived through oral instruction and others in well-organised scripts. Some orders are considered general guides, while others are specific. Among the latter is a sort of numerology called *petungan*. In detail, it defines the dimensions of roof and frame structural components. Many references discuss *petungan*. They can be categorised into three groups: *Primbon*, *Serat Centhini* and *Kawruh Kalang*. Some have been translated into Indonesian, but many remain in the old style Javanese language and alphabet, which are very difficult to understand for most people. Prijotomo has published an important book on the subject, which summarised the old texts; this book has become the primary source of information on *petungan* in this research.

4.4.1 *Petungan* in Javanese Architecture

Clifford Greetz describes *petungan*, in general, as numerology.¹⁷ In terms of Javanese architecture, it is a method of dimensioning and calculation, giving spiritual values to Javanese buildings and relating the physical buildings to their effect on the owner.

Petungan in Javanese architecture can be considered as traditional orders. They are found in many Javanese texts, such as *Primbons*, *Serat Centhinis*, and *Kawruh Kalangs*. Originally written in Javanese (and using the Javanese alphabet), some have been translated into Indonesian, using the standard alphabet.

- *Primbons*: books covering various subjects, such as cookery, but also containing some guidelines for building. Examples of primbons are *Primbon Sabda Pandita*, *Primbon Jawa Makara*, *Primbon Jawa Pandita Sabda Nata* (translated 1976), and *Primbon Betaljemur Adam Makna* (translated 1982). Primbons resemble building manuals, as they mostly give direct guidelines as to what should be done when building a house.
- *Serat Centhinis*: works of Javanese literature also containing discussions of *petungan*. They include *Serat Centhini I* (translated 1986) and *Serat Centhini III* (translated 1986). These works were written in the styles of Javanese songs and poetry.
- *Kawruh Kalangs*: Javanese manuscripts on buildings. Examples are *Kawruh Kalang Mangoendarma* (written 1906), *Kawruh Kalang Soeparmo Kridosasono* (written 1976), *Kawruh Kalang Soetoprawiro* (written 1907), and *Kawruh Kalang Kapatihan Surakarta* (written 1882). These were written in prose style and contain most of the knowledge on Javanese buildings. The most complete example is *Kawruh Kalang Kapatihan Surakarta*.

Primbons and *Serat Centhinis* discuss *petungan* for other purposes and not exclusively for building. *Kawruh kalangs*, on the other hand, are particularly related to building and architecture.

Petungan is generated from three different approaches, which should be isolated to avoid misapplication; they should not be confused. These three approaches are:

- *peruntukan* or building function (an approach related to the function of the building, for example *Pendapa*/semi-public multi-purpose space, *Dalem*/living space, or *Gandokl* pavilion),
- *perwatakan* or building character (an approach considering the character of the building, for example wealthiness or sacredness), and
- *tipe* or building style (a stylistic approach to the building, such as *Joglo*, *Limasan*, or *Tajug*).

Functional approaches are used by *primbons*, *serat centhinis*, and *kawruh kalangs*. *Primbons* do not use a stylistic approach but give more stress to building characteristics. On the other hand, *kawruh kalangs* emphasise style over character.¹⁸

4.4.2 Targets of *Petungan*

Petungan covers wide-ranging physical and spiritual aspects. In terms of the physical it prescribes how to choose a site, locate the gate, place doors, and even the number of rafters. Spiritually, it guides everything from the very start of the construction process (eg. from selecting the best day to cut a tree to the ritual to accompany it) to the post occupancy process (eg. giving offerings before renovating the building). In this research, discussion of *petungan* will be limited to roofs, walls and floors.

4.4.3 Units and Modules in *Petungan*

Formerly, *petungan* was based on anthropometric units named *pecak* (from the toe tip to the heel), *asta* (from the middle finger's tip to the elbow), and *depa* (from one middle finger's tip to the other when arms are stretched). These units differ from one building to another, being based on the owner's or builder's body. Later, some estimate during the eighteenth century, building assumed more standardised units, named *kaki* (foot), *dim* (inch), and *setrip* (fraction).

Petungan can be expressed as:

$$Y = Xn + p, \text{ where}$$

- Y is the length of the building parts (main posts, beams, etc.)
- X is the module; this varies according to the source being used, different texts produce different modules. One of the most common modules is the four-five module of *sri*, *kitri*, *gana*, *liyu*, *pokah*.
- n is any integer number.
- p is any number from 1 to X; this is the number of unit(s) left after Y is divided by X. p determines the spiritual value of the object. It can be

measured in *pecak* (the size of the building owner's or the builder's foot) or in feet.

A widely used module is module five, constructed from five sequential units; each unit having a specific name, meaning and effect. Those are *sri*, *kitri*, *gana*, *liyu* and *pokah*, which are units one, two, three, four, and five respectively.

This can be applied through examples:

A post is 26 feet long or $Y = 26'$. If module five is used as the basic module and feet is used as the basic unit, then

$$Y = Xn + p$$

$$26 = (5)5 + 1$$

By having $p=1$, the post has the spiritual value of *sri*.

A beam is 28 feet long or $Y = 28'$. If module five is used as the basic module and feet is used as the basic unit, then

$$Y = Xn + p$$

$$28 = (5)5 + 3$$

By having $p=3$, the beam has the spiritual value of *gana*.

Commonly, the calculation begins by determining the function of the building. For example, a building used as a *dalem* (*omah mburi*, the part of house to live in) should have a spiritual value of *sri* (p has to be 1). The length of a beam can be found by substituting to the formula

$$Y = Xn + p$$

$$Y = (5)n + 1$$

The value of n is somewhat flexible. If $n=6$, then $Y=31$; the beam is 31 feet long. If $n=5$, the beam will be 26 feet long.

The detailed pattern of the 26 feet long beam is:

sri, kitri, gana, liyu, pokah; sri, kitri, gana, liyu, pokah; sri, kitri, gana, liyu, pokah;

X1

X2

X3

sri, kitri, gana, liyu, pokah; sri, kitri, gana, liyu, pokah; sri

X4

X5

p

Thus, the beam has *sri* value.

If the beam is 27 feet long, it has *kitri* as its pattern:

<u><i>sri, kitri, gana, liyu, pokah</i></u>	<u><i>sri, kitri, gana, liyu, pokah</i></u>	<u><i>sri, kitri, gana, liyu, pokah</i></u>
X1	X2	X3
<u><i>sri, kitri, gana, liyu, pokah</i></u> ; <u><i>sri, kitri, gana, liyu, pokah</i></u> ; <u><i>sri, kitri</i></u>		
X4	X5	p

Any additional inches are rounded up to the nearest foot measurement. For example, 25'6" is considered as 26'; and 27'4" as 28'. The length of a beam can be altered freely, as long as its spiritual value is not changed. This is usually done by adding one or more modules. Beams of 26', 31', 36' length will have the same spiritual value, *sri*, as long as they use a module of five: *sri, kitri, gana, liyu, pokah*. (Note: there are different modules available. Modules used will depend on the owners' decision, but they should be used consistently.)

Figure 4-7 shows that different geometry can have the same value; Figure 4-8 illustrates how the same configurations can have different meanings (p).

The formula $Y=Xn+p$ has two effects. The values of Xn range from one whole module up, the values of p range from 1 to one whole module. In ordinary buildings the proportion of $Xn:p$ can be significant. A building of 43' by 23' has the proportion of $Xn:p$ as 40:3 and 20:3 respectively. Prijotomo states that, proportionately, Xn is more significant in forming the shape of the building; p assigns a spiritual value.

4.4.4 Application of *Petungan* on Roofs

Javanese architecture places much attention on roof design. *Petungan* provides detailed information on almost any components of the roof and its construction, especially at the *guru* sector. (See Figure 4-4 for the names of roof parts; see glossary for the explanation of these parts and their informal English translation; see Figure 4-2 for the names of the sectors.)

The effects of *petungan* on roofs design can be derived from its $Xn+p$ formula. As mentioned, Xn has more influence in roof formation than p . The bigger the integer n the smaller the effect of p . For example, X is module five and p is one (*sri*). If $n=1$ then the length of the object will be 6'. Thus, p is 1/6 or 16% of the length. If $n=10$, the length of the object will be 51'. In this case p is 1/51 or 0.019% of the length. The bigger the object, the smaller the percentage of p relative to the whole length, allowing it to be ignored.

Table 4-3 Name and meaning of units in *petungan*.

P	name	meaning and objectives	application and objectives
1	<i>Sri</i>	food, precious goods , happiness, beauty <i>Dewi Sri</i> (the goddess of happiness)	<i>dalem</i> , the main family living area. <i>Sri</i> ensures a good life, materially and spiritually.
2	<i>Kitri</i>	trees, strength, shelter; open, peacefulness	<i>pendapa</i> , a place to welcome and entertain guests, a semi-public space for meetings, <i>pringgitan</i> , a place to perform with leather puppets, usually played at night. <i>Kitri</i> hopes for the peaceful, and stressless resolution of problems.
3	<i>Gana</i>	form, performance	<i>gandhok</i> (pavilion), <i>pawon</i> (kitchen), <i>kandhang</i> (domestic animal's house). <i>Gana</i> is associate with the hope that the contents will be safe and even grow in numbers.
4	<i>Liyu</i>	hope for goodness, tired, eliminate bad willing, going through	<i>regol</i> (gates), <i>bangsal</i> . <i>Liyu</i> eliminates any bad intentions by people (guests, etc.) who pass the gate, and also hopes for goodness.
5	<i>Pokah</i>	multiplication	<i>lumbung</i> (rice store). <i>Pokah</i> hopes that the buildings' contents will develop and grow in numbers.

Note: The above table has a building-function approach, not a building-type approach. Thus, a building used as a house can be of any style (*kampung*, *limasan*, or *joglo*), but should have its dimensions fall to *sri*.

4.4.5 Application of *Petungan* on the Main Frame

The most significant part of building to be affected by *petungan* is the main frame of the *guru* sector. This part contains four main posts (*saka guru*), two long beams (*blandar pamanjang*), and two short beams (*blandar panyelak*). These parts should follow (X_n+p) . While the values of p should be the same for all parts of a building, the values of X_n can vary. However, the ratio between long and short beam is usually specific for each type of building.

A study by Prijotomo found that *petungan* is only strictly followed at *guru* sectors whereas at other sectors (*pananggap* and *panitih* sectors) it is not always followed.¹⁹ He also noted that from *pananggap* to *panitih* sectors the ratios of length and width tend toward 1:1, or a square proportion.

Table 4-4 Dimensions of sectors and their p values.²⁰

	<i>Tajug</i> (mosque)	<i>Joglo</i> (pendapa)	<i>Limasan</i> (dalem)	<i>Kampung</i> (gandhok/pawon)
<i>Guru</i> sector beams dimensions (Xn+p) n:n name of p	(178)/(178) (5x3+3)/(5x3+3) (3):(3) or 1:1 <i>gana/gana</i>	(17)/(12) (5x3+2)/(5x2+2) (3):(2) <i>kitri/kitri</i>	(26)/(16) (5x5+1)/(5x3+1) (5):(3) <i>sri/sri</i>	(43)/(23) (5x8+3)/(5x4+3) (8):(4) or 2:1 <i>gana/gana</i>
<i>Pananggap</i> sector beams dimensions (Xn+p) n:n name of p	(53'4)/(53'4) (5x10+4)/(5x10+4) (10):(10) or 1:1 <i>liyu/liyu</i>	(41)/(36) (5x4+1)/(5x7+1) (4):(7) <i>sri/sri</i>	(50)/(30) (5x9+5)/(5x5+5) (9):(5) <i>pokah/pokah</i>	N/A
<i>Panitih</i> sector beams dimensions (Xn+p) n:n name of p	N/A	(57)/(52) (5x11+2)/(5x10+2) (11):(10) <i>kitri/kitri</i>	(61)/(52) (5x12+1)/(5x10+2) (12):(10) or 6:5 <i>sri/kitri</i>	(55)/(35) (5x10+5)/(5x6+5) (10):(6) or 5:3 <i>pokah/pokah</i>

Note:

- The table above recommends a match between types and functions of buildings (eg. *limasan* for *dalem*, *joglo* for *pendapa*) It should be noted that this is not always the case. Under building-function approaches, *dalems* can have *joglo*, *limasan* or *kampung* types.
- inches are rounded up to one foot
- N/A, Not Available
- Data on *Panggung* pe is not available

4.4.6 Application of *Petungan* on Walls

The form and dimension of walls (length and height) are directly affected by roof form (ie. The roof projection to floor) and the height of the *sakas* (main posts).

Apart from doors, openings do not appear very important. This may trace back to the past tendency of the Javanese to spend most of their time out of doors. Prijotomo argues the case of windows as a western importation.

There are some rules associated with locations of gates; these are the four-five and four-nine methods. The first method works by dividing the length of a wall plane into five sections. Each section carries a different spiritual value (See Figure 4-5). The second works by dividing the wall length into nine sections (See Figure 4-6). Each section bares a specific value.

The four-five method:

- 1 - good, safe
- 2 - much luck
- 3 - many constraints, misfortunate, poor
- 4 - often doubtful, shy
- 5 - bad, evil place, taboo

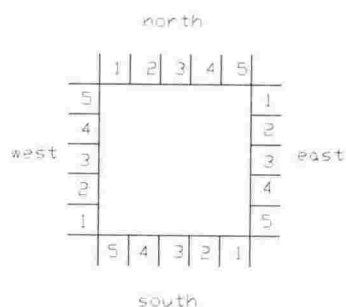

Figure 4-5 Four-five method

The four-nine method:

- 1 - tanah (earth), good
- 2 - kereta (chariot), good
- 3 - kala (ghost), bad
- 4 - sungai (river), bad
- 5 - tanah (earth), good
- 6 - kereta (chariot), good
- 7 - kala (ghost), bad
- 8 - sungai (river), bad
- 9 - tanah (earth), good

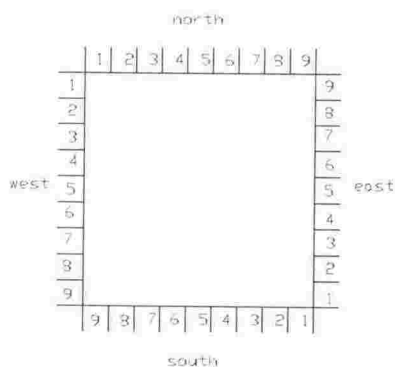

Figure 4-6 Four-nine method

These figures show that the same location can have different values. A door position at the middle of the wall, for example, has a negative value in the four-five method (3 - many constraints, misfortunate, poor) but has a positive value in the four-nine method (5 - tanah / earth, good).

4.4.7 Application of *Petungan* on Floors

Only limited information exists on floors; their areas and dimensions are almost directly dictated by roofs' projection to the ground. Floors are elevated at least 30 cm by soils, stones or bricks, and use various materials including bare condensed soils, stones, clay bricks, terrazzo, and marbles. As a common rule, people of lower status cannot apply the same materials used by people of a higher status. Floors tend to utilise locally available materials. In the countryside of Wonosari, Gunung Kidul regency, for example, floors are commonly made of gypsum as this area has gypsum hills.

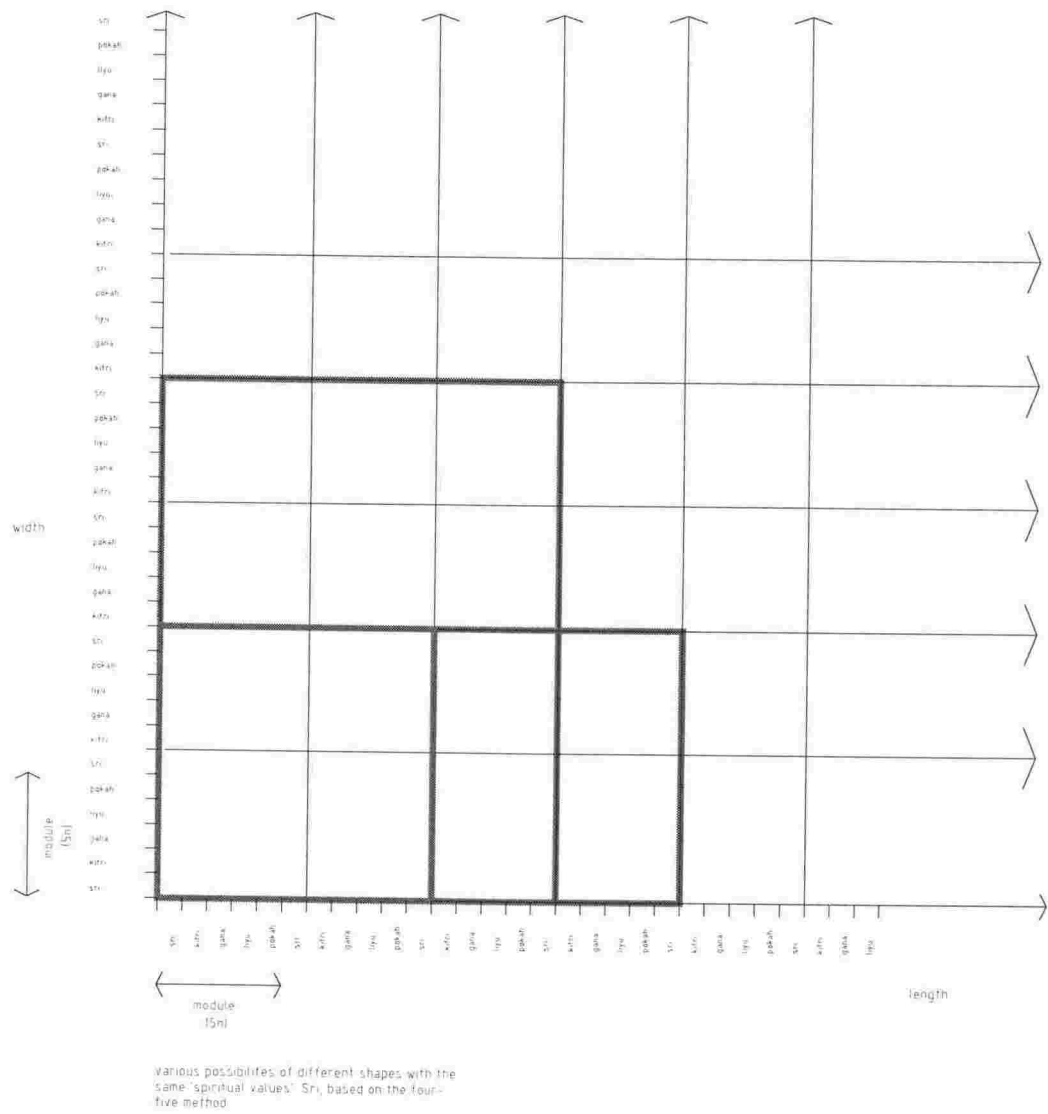

Figure 4-7 Examples of some different forms with the same spiritual values.

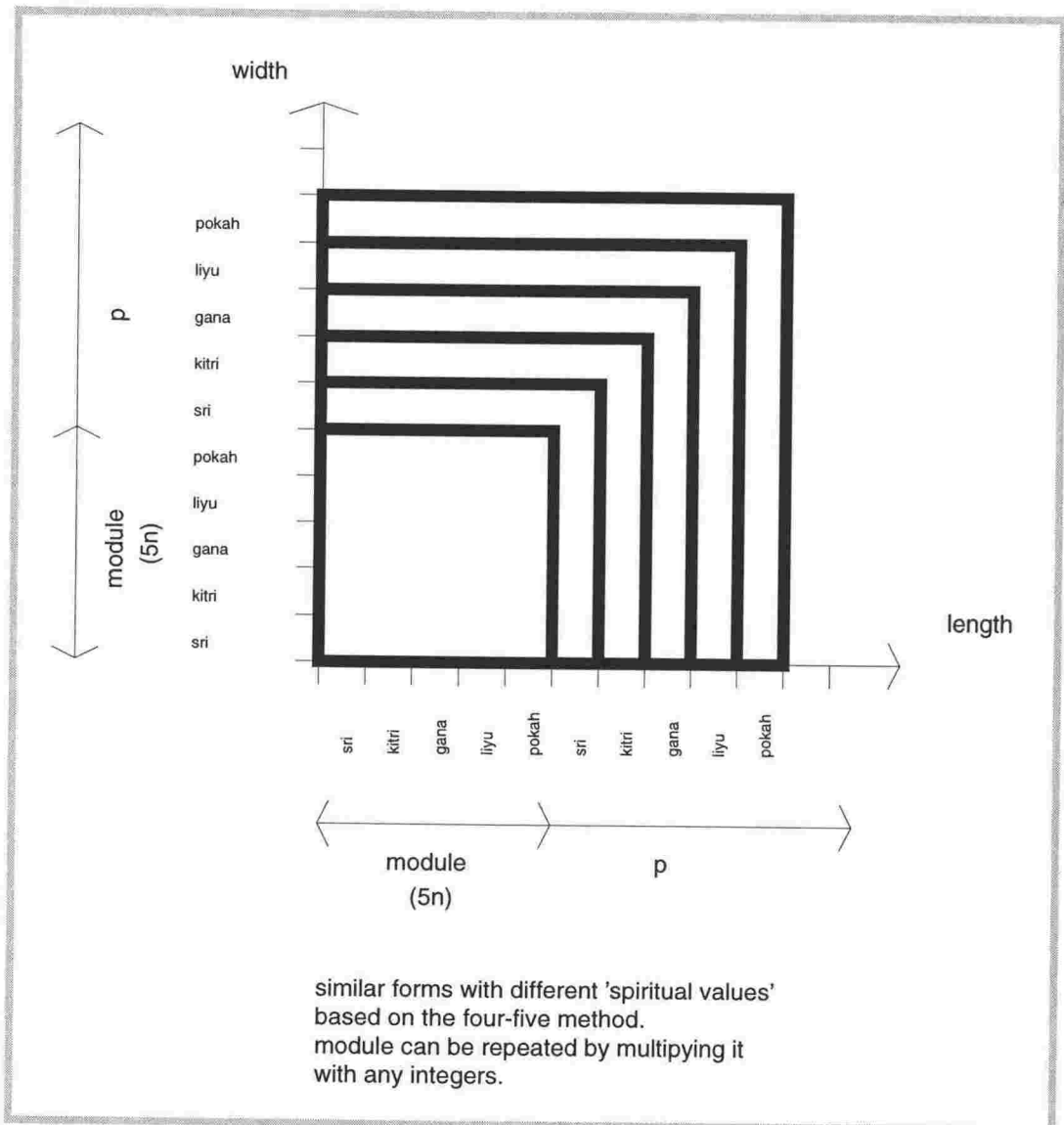

Figure 4-8 Examples of some similar forms with different spiritual values.

4.5 Summary

- Javanese architecture is guided by both general and specific rules. The former creates the general sense of Javanese architectural style, while the latter assigns it spiritual value.
- Javanese architecture styles can be categorised into five groups: *Tajug*, *Joglo*, *Limasan*, *Kampung* and *Panggung Pe*. The last style, *Panggung pe*, is not recognised in old literature. From these five basic forms, more than 47 variants can be identified.
- Javanese buildings are divided into three concentric sectors: *guru* (the innermost), *pananggap*, and *panitih*.
- *Petungan* of the four-five method (*sri*, *kitri*, *gana*, *liyu* and *pokah*) is the most popular. Its application is compulsory for the dimensions of the *guru* sector of a roof.
- The application of *petungan* should not ignore aesthetic values, particularly proportional

consideration. Therefore, when a *petungan* value can result in more than one possible form, aesthetic considerations can be used to determine the final design choice.

- The effect of applying *petungan* to the whole geometry of the building is slight. It is primarily intended to assign spiritual value to the buildings. The selection of *petungan* is based on the building's function.

The following chapter (Chapter Five) discusses Javanese residential buildings in detail.

Endnotes

¹ Silas, J., --, Arsitektur Jawa atau Rumah Jawa, Yogyakarta: Proyek Javanologi, p.4.

² Wiryatmaja, S., 1986, Pengetahuan Bangunan Rumah Tradisional Jawa (Pengetahuan Kalang), Departemen Pendidikan dan Kebudayaan - Direktorat Jendral Kebudayaan, Proyek Penelitian dan Pengkajian Kebudayaan Nusantara (Javanologi), p.13.

³ Ibid., p.16.

⁴ Hamzuri, 1982, Rumah Tradisional Jawa, Jakarta: Dep. Pendidikan dan Kebudayaan, p.83.

⁵ Ronald, A., Santoso, M., Saragih, S., 1987, Joglo Buildings - A Study of Construction, Proportion and Structure of Royal Houses in Yogyakarta, Yogyakarta: Department of Architecture, Engineering Faculty, Gajah Mada University, p.53.

⁶ Wiryatmaja, S., op.cit., p.30.

⁷ Ibid., p.29.

⁸ This picture was taken from <http://www.kn.pacbell.com/wired/art/leonardo.man.html>

⁹ Ismunandar, K., 1993, Joglo - Arsitektur Rumah Tradisional Jawa, Semarang: Dahara Prize.

¹⁰ Hamzuri, loc. cit., p.83.

¹¹ Dakung, S., 1981, Arsitektur Tradisional Daerah Istimewa Yogyakarta, Yogyakarta: Departemen Pendidikan dan Kebudayaan.

¹² Prijotomo, J., 1995, Petungan: sistem Ukuran dalam Arsitektur Jawa, Yogyakarta: Gadjah Mada University Press.

¹³ Wiryatmaja, S., loc. cit., p.29.

¹⁴ Mc.Luhan, M., 1964, Understanding Media, New York: New American Library.

¹⁵ _____, 1977, Sejarah Daerah Istimewa Yogyakarta, Departemen Pendidikan dan Kebudayaan, Pusat Penelitian Sejarah dan Budaya, Proyek Penelitian dan Pencatatan Kebudayaan Daerah, p.51.

¹⁶ Prasodjo, T., 1988, Relief Rumah pada Candi di Jawa, Sebuah Gambaran Rumah Jawa pada abad IX - XVI Masehi, unpublished research report, Faculty of Literature, Gajah Mada University.

¹⁷ Geertz, C., 1960, The Religion of Java, London: The University of Chicago Press.

¹⁸ Prijotomo, op.cit., p.93.

¹⁹ Ibid., pp.110-111.

²⁰ Ibid., p.111.



5

5. JAVANESE RESIDENTIAL BUILDINGS

5.1 Introduction

This chapter considers the present condition of Javanese buildings as found during the field research. It focuses on ordinary residential buildings, rather than regal buildings; this research emphasises the physical aspects of traditional Javanese domestic architecture. Data relating to the philosophical aspects of this research is derived from existing reference material. Most of this material is based on interviews with traditional builders, studies of traditional buildings, as well as translated ancient texts, such as *Primbon*, *Serat Centhini*, and *Kawruh Kalang*.^{1,2} This examination of Javanese architecture combines field study analysis, literary exploration, and interviews with experts.³

Focussed as it is on ordinary domestic architecture, this study generally deals with building styles for the *lurah* level. These were selected as they are commonly midway between being too simple (as poor peasants' abodes) and too complicated (as rich royal relatives' palaces).

A field study of the ten Javanese buildings is useful in understanding Javanese building designs in the real world. Combined with study of references and literature, it allows a more complete understanding of Javanese buildings, to be used, in turn, in theoretical approaches to thermal comfort performance (Chapter Six). The number of the buildings studied was limited by the time allocated for field research, the physical condition of the available buildings, and their accessibility. Since the ten buildings are in relatively the same physical condition, conclusions drawn from the collected data is sufficient to be able to represent the other corresponding Javanese buildings.

The general structure of the discussion in each sub-chapter includes the introduction (briefly describing the *thoughts* or *rules* behind traditional designs), summaries of field observations, and the results of the theoretical analyses of ten case studies. Of the ten Javanese buildings studied, four are within the urban centre with the remainder in a rural setting.

5.2 Styles

Style is dictated both by economic conditions and social status. The richer the owners, the better their buildings tend to be. However, no one, regardless of wealth, is permitted to imitate the Sultan's palace.⁴ People of lower class or status cannot build styles of buildings used by higher-class people.

In Javanese architecture there is a standard house configuration consisting of some individual buildings called *pendapa*, *peringgitan*, *dalem*, *gandok*, *dapur*, and *kamar mandi*, within an enclosed area, or a complex. Usually, those six buildings constitute a house. The rich may have more facilities such as *lumbung*, *kandang jaran*, and *musholla*. On the other hand, it is not uncommon for the poor to only have a *dalem* as their house. Figure 5-1 shows the basic configuration of a Javanese building with *pendapa* and *peringgitan*. Figure 5-2 shows a typical complex of Javanese buildings, consisting of many individual structures.

The *dalem* has the highest priority in terms of constructing the house. Logically, the *dalem* is the core (basic) element of a Javanese house.⁵ Failure to build this first increases the risk of not having a house at all, if, for example, financial problems occur during the construction.

Kampung, *Limasan* and *Joglo* are the most favoured styles of houses; *Tajug* and *Panggung Pe* are commonly used for religious and market buildings respectively.

This research focuses on two styles of Javanese buildings, *Limasan* and *Joglo*, suitable for the status of *lurah* or community leader. He holds the lowest position in the governmental structure of the Sultanate and is given limited authority.⁶ The *Limasan* and *Joglo* are considered the most preferred styles for traditional residential buildings and have the following room division: *dalem*, *senhong kiwo*, *senhong tengah*, and *senhong tengen*. Family members spend their indoor leisure time in *dalem*. *Dalem* can be considered as the favourite space in which to live. *Limasan* and *Joglo* can still be readily found in Yogyakarta Special Region.

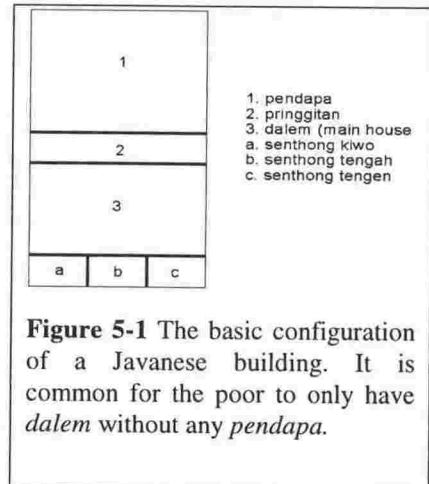

Figure 5-1 The basic configuration of a Javanese building. It is common for the poor to only have *dalem* without any *pendapa*.

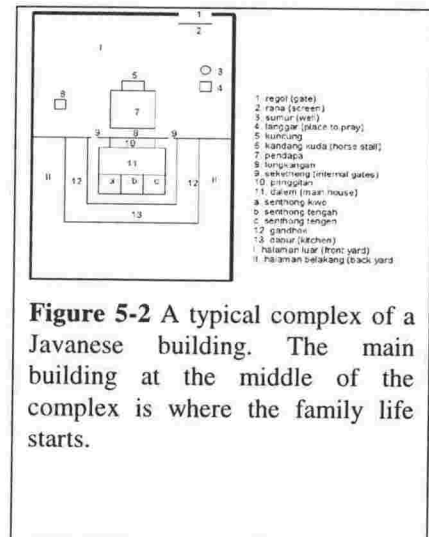

Figure 5-2 A typical complex of a Javanese building. The main building at the middle of the complex is where the family life starts.

5.3 Traditional Building Design and Orders

As mentioned, Javanese architecture has very complicated orders, relating to *petungan* (numerology). It acts as a guide for builders, and should be followed to guarantee either safety during construction, as well as the future prosperity of the owners. It relates the physical aspects of the building and their spiritual performance, ultimately affecting the occupants' behaviour.

Orders in Javanese traditional architecture are closely linked to supernatural beliefs and religion. There is no explicit indication that these orders were consciously related to enhancement of the physical performance of buildings, as in thermal comfort and mechanical strength. Some studies have been conducted to find the physical performance of Javanese designs. Ronald, Santoso, and Saragih studied the performance of *soko guru* (the four main posts in *Joglo*) within

royal houses, finding that *Joglo*'s construction is redundant. It is 300 to 700% stronger than it needs to be.⁷ Ronald's structural analysis reveals material efficiency not to have been a factor in construction. In other words, buildings designed according to Javanese tradition will yield structures of different strengths than designs based on modern theory.

5.4 Landscape

Landscape is important to Javanese architecture. Javanese buildings were designed to stand separately from each other. The complicated *petungan* of the landscape was invoked before any construction could begin. *Petungan* in landscaping is affected by the quality and position of the site, the smell and taste of the soil, the quality of the water, and the air, all of which are believed to influence the owners' social interaction, prosperity, etc.⁸ *Petungan* directs the arrangement of



Figure 5-3 A typical scene of Javanese buildings in the villages. It is a stand-alone building with relatively wide front yard, surrounded by trees. Commonly, yards are left uncovered, although wild grasses might grow sparsely.

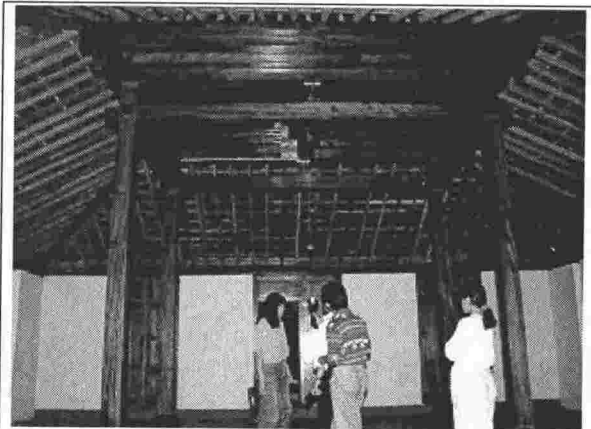

Figure 5-4 Redundant construction of *tumpang sari*. Its actual strength is 300 to 700% higher than it needs to be.

the site.

Planting is important both practically and symbolically. Ronald highlights that originally Javanese buildings were intended to be surrounded by big trees. The trees not only provided timber and fruit but also protected against excessive solar exposure and strong winds. Moreover, dense trees make the soil below humid, reducing dust which is considered one of the problems of tropical life. Javanese buildings in their original environments may not be subjected to any major dust problems.

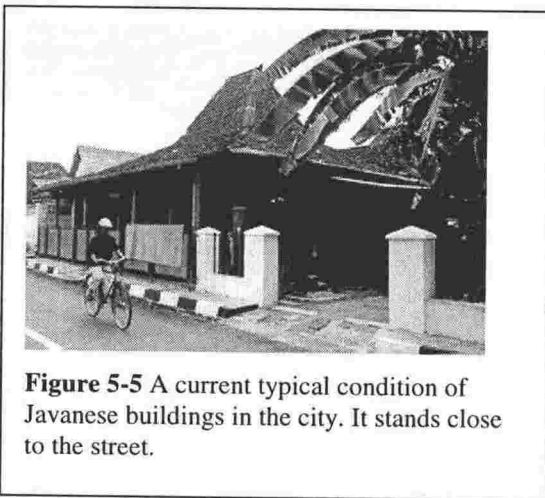

Figure 5-5 A current typical condition of Javanese buildings in the city. It stands close to the street.

Such urban developments as new roads and new buildings have changed the original environment around Javanese buildings. Field studies revealed that original buildings were constructed within large sites. A relatively wide front yard with big trees in front of *pendapa* in the middle of a crowded kampong reflects Javanese building in its original state. The need for housing has transformed most of these into sites for new individual houses. This is

particularly true for buildings in Yogyakarta, where the population density is very high. Buildings in the villages *maintain their dignity* in standing solitary in the middle of large sites surrounded by trees.

Rurally located Javanese buildings maintain their original environment better than those in the city. Four of the ten case study Javanese buildings are situated in dense Yogyakarta. Here, buildings have lost their side yards to neighbouring buildings. Sometimes neighbours' walls are adjoined, or shared. Neighbouring buildings become barriers to horizontal winds, the sun's rays and skylights, as well as to torrential rains.



Figure 5-6 A common view of kampong in Yogyakarta.⁹ Buildings attach to each other.

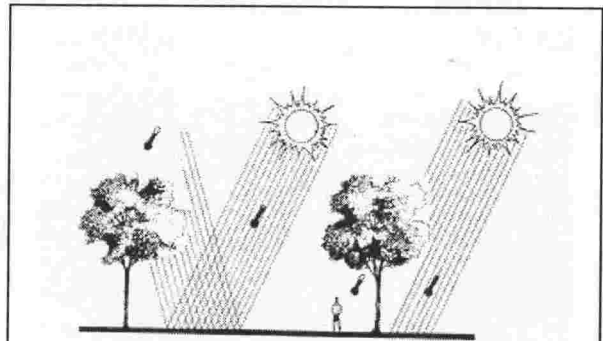

Figure 5-7 The wide and high canopy trees create a corridor for horizontal wind and screen from the sun direct radiation.¹⁰

New roads introduce new problems, as developing traffic systems demand wider and higher quality thoroughfares. Older inhabitants who still have good memories of the past, can tell the difference.¹¹ Although subjective, their opinions reveal a strong logic. They isolated significant issues introduced by new roads, including acoustic problems, feelings of insecurity, hotter air, brighter light, and a dustier environment.

Dust problems were found in most of the buildings. Owners claimed that cleaning their house is time consuming, not only because of large floor areas, but also the incessant presence of dust. This problem is far less intense in buildings situated in the Pakem area, where the air is cooler and humidity higher.

Despite the importance of greenery to Javanese architectural orders, landscape greenery is given less attention now than in the past. From the interviews with building owners, there appear to be two main reasons for this. First, people have less free time, as work hours have become less flexible. Second, fruits from trees as food source is no longer as important because of an abundant supply of varied and inexpensive fruits readily available in the markets. Additionally, grasses are not introduced in Javanese landscaping. Common trees found in the Javanese landscape are *Nangka* (Jackfruit), *Mangga* (Mango), *Kelapa* (Coconut), and *Jambu*.

Re-constructing past conditions, Javanese landscaping generally comprised of relatively wide surrounding yards (especially front and back yards), relatively broad and tall *canopy* trees, scattered shrubs and uncovered grounds.

Traditional texts do not consciously encourage scattered building configurations to

introduce better ventilation. The availability of land (combined with low population) and psychosociological considerations (such as personal dignity) might have been the most meaningful explanation for having wide yards around buildings. However, scattered configurations with

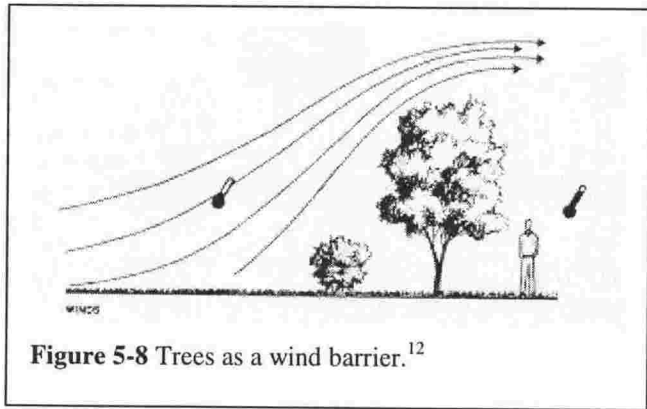

Figure 5-8 Trees as a wind barrier.¹²

open spaces are environmentally beneficial for hot humid regions. In these areas, sufficient airflow is the most important natural ventilation factor to induce physiological cooling. Outdoor air speeds in these climate regions are often low. Wide-open spaces around buildings optimise the physiological cooling effect of the weak horizontal airflow.

However, most Javanese buildings have relatively high roofs, calling into question the effectiveness of trees as shading devices. Also, many trees are grown at a distance from the buildings. Mangunwijaya writes that the distance can reduce the destructive effects of roots to building foundations and also avoid highly humid indoor air during the wet season.¹³ The shading effect of the trees might only be effective during early morning and late afternoon. During the day, it seems, densely foliated trees help keep the air temperatures underneath them slightly lower than those which are not shaded. When there is a horizontal airflow, this slightly cooler air is blown into the building lowering internal air temperature. In modern environmental design, this phenomenon is clearly explained by Robinette. Shaded air can be up to 8.3 °C lower than unshaded air.¹⁴

Unlike regions which have four seasons, in tropical climates most trees constantly have leaves. Even though they might produce fruits seasonally, the trees themselves are almost densely foliated. However, in an extraordinarily long dry season trees might shed some of their leaves.

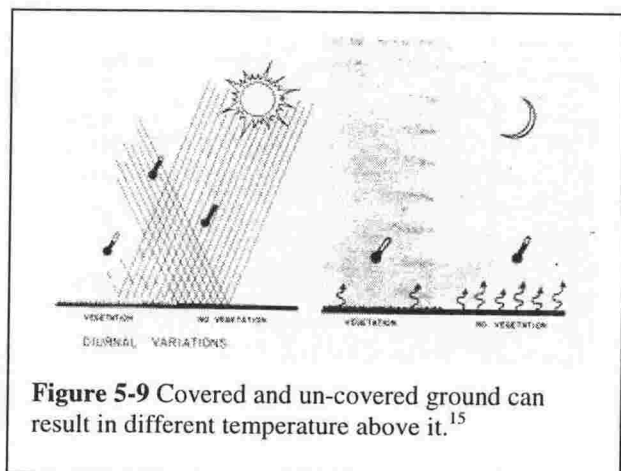

Figure 5-9 Covered and un-covered ground can result in different temperature above it.¹⁵

Grasses are not given any particular attention in the traditional Javanese landscape. This differs from modern landscape design, which recommends grasses to reduce dust problems. Dr Arya Ronald argues that the absence of grasses in Javanese landscapes does not reflect a lack of

concern with dust problems.¹⁶ Wide trees around Javanese buildings have effectively kept the soil below damp. The field study reinforced this, finding that they were not only providing shade but also releasing a sticky gelatinous substance as an assimilation by-product, which seems to bind dust particles.

5.5 Building

This sub-chapter focuses on the building.

5.5.1 Building Mass and Plan

Javanese houses consist of single room masses. Each mass almost always encloses a single room and has its own roof style. A building usually has an open plan; partitioning is not necessary. Buildings can stand-alone or be connected to each other by separated roofs. Sometimes those masses blend into each other, creating a single mass with a more complex plan. The single mass has various roof styles, which can identify the original masses: *peringgitan*, *dalem*, and *gandhok*. Geometrically, Javanese building plans consist of squares or rectangles; ovals and circles are not recognised.¹⁷

The very basic unit, which generates a residential building, is a single room building for all the family members. People living marginally tend to own this kind of building. It is usually divided into four spaces: *dalem*, *senhong kiwa*, *senhong tengah*, and *senhong tengen*. The *dalem* is used for the whole family; the *senhong kiwa* is the children's place; the *senhong tengah* reserved for spiritual objects; the *senhong tengen* belongs to parents. Arya Ronald relates that within traditional Javanese philosophy: *dalem* is a place for sharing family matters and dialogue; *senhong kiwa* is for the future life of a new generation and for decision making; *senhong tengah* relates to spiritual strength, as the basis for all decisions; *senhong tengen* is for personality and ownership. Figure 5-1 shows the basic design pattern of a residential building. A study by Emiliana found the assignation of *dalem* for women, girls and children, *gandhok kiwa* for female guests, and *peringgitan*, *gandhok tengen* and *pendapa* for male guests. Parents occupy the west side, whereas youngsters occupy the east.¹⁸

The house is placed centrally on the site. If possible, people build their first building near the middle of the site. Its exact position will be dictated by their spiritual consultant's recommendations. Extensions are then constructed around this first building.

In terms of massing, all ten buildings studied had, to some degree, been modified. Most modifications involved room additions or walls extension to facilitate new demands. Covering the courts (open spaces between the main building and adjacent buildings) is also a common

practice. Combining single mass buildings generates a more complex building. This can easily be seen from the various roofs covering one building.

Most of the ten case study Javanese buildings still maintain their original plan designs, particularly the *dalems*. Some rooms were used in a new way. *Senthong tengah*, for example,

originally designed for spiritual activities, has been used as a storeroom or bedroom. Most occupants, though, still sleep in the old style, preferring wide beds without permanent partitioning or only using linen as visual barrier.

Compared to the newer ordinary buildings around them (which start from 45 m²), traditional Javanese buildings are much larger. Even a relatively small building of basic configuration, consisting of *pendapa* and *dalem*, can occupy 200 m² of site excluding the front yard.

Currently, all ten case study buildings are occupied by a small number of people, ranging from one to four. Thus the building seems more spacious than it would have done when large families were more common. Owners (or house sitters) cite the reason for lowered occupancy rates being that people prefer modern style houses, even though smaller sized. Modern houses are considered more suitable to a modern lifestyle. They have many rooms, contemporary designs, modern materials, and relatively lower maintenance costs. The natural materials used in Javanese buildings require periodic renovation or renewal. This becomes prohibitive in years when timber and labour are expensive. The large floors need to be cleaned everyday, which is impractical for busy modern people.

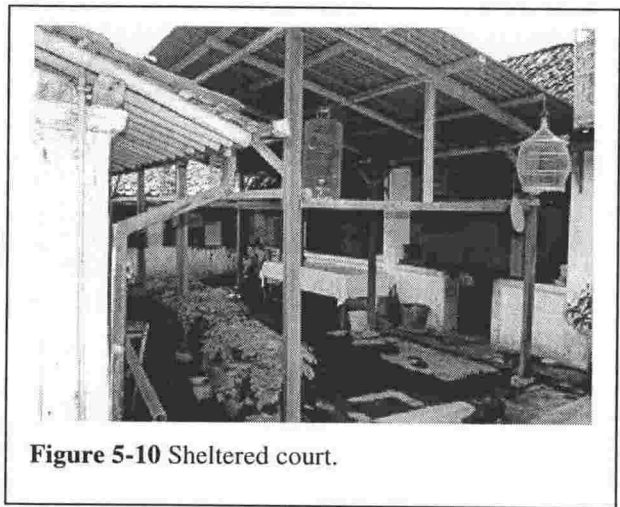

Figure 5-10 Sheltered court.

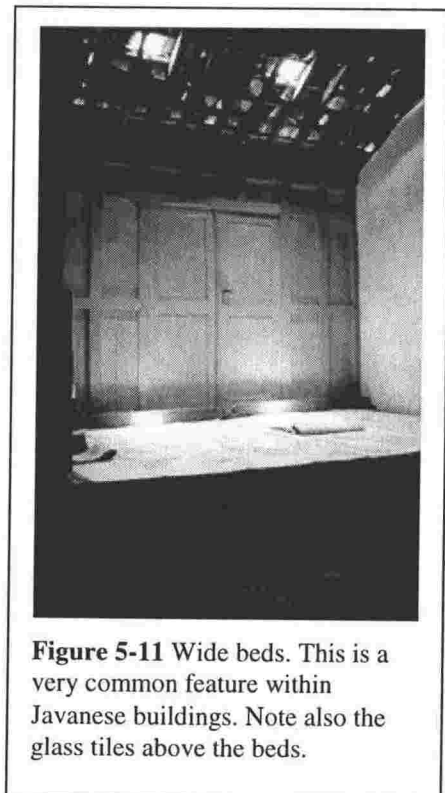

Figure 5-11 Wide beds. This is a very common feature within Javanese buildings. Note also the glass tiles above the beds.

There was obvious difficulty in reorganising the plan; all ten case study buildings had a poor plan redesign. The most obvious sign is a poor integration of the original plan design (the position of doors and windows, as well as the purpose of the spaces) and new furniture (cupboards for partitioning, clusters of furniture, etc.) (see Figure 5-13). A possible reason might be found in conflict between a desire to preserve the original design and the need to adjust to a new lifestyle.

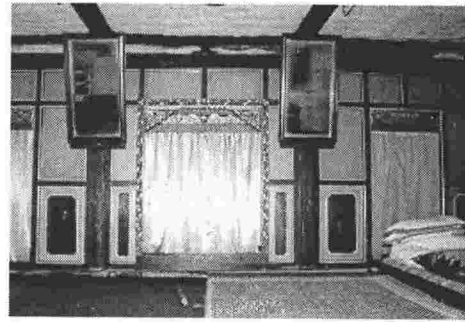

Figure 5-12 Linens cover *senthongs* as visual barriers.

In tropical climates, the central positioning of buildings has some environmental benefits. Each of the building's sides is exposed directly to the wind, which is important in the induction of indoor air movement. Javanese buildings for *lurah* level usually consist of some single structures. The centre building (*dalem*) is, therefore, enclosed by additional buildings (such as *gandhok tengen* and *gandhok kiwa*). Thus, these adjacent buildings assume the role of horizontal wind barriers for the *dalem*.

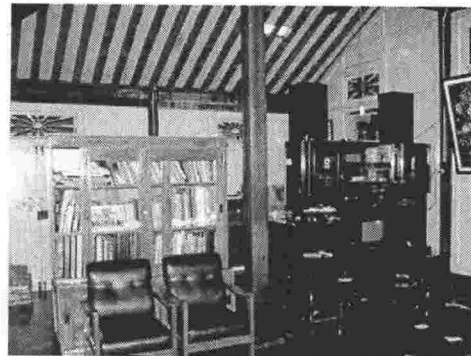

Figure 5-13 Difficulties in rearranging the room. Bookshelves have been used to create a new space division at *dalem*.

Two types of building development thus present themselves. In the past, any development from a basic configuration (containing a *dalem* only) to a more complex configuration (containing *gandhok kiwa*, *gandhok tengen*, etc.) appeared to take place carefully. The additional buildings were built within a sufficient distance, maintaining space between existing and additional buildings. Ventilation for all buildings was thus optimised (see Figure 5-14). In contrast, some present day owners do not appear as sensitive to these issues. To make wider indoor spaces, gaps have been



Figure 5-14 A gap between *dalem* and *gandhok*.

closed, and ventilation thus reduced (see Figure 5-15).

5.5.2 Orientation

The orientation of a Javanese building is dictated by its position relative to the Sultan's palace. The Sultan's palace complex faces north, although the main building faces east.¹⁹ This indicates a welcoming gesture to the Sultan's guests from the north.²⁰ A building located to the north of the

palace should face south. This reflects admiration from the building's owner to the Sultan. If a building is located to the south of the palace, it can face either north or south. Therefore, buildings are recommended to fall along a north-south axis.

Another theory describes south-orienting buildings as symbolic of the force of the Javanese belief in the spiritual connection to natural elements, such as mountains and water. This belief can be found throughout Southeast Asia. A study of traditional buildings in Yogyakarta Special Region by Dwiyanto concluded that southern orientation actually represents the Javanese eagerness to keep the macro and micro-cosmos in balance.²¹ By facing south, they link the mountain (to the north) and the water or sea (to the south). Of the ten case study Javanese buildings, eight are facing south. Those buildings are situated to the north of the palace. The two north-facing buildings are to the south of the palace. The location of the building, relative to the palace, thus seems to strongly influence its orientation.

Javanese buildings also face the street. As buildings should face either north or south, the street web must be adapted. However, Javanese buildings do not necessarily face the main street. Usually minor streets provide access from the main street to the front of a building.

Environmentally, orienting buildings to the north or south is highly recommended in tropical climate regions. This action reduces glare by avoiding the excessive penetration of direct sunlight and minimises the surface areas exposed to the morning and afternoon strong solar radiation. However, the width-length ratio (Javanese building plans tend to have a width-length ratio close to one) and the limited areas of wall openings (windows were originally unrecognised in Javanese architecture) seem to reject any attempt to relate the Javanese building orientation to thermal comfort.

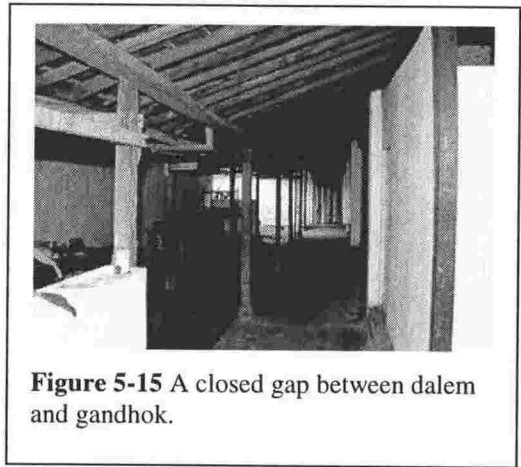

Figure 5-15 A closed gap between dalem and gandhok.

Another important consideration is the relation between Javanese building orientation and the dominant airflow direction. The south-oriented Javanese buildings could optimise the benefits of a dominant southwest wind direction. A study by Prijotomo of old Javanese literature revealed that a strictly north-south alignment is not recommended. Instead, the building should be slightly skewed to the west or to the east. This parallels the modern building science which suggests that buildings in hot humid climates should be slightly re-oriented around 5° from the south toward the east to minimise the over-heated period.²² The scientific rationale behind the recommendations of literature is unknown, except that it relates to supernatural considerations.

5.5.3 Roofs

The roof is an important part of Javanese architecture. It not only has practical purposes as a shelter but also represents the owner's status.

As mentioned, there are many roof styles in Javanese architecture. The choice depends on the social and financial status of the owner, and the purposes of the buildings.

The form has a dual role of function and aesthetic. The functional role answers the challenges of the Javanese environmental, including solar radiation, rain, and wind. Overhangs and steep slopes characterise Javanese roofs as similar to other roof forms in warm humid regions.

Despite the limited applications of some roof styles, residential buildings have many options to choose from. *Kampung*, *Limasan*, and *Joglo* groups are the most common choices for residential buildings. Although every style has a particular design order, there is always a chance for the builders to improvise and act creatively. Every roof is thus unique, even if based on a similar style. It is common to find various styles of roof in one residential building complex.

Joglo is the most unique. It was once used as the architectural symbol of Javanese architecture. It requires a lot of timber. Nowadays, when timber is expensive, *Joglo* is considered uneconomical, and only people with exceptional financial status can afford to build it. Some modern builders replace the timbers with reinforced concrete to reduce construction costs.

Javanese buildings commonly do not have ceilings. If they are used, it is for the purpose of reducing dust and other particles from the roof, as well as stopping leaking water during torrential rains. Dr. Arya Ronald queries this argument, believing that being surrounded by

dense trees, the intensely heavy rainfall should be reduced to such a level that would not pose such a problem as rain water leaks through the gaps between roof tiles. Obviously, this does not apply to a building with no tree barriers around it.

The ten case study Javanese buildings have *Joglo* and *Limasan* roofs of different styles. One building can have more than one style of roof. No two buildings have exactly the same roof configuration even though they can be grouped as either *Joglo* or *Limasan*.

The absence of ceilings has made it possible to apply skylighting. During the field observation it was found that a small number of glass tiles were used in most of the Javanese buildings. Between one and four glass tiles are inserted randomly among the clay tiles. This gesture is sufficient to bring sunlight into the house and create a unique ambient light. Dr Arya Ronald asserts that the *sacred* ambient light, created by direct sunlight, has a symbolic meaning. The filtered light dims objects in the room. It shows, symbolically, that the Javanese always welcome other people. They are friendly, and do not view others suspiciously. The dim light, penetrating the room through random glass tiles, creates a feeling of peacefulness. It acts psychologically, to make people feel restful and cool.

In terms of ventilation, *lambang gantung* is rather interesting (see Figure 5-17). This style detaches *guru* sector from *pananggap* sector, leaving a continuous gap. Sometimes this gap is closed with ornamented glasses, giving the impression that it is only for natural light. A study by Saragih of two Javanese buildings with and without *lambang gantung* revealed that the building with *lambang gantung* had a slightly lower indoor air temperature (0.2 ~ 0.7 °C) than the other.²³ Wider and higher gaps encourage higher airflow rates at high

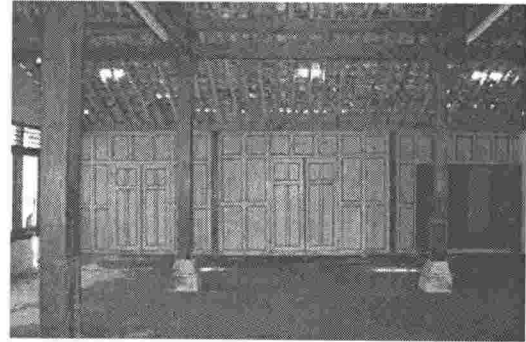

Figure 5-16 Glass tiles are common to give a bit of light. For a small space or room they are usually inserted randomly. But for a large room people tend to install them symmetrically.

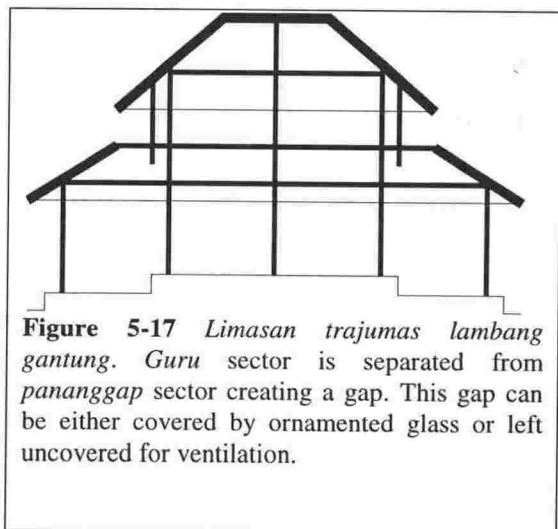

Figure 5-17 *Limasan trajumas lambang gantung*. *Guru* sector is separated from *pananggap* sector creating a gap. This gap can be either covered by ornamented glass or left uncovered for ventilation.

the hot air under the roof from accumulating. Meanwhile, air closer to the cooler floor can be kept stable. This has proved an important feature of Javanese roofs where the roof form plays an important role in ventilation.

Some features common to Javanese roofs (particularly *Joglo* and *Limasan*) include the following:

- The roof area is commonly divided into three sectors, namely *guru/brunjung*, *pananggap*, and *panitih* sectors, which relate to the centre, middle, and periphery parts (see Chapter Four). Visually, these three sectors can be characterised according to their degree of inclination. *Panitih* sector (the lowest part) has the shallowest inclination, whereas *guru* sector (the highest part) has the steepest. There is commonly an abrupt pitch change from *pananggap* to *guru* sector. The pitch change from *panitih* to *pananggap* is usually smooth.
- While the width, length and height of *guru* sector are strongly dictated by *petungan*, the width and length of *panitih* sector are not. Rather, they tend towards dimensional equality (a ratio of one).
- The long axis of the roof falls along an east-west axis. As a result wider areas of the roof face north and south.
- Overhangs are usually restricted to 50 centimetres depth.
- The elevation of the eaves is about three metres above the floor.
- Ceilings are not required, although the *guru* sector often has ceilings.
- Gutters are not required.

These features will be used as input values for the computer modellings.

As in other traditional buildings, Javanese roofs use natural materials. Common materials used for roof cladding include wood shingles and clay tiles. Rafters are made either from bamboo or timber, or a combination of the two. Bamboo can be used either split or in its natural form. Ceilings are mostly constructed of woven bamboo.

Clay tiles give roofs continuous ventilation. Traditional clay tiles were hand-made, and designed so that they do not fit tightly. There are always gaps between them, enabling air to ventilate continuously, night and day. This is, as Arya Ronald states, an important aspect of Javanese building ventilation. This might explain the lack of windows in Javanese buildings.

Combinations of clay tiles, bamboo, and timber were used in all ten case study buildings. None use wood shingles, which are mostly used on royal buildings. Not all materials survive, though, thus buildings need renovation and upgrades. Owners are acutely aware of the high cost of renovation. They have tended to substitute traditionally hand-made clay tiles with higher quality modern fabricated clay tiles. Fabricated tiles have the advantages of being

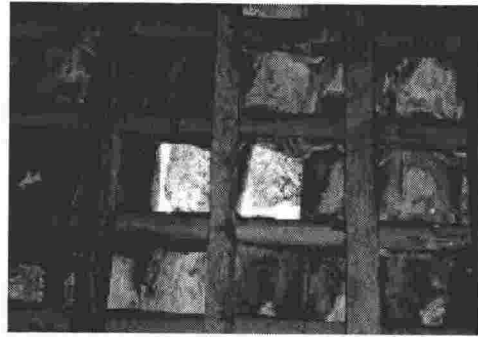

Figure 5-18 Common roof materials: clay tiles, bamboo, timber and randomly inserted glass tiles.

standardised, as well as having higher weather and mechanical impact resistance. A further case-study owner used corrugated steel to replace broken clay tiles; another replaced a woven bamboo ceiling with timber boards.

Spots of mould were found everywhere in the case study houses. This indicates both high indoor humidity, and inherently damp materials. Ignoring roof leaks seems to have advanced that material's decay.

The temperatures of the internal side of the clay tiles were relatively low, between 32 and 51°C (recorded on a relatively sunny day, with light breeze of 27°C). The low material conductivity, the overlapping arrangement (with air gaps) between tiles, mould layers, and free (continuous) airflow around every single tile are the likely cause of the relatively low clay tile temperatures.

5.5.4 Structures

Javanese building structures are unique, even if based on simple technology.²⁴ They are a combination of frame and load bearing wall structures. The main roof structure is always a frame structure, but the walls can be a combination of frame and bearing wall structures.

Javanese roofs are supported by a unique frame structure, called *tumpang sari* (see Figure 5-4). Unlike common simple modern roof structures, the Javanese roof structure is not constructed from closed-triangular frames. Triangular frames for roofs are unrecognised within Javanese architecture.

All main timber frame structures applied in the ten case study Javanese buildings are still in excellent condition, even though on average they are more than 80 years old. No signs of

structural deterioration were visible. By comparison, most brick walls had cracks and peeled plaster.

Using both frame and bearing wall structures in Javanese buildings unveils something of an ambiguity. The frame structure minimises internal obstructions, facilitating more free indoor air movement. On the other hand, the thick bearing walls tend to heavily enclose the building and block outdoor airflow.

The most common material for frame structures is timber. Wood from teak and Jackfruit trees is preferable. Teakwood is prominent, but more expensive than Jackfruit wood. According to Wiryatmaja, original Javanese architecture was exclusively teakwood.²⁵ While there is no question of the quality of teakwood as a building material, this reflects the limited technology of Javanese architecture. Study of Javanese structures by Ronald leads to the conclusion that Javanese builders had a limited knowledge of building materials beyond their aesthetics (which were superb).²⁶ Although knowledge of alternative materials might be sparse, builders' knowledge of teakwood was based on long experience with it as a building material.

Eight of the ten case study buildings used timber from Jackfruit trees. This material costs less than teakwood, but is still reliable. The fine fibres of Jackfruit wood give a shiny finish. Although of higher quality, some people argue that teakwood's popularity also comes from its extensive use by high-ranking people.

5.5.5 Walls

In Javanese architecture, walls are not assigned the same complicated meanings as roofs. They represent the same ideas of architecture in warm humid regions, suggesting walls to be less important than roofs. All of the books on Javanese architecture used in this research (those written by Prijotomo, Arismunandar, Dakung, and Hamzuri) provide very limited information about walls. Many do not discuss walls at all. According to Arya Ronald, this reflects the authors' opinions, preferring a classification of architecture according to distinctive roof forms.

The limited study of walls is related to the simplicity of plans. As previously discussed, Javanese buildings have simple plans; most of them are single room buildings with simple partitions.

External walls in Javanese architecture are not complicated. They represent the simple square or rectangular plan of buildings. As Javanese buildings rely more on more frame

structures, most walls are not load bearing; They are limited to screening purposes. The introduction of brick by Dutch builders contributed to the use of thick brick walls in Javanese buildings. These walls, around 250 millimetres thick, used pillars for reinforcement. Despite simplicity in plan, some Javanese walls have complicated ornaments, each conveying a deep spiritual meaning.

Openings are surprisingly small. Contrary to the recommendation of most references for buildings in warm humid regions, the openings in Javanese building are minimal. According to Arya Ronald, windows serve the purpose of connecting micro cosmos to macro cosmos, rather than for ventilation purposes. This function is served by the gaps between roof tiles. Doors are set centrally in the front of the house. If windows are added, they are usually set symmetrically at both sides of the door. Smaller doors and windows are placed on sidewalls. Some experts believe windows to be a product of Portuguese colonisation, rather than being of Javanese origin. An absence of windows in early Javanese architecture is believed to reflect the predominantly outdoor lifestyle, characterised by rice fields, the yard, etc.)

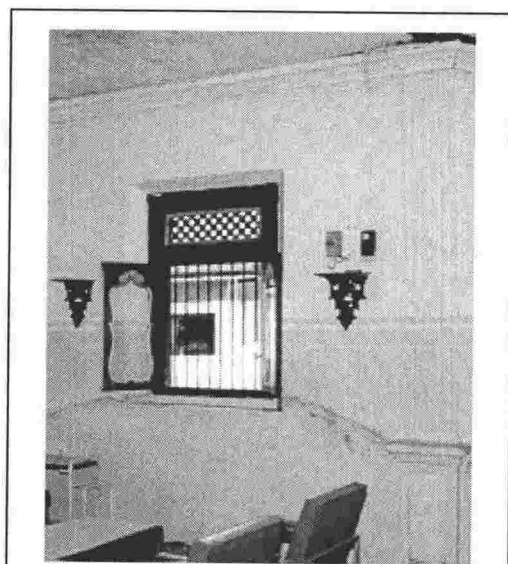

Figure 5-19 Common style of windows on thick walls with steel bars.

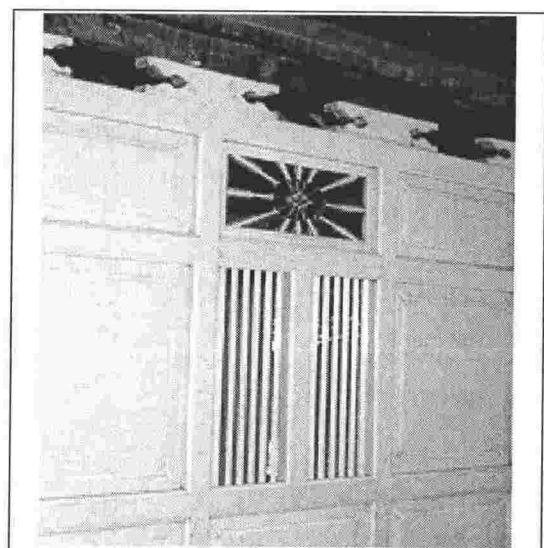

Figure 5-20 Common style of windows on timber plank walls with bars.

Field observations revealed that windows are not always opened. Some have not been opened for a long time. Already small windows are further restricted by application of bars for security. There were indications that some owners were aware of the small size of their windows, and had attempted to enlarge them. However, they could not specify whether this action enhanced indoor lighting quality, ventilation quality, or otherwise. The wider openings, then, were kept closed. Many openings were blocked by furniture (cupboards, partitions, etc.).

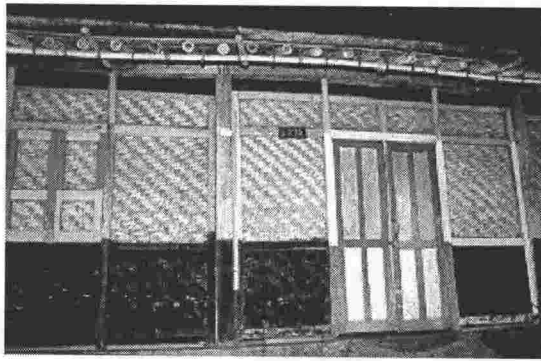

Figure 5-21 Typical openings in rural bamboo houses.

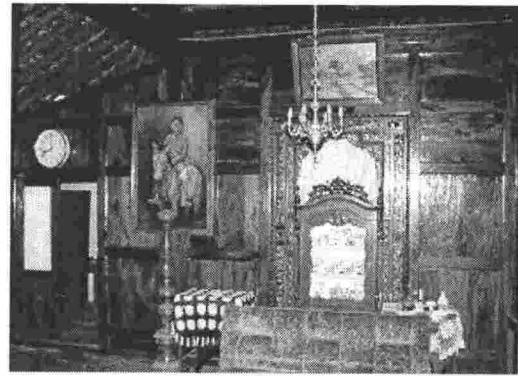

Figure 5-22 Ornamented walls.

There are thus two features in Javanese external walls contradictory to common wall designs for hot humid climate regions: thick walls and small openings. Combining thick walls and small openings is believed characteristic of hot dry climate architectures, and in hot humid climate regions is assumed to result in an unbearable indoor atmospheric condition. However, the wide use of this pairing, combined with a lack of complaints from occupants (regarding thermal discomfort), might call this belief into question. These features may be equally applicable to hot humid climate regions.

References such as Koenigsberger's book²⁷, indicate the thermal effect of the *thick walls-small openings* combination to be based on structural thermal lag phenomenon. In hot dry climate regions, the structural thermal lag keeps indoor air cooler during the hot days and warmer during the cool nights. Experts say that in hot humid climate regions the night and day air temperature differential is too small for this to be effective. Moreover, high humidity demands air movement, which is not discouraged by the *thick walls-small openings* combination.

The key difference between the *thick walls-small openings* relationship in hot dry climate architectures and of Javanese architecture is in the roof. The former use simple flat roofs whereas the latter use more sophisticated roofs (in this case *Joglo* and *Limasan*).

Assuming that Javanese buildings which apply a *thick walls-small openings* combination are thermally comfortable, some arguments can be offered:

- In Javanese architecture, walls have a negligible effect on indoor thermal comfort. Roofs are the dominant factor. This seems to correlate with the assessment that ventilation in Javanese building is through the roof. The small openings in thick walls reflect security considerations.
- The *thick walls-small openings* combination and light roofs generate a form like an opened container. All air movement occurs at the upper part (the porous roof). Thus, warmer air

(rising by the stack effect) ventilates through gaps in the roof. The lower part, having no windows, preserves cooler air from the previous night.

- The *thick walls-small openings* combination does play an important role in creating thermally comfortable indoor atmosphere. It keeps the indoor air temperature relatively constant. This argument appears to hold if the roofs have, at least, the same thermal behaviour as the walls, which is not the case in Javanese buildings.
- The *thick walls-small openings* combination and the roof create a certain indoor atmosphere condition which is considered thermally comfortable for the Javanese, even though its parameter values do not match current thermal comfort standards. This scenario, in its development, might produce a new theory on thermal comfort. It could be that indigenous Javanese architects, deliberately or not, use relative thermal sensations of the skin to induce a cooling sensation in the body. On a bright, hot, sunny day, someone would experience a cooling sensation if he/she moves from outside into a humid, dimly lit room. Indoor air temperature is increased by the radiation of human body heat. However, as Javanese buildings have large air volumes, the air temperature increase is minimal. Additionally, thermo-hygrograph readings taken inside Javanese buildings show that air temperature and humidity (see example of thermo-hygrograph inside building in Chapter Three.) are outside current standard thermal comfort zones, but personal onsite interviews found that the occupants do not feel uncomfortable. Further research needs to be done to develop a deeper understanding of this issue, differentiation between comfort and tolerance. (See 2.6.3 for thermal comfort standards used in this experiment.)
- The *thick walls-small openings* combination actually reflects a hybrid form of buildings.²⁸ A hybrid building accommodates seasonal or daily thermal changes by combining lightweight and heavyweight construction to create warmer or cooler indoor air. This argument makes sense. Usually, Javanese buildings contain at least two buildings: *dalem* (enclosed, heavyweight) and *pendapa* (opened, lightweight). A kind of *local migration* (working or sleeping in *pendapa* when it is hot or in *dalem* when it is cool) is a common practice. A wide bed (*amben*) is commonly placed in the *pendapa* to relax or nap during hot days. It remains common practice for a small group of men to talk until late at night at *pendapa* and sleep there even without any mattresses (usually using reed mats only).

The absence of large openings in Javanese buildings might also reflect the people's perception of the wind as a negative force. A chest cold, for example, is named *masuk angin* (meaning an ill, caused by air intrusion to the body; *masuk/kemasukan* = intruded, *angin* = wind). Chinese belief (Feng Shui) similarly considers wind an evil spirit. It is common, even today, to avoid excessive wind.

The positions of openings are usually symmetrical. Javanese buildings consist mostly of symmetrical individual buildings. Openings are located in a geometrically ordered way (such as centrally in walls) and employ mirror symmetry (usually an opening in the left is mirrored by one in the right; windows are placed both sides of a door). Such a configuration of openings encourages cross-ventilation which is highly recommended for warm humid climate.

The most common materials used in Javanese walls are brick, timber plank, and woven bamboo. Some buildings use a combination of them. Bricks and timber planks are preferred, as woven bamboo is mainly used by poor people.

The external walls of the ten case study buildings were still in a reasonable condition. Some had been renovated. Intense growths of mould had formed, on both brick walls and timber walls.

The different properties of the wall materials (brick, timber plank, and woven bamboo) have individual pros and cons in relation to indoor thermal comfort. Since Javanese buildings only have short overhangs, walls are more exposed to rain (which can be very intense in hot humid climate regions) and direct solar radiation. Planting trees around the building seems to reduce this problem.

Brick walls are thick and whitewashed, which helps reduce indoor solar heat gain. The approximately 250 millimetres thick walls have a large thermal time lag, around seven hours. Moreover, the whitewashed walls reflect solar radiation up to 80% when newly applied.²⁹ Even woven bamboo walls are sometime whitewashed, using gypsum. This factor, combined with dense foliage, screen direct solar radiation, thus keeping a wall cool.

Unlike brick walls, which are mainly whitewashed, timber walls are usually kept either in their original colour, varnished, or colour painted. A study by Sarwadi on the change of colour in Jeron Beteng housing (houses inside the Sultan Palace walls) found a relationship between people's cultural attitudes and their propensity to change their house colour.³⁰ Families who

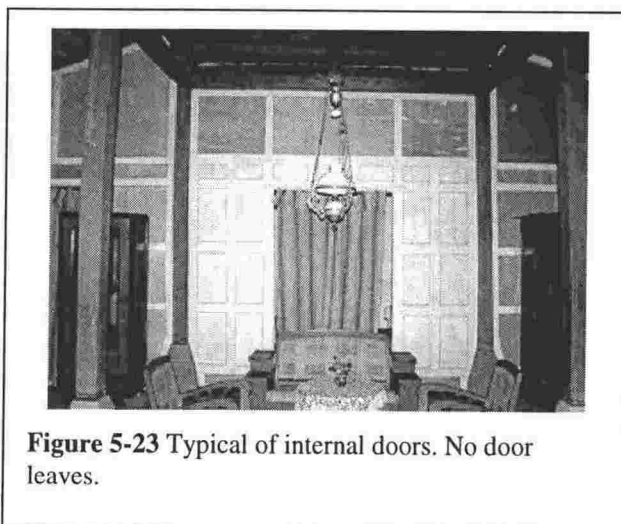

Figure 5-23 Typical of internal doors. No door leaves.

maintain the Javanese language as their first language tend to keep their houses in the original colour. Conversely, families who do not use Javanese language have tended to change the colour. Preference of whitewashed brick walls may have a philosophical or psychological meaning (perhaps relating to purity and cleanliness). In terms of building science, however, the white washed brick walls help, by reflection, to reduce the solar heat gain.

Damp wall surfaces encourage mould growth. Such surfaces are caused by either capillary mechanisms (water flows up from the damp ground, or rain water moving from external surfaces to internal surfaces) or indoor air condensation. These moist walls, as found in some Javanese buildings, enhanced the cool sensation of the room.

Woven bamboo is still widely used in villages even if less popular for new buildings. Demands for security, status, durability, and fire safety are some reasons that make woven bamboo less popular and hasten its replacement by such materials as bricks and timber.

Table 5-1 lists some materials commonly used in Javanese buildings. There is no comprehensive list of materials' properties (as found in Javanese buildings) currently available. This data has been collected and interpolated from various sources. It should be noted that data sourced from literature is predominantly based on laboratory measurement, and might not be identical to traditional Javanese building materials. The difference is assumed negligible. This data will be used as material property inputs in the computer experiments.

Table 5-1 Material Properties

Materials	Density (kg/m ³)	Heat capacity (J/kg °K)	Conductivity (W/m °K)	time lag hour
Brick	1600	994.4	0.41 ~ 0.70	7.5 h/23cm
teak wood (<i>Tectona grandis</i> L.f.) perpendicular to grain parallel to grain	670	1871.9.82	0.07 0.12~ 0.17	1.5 h/2.5cm
Clay tiles	2645	960	0.775	
jack fruit wood (<i>Artrocarpus heterophyllus</i>)	630	2853.1	0.07	
bamboo apus (<i>Gigantochloa apus</i> Kurz.)	600			

Javanese buildings have no complicated internal walls. Internal walls are usually not complicated and are only used for partitioning. Less internal walls mean less internal air obstructions. Internal walls in Javanese building are used to define *dalem*, *senhong tengen*, *senhong tengah*, and *senhong kiwa*. Internal walls mostly use timber planks or brick. Woven bamboo is used by the poor.

Despite spots of mould, most internal walls were in good condition. Timber planks were applied either in their natural textured condition, or were varnished or painted. The natural colour of the timber is dark brown. Mould mostly grew on untreated planks.

Timber planks provide less wind obstruction than brick walls. Unlike walls which are built up to the ceiling, timber planks usually leave gaps of about ten centimetres.

5.5.6 Floors

Javanese buildings are not built on stilts, but their floors are raised. Evidence indicates that ancient Javanese built their houses on stilts high enough to make the space under the floor functional. Prasodjo's study of temple relics in Java revealed the development of Javanese floors from stilted to ground-based forms.³¹ He concluded that the stilted method was widely used by ancient Javanese, while, the grounded method had been imported from India through religious building. A relic found in Borobudur temple indicates that original Javanese buildings were built on stilts.³² However, Parmentier stated that the Borobudur artists might not be local, that they recalled the house styles of their previous settlements.³³

Floors usually have simple designs. The aesthetics of Javanese floors are found in their ornamental designs, which are usually appropriate to royalty. For a person of *lurah* socio-economic level, floor design should not be too decorative.

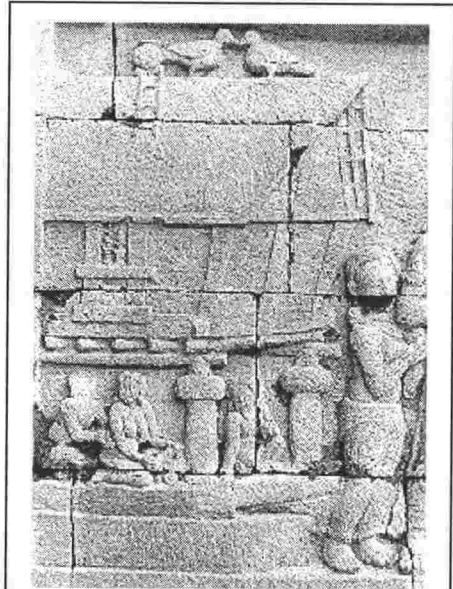

Figure 5-24 Elevated floor systems found in Borobudur temple, central Java, 9 AD. Note that the space under the floor is functional. According to Parmentier, this style is probably an imported style rather than local style.

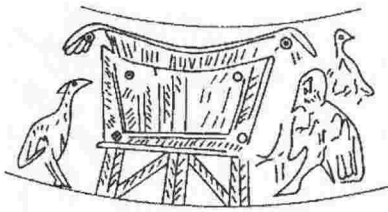

Figure 5-25 The Indonesian style house found on the Ongbah cave cylinder. It is thought to represent most of Indonesian traditional architecture.³⁴



Figure 5-26 A house in Pakem that applies elevated floor system by raising the ground level. Thus, unlike other traditional styles in Indonesia, Javanese buildings do not utilize the space under the floor.



Figure 5-27 A Malay house with an on-stilts system.³⁵



Figure 5-28 A Sundanese house, west Java, applies an on-stilts floor system.³⁶



Figure 5-29 An effort to update *dalem*. The floor has been modernized using shiny ceramic tiles. At the background, a new style double bed which recalls the past days.

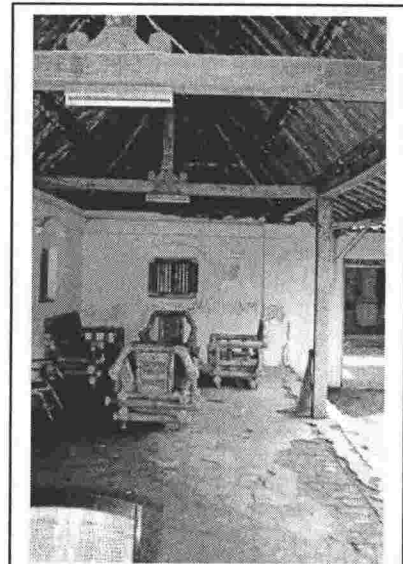

Figure 5-30 Common conditions of floors.

There was nothing special about the case study floor designs. All ten buildings had flat simple designs with no ornament at all. Simple cement surfacing was used. The minimum floor height was 600 millimetres.

Elevated floor systems are common in warm humid climate regions; vernacular architecture in such areas is commonly on stilts. In Indonesia, many vernacular buildings were also raised. The cause of this practice is found in such factors as flooding, wild animals, and war. The stilted system is also believed by experts to be a deliberate gesture to catch more air movement.³⁷

The contribution of the on-stilts system to indoor ventilation improvement has been proved by experts such as Yeang and Yuan³⁸ in studies of Malay architecture. Elevated floors have openings exposed to more wind stream which then cools the house through additional ventilation through the floor's gaps.

Javanese floors are elevated using a fill-in method (elevated ground). There is no air path under the floors. During the field study, there was no obvious benefit of an elevated floor system in catching more wind.

Brick, cement and marble are popular materials for floors. However, the choice still

depends on the owner's status. It is common for most poor buildings (usually in the villages) to have bare soil floors (loose packed earth floors).

As the ten case study Javanese buildings are for *lurah* level, they do not have luxurious floors. Most of them are in a bad condition: stained, peeling, and damp. Some occupants cover their floors with carpets.

During the field study it was found that floors in Pakem areas tend to be wet. This may have two causes: rainwater penetration from the higher-level water-saturated ground surrounding the buildings, or indoor air saturation (although humidity records showed RH did not reach 100% and is therefore unlikely). While the floors of all ten case study buildings were in a poor condition, mostly due to dampness, this sometimes enhances the sense of a cool and humid indoor atmosphere.

Floors are relatively cooler than surroundings surfaces. Sitting or lying on floors is a common practice for hot days. Thermal conduction from the body to the cool floor helps relieve body heat stresses. Bare feet is also believed to give the same sensation.

5.6 Furnishing

Furnishings have changed with lifestyles. In the past, standard Javanese buildings were equipped with very basic furniture, including a large bed, dinner table set, and cupboard. Other furniture was kept in separate buildings. The field study found signs of transition from past to modern lifestyles. All ten case study buildings still had the old style furniture. However, the arrangements have changed due to the introduction of such modern equipment as televisions, freezers, stereos, and fans. Sofas are also considered new furniture. Basically, furniture styles are the same. Modern furniture, however, offers broader stylistic and material selections. Also, electricity and electronics has contributed to a wider variety of household furniture permutations.

The field study found all ten buildings' furnishings to be either in their nearly original states or, if at all, only slightly adjusted to new conditions. The two most obvious changes were: the presence of modern equipment (electric and electronic apparatus) and modern furniture styles (wide sofas, beds, etc.). All ten buildings still utilise traditional furniture (cupboards, chairs, tables, and beds).

The introduction of some new furniture and equipment had resulted in interior layout problems. New furniture and equipment (such as the television) cannot be easily integrated into

the building design (such as an open layout). This can result in an inefficient use of natural ventilation by obstructing air movement.

5.7 Summary

- In relation to thermal comfort, Javanese architecture seems to take a different approach (based more on spiritual or supernatural considerations) than western architecture (based more on physical or material considerations); however, most Javanese design features can be explained using modern science. External and internal aspects of residential Javanese designs, from landscape to interior design, have been prepared to create a comfortable space to live.
- Javanese buildings were originally designed to stand solitary on a wide site, surrounded by plants. This becomes difficult for urban locations, where physical developments (roads, buildings, etc.) replace the natural landscape.
- Orientation of Javanese buildings can be either to the north or south, depending on their relative position to the palace, and skewed slightly to the west or east.
- *Dalem* is the basic configuration of Javanese buildings, where family members spend their indoor life.
- Roofs are unique and are given the most attention. The roof form indicates the style of the building. The roof material, traditional hand-made clay tiles, is an important feature of the Javanese roof. It provides for continuous ventilation through its gaps. Overhangs are not very wide, being about 50 centimetres
- Walls are made from either timber or thick bricks, with small openings.
- Floors are elevated (without space underneath).
- Furnishings are mostly simple (wide beds, chairs and table). Inexpensive televisions and stereos are the only prominent modern equipment found in the field.

The following chapter (Chapter Six) discusses theoretical approaches to the interrelationship between Javanese residential building designs and indoor thermal comfort.

Endnotes

¹ Prijotomo, J., 1995, Petungan: sistem Ukuran dalam Arsitektur Jawa, Yogyakarta: Gadjah Mada University Press.

² Wiryatmaja, S., 1986, Pengetahuan Bangunan Rumah Tradisional Jawa (Pengetahuan Kalang), Departemen Pendidikan dan Kebudayaan - Direktorat Jendral Kebudayaan, Proyek Penelitian dan Pengkajian Kebudayaan Nusantara (Javanologi).

³ Explanation, clarification and input on Javanese architecture have been given by Arya Ronald , Joseph Prijotomo (e-mails) and Hamzuri (inter-local)

⁴ Hamzuri, 1982, Rumah Tradisional Jawa, Jakarta: Departemen Pendidikan dan Kebudayaan, p.81.

⁵ Emiliana, Salamun, Taryati, Isyanti, 1992, Kesadaran Budaya tentang Ruang pada Masyarakat di Daerah Istimewa Yogyakarta (Studi Banding mengenai Proses Adaptasi, Departemen Pendidikan dan Kebudayaan, p.43.

⁶ Nowadays, the Indonesian government is still using the term *lurah* for a community leader with a limited authority although the jobs are different.

⁷ Ronald, A., Santoso, M., Saragih, S., 1987, Joglo Buildings - A Study of Construction, Proportion and Structure of Royal Houses in Yogyakarta, Yogyakarta: Department of Architecture, Engineering Faculty, Gajah Mada University, p.50.

⁸ Wiryatmaja, op. cit., p.34.

⁹ Photo taken from Dawson, B. and Gillow, J., 1994, The Traditional Architecture of Indonesia, London: Thames and Hudson, p.90.

¹⁰ Robinette, op.cit., p.54.

¹¹ It was a remarkable experience that during the field survey to the Javanese buildings the owners were available to talk to. Most of the occupants are old people and still have good memories of the past as most spent their childhood in the same building and environment. Some of them even remembered the past as a golden era. This might reflect their dignity as a *lurah* family.

¹² Ibid., p.53.

¹³ Mangunwijaya, Y.B., 1980, Pasal-Pasal Penghantar Fisika Bangunan, Jakarta: PT Gramedia, p.108.

¹⁴ Robinette, G.O., 1983, Landscape Planning for Energy Conservation, New York: Van Nostrand Reinhold Company, p. 12.

¹⁵ Mangunwijaya, Y.B., 1980, Pasal-Pasal Penghantar Fisika Bangunan, Jakarta: PT Gramedia, p.108.

¹⁶ Interview.

¹⁷ Dakung, S., 1981, Arsitektur Tradisional Daerah Istimewa Yogyakarta, Yogyakarta: Departemen Pendidikan dan Kebudayaan, p.25.

¹⁸ Emiliana, et al., op. cit., pp.51-52.

¹⁹ Hamzuri, op. cit., p.140.

²⁰ Yogyakarta is located in the southern part of Java. With no countries to the south of Java, and the danger posed by landing on those southern beaches, most visitors were expected to come from the north.

²¹ Dwiyanto, D., 1989, Makna Religius Tata Letak Rumah Tradisional Jawa dan Bali, unpublished research report, Faculty of Literature, Gajah Mada University, pp.24-25.

²² Olgyay, V. And Olgyay, A., 1969, Design with Climate, Bioclimatic Approach to Architectural Regionalism, Princeton, New Jersey: Princeton University Press, p.61.

²³ Saragih, S., 1990, Unsur Bukaan dalam Sistem Ventilasi Atap Bangunan Peninggalan Jawa di Yogyakarta (Studi Kasus: Bangunan dengan Atap Lambang Gantung), unpublished research report, Department of Architecture, Faculty of Engineering, Gajah Mada University.

-
- ²⁴ Wiryatmaja, op cit., p.12.
- ²⁵ Ibid.
- ²⁶ Ibid., p.38.
- ²⁷ Koenigsberger, O., Ingersol, T.G., Mayhew, A., and Szokolay, S.V., 1973, Manual of Tropical Housing and Buildings, Part 1: Climatic Design, Bombay: Orient Longman.
- ²⁸ Szokolay S.V., Cooling Problems and Responses in Predominantly Overheated Humid Regions. In Bowen A., Clark E., and Labs K. ed., 1981, *Passive Cooling*, International Passive and Hybrid Cooling Conference, Miami Beach 1981, the Publication Office of the American Section of the International Solar Energy Society, p.655.
- ²⁹ Mangunwijaya, op cit., pp.116-128.
- ³⁰ Sarwadi, A., 1993, Perubahan Warna yang terjadi pada Rumah Tinggal di Jeron Beteng Keraton Sultan Hamengku Buwana – Kotamadya Yogyakarta, unpublished research report, Department of Architecture, Faculty of Engineering, Gajah Mada University.
- ³¹ Prasodjo, T., 1988, Relief Rumah pada Candi di Jawa, Sebuah Gambaran Rumah Jawa pada abad IX - XVI Masehi, unpublished research report, Faculty of Literature, Gajah Mada University.
- ³² Dawson, B. and Gillow, J., 1994, The Traditional Architecture of Indonesia, London: Thames and Hudson, pp.81-82.
- ³³ Parmentier, M.H., 1907, L'architecture Interprétée dans les Bas-Reliefs Anciens de Java, Bulletin de l'Ecole Franchise d'Extreme-Orient, vol.VII-1907, p.1-60.
- ³⁴ Sørensen, P., 1982, A Brief Survey of East and Southeast Asian Prehistoric Houses, in K. G. Izikowitz & P. Sørensen (eds.), *The House in East and Southeast Asia: Anthropological and Architectural Aspects*, London: Curzon Press Ltd. (This picture has been downloaded from <http://www.mediaport.org/~ser/arche/>)
- ³⁵ This photo was taken from Yeang, K., 1992, The Architecture of Malaysia, Amsterdam: The Pepin Press, p.109.
- ³⁶ Schopert, P., Damais, S., Sosrowardoyo, T., 1997, Java Style, Singapore: Editions Didier Millet.
- ³⁷ See in depth study on elevated floor systems in Satwiko, P., 1992, The Contribution of Elevated Floor Systems to the Environmental Performance of Houses in Warm Humid Regions, unpublished research report, School of Architecture, Victoria University of Wellington.
- ³⁸ Yuan, L.J., 1987, The Malay House, Rediscovering Malaysia's Indigenous Shelter System, Pulau Pinang, Malaysia: Institut Masyarakat.

Handwritten text in a script, likely Tamil, appearing on the left side of the page. The text is partially obscured by a dark vertical band.

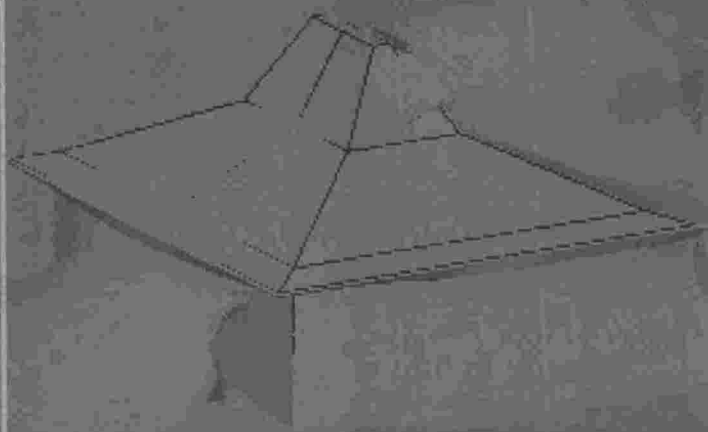

Handwritten text in a script, likely Tamil, appearing on the left side of the page. The text is partially obscured by a dark vertical band.



6. JAVANESE RESIDENTIAL BUILDINGS AND INDOOR THERMAL COMFORT

6.1 Introduction

This chapter discusses the scientific facets of thermal comfort features in Javanese architecture. Those scientific explanations are useful in the translation of the Javanese buildings into computer models, particularly in focusing experiments onto the relevant factors of Javanese building thermal comfort performances. Beginning with a review of tropical building design conventions, as compared to Javanese designs, the chapter continues by theoretically surveying the aerodynamics and thermal performance of Javanese buildings. Indoor thermal comfort and occupants' zones are expanded before a summary list of information that can be used in experiments.

Comparing current theories and rules-of-thumb, this first sub-chapter investigates guidelines intended to shape the design of tropical buildings, to achieve indoor thermal comfort. As most references are based on western theoretical material, this section thus intends to extract western scientific approaches applicable to thermally comfortable tropical building design. This thus collates a structured list of *western* scientific guidelines for tropical building design to achieve indoor thermal comfort.

Only a limited number of environmental books have been written that deal specifically with design for tropical buildings. Even amongst those, no single book thoroughly discusses hot humid tropical building.¹ Texts that do contain such material, relating to warm humid tropical building vis-à-vis thermal comfort are those written by Koenigsberger², Lippsmeier³, Kukreja⁴, and the Drews⁵. Such Indonesian authors as Mangunwijaya⁶ provide useful basic guidelines. However, a certain reliance on graphics leaves these texts devoid of the analytical tools which might be useful for users to confidently design for their own thermal comfort. Also the books written by Lim⁷ and Koenigsberger⁸ provide indirect guidelines for thermal comfort in a warm humid climate. These books also advise on construction and materials.

With only a small number of books pertaining to warm humid climate building science, more general writing should be consulted. Boutet⁹ and Awbi¹⁰ discuss ventilation in detail. Aynsley's text reinforces this discourse, reviewing aerodynamic issues¹¹. Though Awbi includes

a detailed discussion of thermal comfort, text by Olgyay¹² and Fanger¹³ remain important as references, given that current thermal comfort standards are influenced by their ideas.

6.2 Hot Humid Tropical Building Designs

Achieving indoor passive thermal comfort in a hot humid climates is one of the most challenging building design considerations. The following three tables consolidate the guidelines to be found in currently available references. The first (Table 6-1) compares general features of hot humid climates to specific features of the Yogyakarta Special Region (which is also discussed in Chapter Three). The second (Table 6-2) summarises building guidelines in general; the third (Table 6-3) covers specific guidelines for roofs, walls, and floors. The latter two tables are intended to reveal the similarities or discrepancies between the guidelines provided and the facts researched from Yogyakarta Special Region. Material on Yogyakarta Special Region is based on visual observation and field documentation of the ten case study buildings.

In general, the features of the Yogyakarta Special Region match with the general features of hot humid climate regions (see Table 6-1). However, there are some specific local conditions, both physical (eg. local weather) and non-physical (eg. local socio-economy). Understanding these local variations is thus useful to avoid biased evaluation of Javanese building designs, which can occur if the general features are applied blindly as a reference for the experiment. The thermal comfort related factors (air temperature, air velocity, and humidity) presented in Table 6-1, and discussed in detail in Chapter Three, are thus more suitable to be used in the experiment, as they more precisely represent conditions in the Yogyakarta Special Region.

The local Javanese conditions, as shown by Table 6-1, influence building designs. The following assumption lists the relation of local variations to Javanese building designs, which are useful for the experiments (in particular, in the flow domain and boundary condition definition):

- Since Javanese buildings are in the southern hemisphere of an equatorial region (relatively distant from the equator), facing them south means less glare (as the sun is in the north side longer than in the south side of the buildings).
- Since wind blows from 180 to 240° clockwise from the north, facing Javanese buildings within that range will optimise the ventilation effect.
- The hot afternoon is the hardest time to work. Observations found that during this time a short rest is needed. Javanese buildings should be able to accommodate that demand by converting the harsh outdoor environment to a pleasant indoor atmosphere. They should remain thermally comfortable during the hot afternoon. In technical terms, the indoor

condition should be within the comfort zone of the thermal comfort standards. However, the comfort sensation is not totally reliant on the building designs. Low clothing values of the occupants improve that sensation.

- The landscape, ground condition, and vegetation around Javanese buildings determines the wind profile. For buildings in the rural areas, the original environment, the landscape is within terrain category 2. For those in the urban side, the landscape is within category 3. This terrain category affects the air velocity (averagely 3.53m/s measured 10m above the ground) when it sweeps Javanese buildings.

In a comparison between modern building design guidelines and the environment of Javanese buildings, Table 6-2 reveals no conflict. Most of the modern building design recommendations have been applied in Javanese building, and have been adjusted to local conditions. Some aspects of modern building design are not recognised in Javanese building designs, such as the use of comfort standards. The ventilation system is different, as Javanese buildings rely on roof ventilation. The most important difference is that Javanese building designs always involve spiritual considerations. The following information from Table 6-2 relates to aerodynamics and the thermal performance of the buildings, and is useful in constructing realistic computer models:

- Spiritual values, in particular *petungan*, are important aspects of Javanese building designs. *Petungan* is applied according to the function of the building. For *dalem* (residential buildings, usually either *Joglo* or *Limasan* style) the *petungan* value is *sri*; this affects the dimension of the buildings and thus their aerodynamics performance.
- Vegetation (canopy-like trees) is also useful to minimise walls (and roofs) heat gain by blocking early morning and late afternoon strong solar radiation. Roofs can be considered the only surfaces gaining heat from the sun.
- According to the traditional rules, Javanese buildings can be oriented either north or south, with a slight skew either west or south. Though information derived from Table 6-1 shows the advantages of orienting the buildings south (slightly skewed to the west), facing to the Sultan's Palace has the highest priority. Orienting the building south, and slightly skewed to the east, will match the modern building science recommendation to minimise afternoon glare, but reduce the benefit of wind effect on ventilation.
- The scattered configuration of Javanese buildings has made it possible for all their exterior surfaces to be exposed to wind flow. It also reduces the effect of wind shadow between buildings.
- The modern building science recommendation of minimum interior layout reaches its extreme in Javanese buildings; most of them are single room buildings or have very simple

partitions.

- Javanese buildings have a specifically applied roof ventilation system; wall openings are not so important.

Focusing on the form and material of the roofs, walls and floors, some information from Table 6-3 can be listed as follows:

- Spiritual values (*petungan*) are strictly applied to the *guru* sector of the roof.
- Roofs' forms are based on the five basic styles.
- Natural materials with good heat insulation are used for roofs, walls and floors.
- Ventilated roof effect is achieved by applying porous materials.
- Walls do not necessarily have openings.
- Interior walls are minimal.
- Elevated floors without functional space underneath.

Table 6-1 General features of hot humid climate and the Yogyakarta Special Region.

Topic ¹⁴	General features as found in references	Observations in Yogyakarta Special Region	Comments (in relation to Javanese buildings)
Position	Equatorial, 15°N to 15°S	7°33" -8°15" S. The Yogyakarta Special Region is in southern hemisphere of equatorial region.	Javanese buildings are within the equatorial region; the sun radiation is almost the same throughout the year. Twice a year, the sun is right above the buildings; for a clear day it has the highest radiation intensity. Since they are in the southern hemisphere, annually, the sun is in the north of the building slightly longer than in the south. Theoretically, facing the building south is slightly better to avoid glare.
Life	Often takes place out of doors during the day and evening ¹⁵ , afternoon rest (nap).	Mixed between indoor and outdoor, depending on the activities during the day and evening, afternoon cooling down (nap, relax) is likely. In town: government office hours 07:30-14:15 (6 days a week), private office hours 8:30-17:00 (6 days a week), shops hours 8:30-21:30 (7 days a week); 24 hours food stalls (7 days a week); school hours 07:00-13:00 (6 days a week). Government office and school times enable people to rest during the hot afternoon when working is unproductive (caused by tiredness). Evening is mostly for informal activities (sports, recreation, socialising, window-shopping, etc.); outdoor or semi-outdoor (in the terrace) are most likely. In villages: flexible timing for farmers. Usually, farmers work in the rice field from morning to dusk (depending on the rice cycle), with a break around lunchtime. Evening is for	Life in Yogyakarta reflects life in hot humid climate. People are mostly out of home during the day. Take a short rest (or nap) is likely during the hot afternoon. Thus, there is a need for the building to be thermally comfortable during the hot afternoon.

Customs	Social customs allow large areas of bare skin to be exposed ¹⁶ , light clothing.	socialising or stay at home.	Light clothing matches with clothing for hot humid climate in general. Clothing values are low, 0.1 – 0.4.
Landscape	Rainforest along coasts and in equator lowland.	Urban: very high building density of business and <i>kampung</i> (compound) areas; mixed between old (Dutch-colonial, Chinese and Javanese styles) and new (universal style) buildings; Rural: rice fields dominate the rural landscape, interrupted by parks, conservatory, sugar cane fields, and trees. Palm trees along coasts.	No rainforests in Yogyakarta. The rural landscapes of trees and rice fields are the most common condition around Javanese buildings. Thus, Javanese buildings in the city will have terrain category 3, while those in the countryside have terrain category 2.
Ground conditions	Green landscape, red or brown ground, moist ground, high ground water level at times reaching the surface. Morning mist over low ground	Green landscape, brown and moist ground, gypsum in some parts, low (more than 20 m) to high (less than 3 m) ground water table.	Ground condition matches with general hot humid climate regions.
Seasons	No extreme season difference throughout the year, for southern hemisphere coolest months: April-July and warmest months: October-February with highest precipitation.	No extreme seasonal difference throughout the year. Coolest month: July-August, warmest month: October-November with highest precipitation in March.	The season in Yogyakarta Special Region matches with other hot humid climate regions, in terms that it is not extreme.
Vegetation	Luxuriant, superabundant, multifarious throughout year, mould, fungus, many good timbers (teak, etc.)	Various kinds of vegetation throughout the year, mould, fungus, many good timbers (teak, jack fruit, palm tree, etc.) Canopy like trees and shrubs are commonly surrounding Javanese buildings.	Vegetation is similar to other hot humid climate regions.

Sky conditions	Cloudy (60-90% coverings) ¹⁷ and hazy, continuously changing cloud types, twilight is 18 minutes before sunrise and after sunset.	Sunny (either clear or hazy) and cloudy intermittent, continuously changing cloud types, twilight is 18 minutes before sunrise and after sunset.	Sky conditions are similar to other hot climate regions.
Solar and heat radiation	Moderate to high direct solar radiation, moderate reflection of solar radiation from clouds, little reflection of solar from ground, little heat exchange from ground to human body, high heat storage of ground.	Mean sunshine hours 58%, weekly average intensity 540 W/m ² , little reflection of solar from ground (but high reflection in gypsum areas).	Radiation intensity of 540 W/m ² .
Temperatures	Annual mean of maximum day temperature in shade ~ 35.6°C ¹⁸ and minimum night ~ 25°C, night cooling prevented by overcast sky, skin temperature seldom lower than day temperature, sky temperature about the same as air temperature, ground temperature relatively the same as air temperature, daily maximum reached 1~2 hours after mid-day, daily minimum reached 1~2 hours before sunrise.	Air temperature ranges from 20 to 34°C, with average of 27°C, cooler toward north, daily maximum reached 1~2 hour after mid-day (see Figure 3-14).	Maximum and minimum air temperatures are lower than generally found in other hot humid climate regions. The daily maximum reached near the end of ordinary office and school hours, around 14:00. Air temperature of 27°C is used in the experiment.
Precipitation	Over 2000 cm annually, 12.7- 7.62 cm monthly, rain usually in the afternoon, in a heavy storm 5.1-7.5 cm may fall in an hour.	1.3 - 0.5 cm monthly, rain usually in the afternoon, lightning and thunders are common during heavy rains.	The precipitation in Yogyakarta Special Regions is much lower than general conditions in other hot humid climate regions. However, it does not obviously affect the humidity. (see Humidity below)
Humidity	15-25 mb, RH 55-100%.	Relative humidity ranges from 70 to 90%; Monthly average humidity 80%.	Humidity is high, as generally found in hot humid climate.

Air movement	Low but strong during rain squalls, one or two dominant directions ¹⁹ , for low altitude regions usually easterly (Trade Wind Belt) ²⁰ .	Wind velocity ranges from 0 to 5.56 m/sec. With average of 3.53 m/s. Three major wind directions, 180, 210, and 240° clockwise from the north. The most frequent is 240°.	The wind sweep Javanese buildings from the direction between 180 and 240° (clockwise from the north) regardless the time of the year. Facing the Javanese buildings to that range of direction can optimise the ventilation potential of the roof.
Supplementary remarks	Climate difficult to tolerate, symptoms of fatigue, low bodily evaporation caused by high humidity and low air movement, frequent thunderstorms, high proportion of air to air electric discharge, organic building materials decay and metal corroded rapidly, abundant insects, excessive dust.	General features of hot humid climate are applicable. Symptoms of fatigue, sticky skin caused by sweat and low bodily evaporation, excessive dust, high pollution in the city. One of the fatigue symptoms can be seen easily at as the tendency for people to give up working after mid-day or even go home before the formal daily working hours end (at 14:15).	Negative body reaction symptoms detected in Yogyakarta matches with those found in hot humid climate in general.

Table 6-2 Hot humid climate building designs guidelines and Javanese customs and architecture guidelines.

Topics	Reference guidelines	Javanese customs and architecture guidelines	Comments
Concepts of a house	A place to live comfortably.	<i>Dalem (omah buri)</i> is a place to live and to express spiritual attitudes, social status and the material standing of the owner, it has a <i>soul</i> or <i>spirit</i> and should be treated carefully. ²¹	Spiritual values are an important part of Javanese house. A house is not just a place to live physically comfortable, but more importantly spiritually.

<p>Prospects of the design guidelines</p>	<p>Growing popularity as a result of a better education in architecture and building design as well as a better condition of society (economy, technology, education, etc.).</p>	<p>Faded out, modern people think that most traditional guidelines are related to superstition and are thus impractical for modern life conditions; however, some experts such as Prijotomo²² and Ronald²³ have tried to rediscover the basis of the traditional guidelines, which they claim to be <i>scientific</i>.</p>	<p>Scientific approach to Javanese building design is important to minimise its superstitious images and find its today practical application.</p>
<p>Timing of building construction</p>	<p>No specific time.</p>	<p>Detailed calculations²⁴ to select the best day to start construction using the Javanese calendar (based on moon's revolution and influenced by the Arab calendar system). For example²⁵: <i>Kasa</i>, good to build a house (the first season, the occupant will have a peaceful life, starts of the dry season), <i>Kalima</i>, good to build a house but not to move it (the fifth season, the occupant and their next generation will be safe, transition between dry and wet season).</p>	<p>Strong spiritual consideration in timing of building construction is unique for Javanese buildings; it is a part of the culture. It is intended to maximise the building quality, and the occupant's prosperity.</p>
<p>Construction</p>	<p>Guided by modern analytical methods of construction management, civil engineering, environmental design, etc.</p>	<p>Step by step construction accompanied by specific rituals and offerings²⁶, always related to spiritual thought, tend to rely on experiences (trial and error) handed down through generations.</p>	<p>Javanese construction is based on comprehensive experience, which is transformed into spiritual considerations.</p>

<p>Builders</p>	<p>Qualified architects, civil engineers, mechanical engineers, paid skilled and unskilled labours.</p>	<p>Groups of people called <i>Kalangs</i> who have different specialisation (<i>Kalang Blandhong</i>, cutting trees and timbers; <i>Kalang Obong</i>, opening and cleaning the sites; <i>Kalang Adeg</i>, constructing the buildings; <i>Kalang Breg</i>, renovating the buildings), skilled and unskilled assistants, mostly by <i>gotong royong</i> (unpaid, mutual work, neighbours as volunteers).</p>	<p>There are different specialisation in Javanese building construction</p>
<p>Site</p>	<p>Southern and northern slope directions are more desirable²⁷, wind-flow effects will remain the dominating consideration (as shading might be provided by other means)²⁸.</p>	<p>Detailed calculations^{29,30} to select the best site. For examples: <i>Indraprastha</i> (northern slope direction), good; <i>Sri Nugraha</i> (eastern slope direction), good; <i>Bumi Langupulawa</i> (at the brink of a cliff), good.</p>	<p>Spiritual consideration for Javanese building site.</p>
<p>Road orientation</p>	<p>Broad channel, E-W axis.³¹</p>	<p>No specific recommendation.</p>	
<p>Landscape</p>	<p>In flat areas the integrated use of water is both possible and desirable³²; utilise the psychological effect of falling water or large water bodies but minimise the humidity of small water ponds and low areas³³; water drainage should be provided away of the house; covered by grass (abs. 80%), grey sand (abs. 82%).</p>	<p>Grasses are not commonly used for site covers, moist soil (shaded by trees) reduces dust problems, small canals for water drainage usually encircle a house complex.</p>	<p>Unlike modern concepts of reducing dust problem, instead of using grasses, landscape around Javanese buildings use trees to keep the underneath soil moist. The trees also become barriers from the storm.</p>

Vegetation	Shaded trees should be high branching; low vegetation should be kept away from houses ³⁴ ; planting should shade structure whenever possible as well as outdoor spaces ³⁵ ; high canopy deciduous trees placed near building. ³⁶	Trees with high and low branching, every tree and its location has symbolic (spiritual) meaning.	Spiritual considerations are unique for Javanese vegetation. The recommended high and low trees (canopy like) become barrier during the storm, and reduce glare from the bright sky, while not blocking the low horizontal air movement. Trees block the early morning and late afternoon strong solar radiation.
Building orientation	Perpendicular to the axis of the overheated period (see original orientation chart in Olgyay) ³⁷ , or at 5° East of South with 10° deviation (for southern hemisphere it should be 5° east of North with 10° deviation); preferably to the direction of the prevailing wind ³⁸ , especially for the living and sleeping rooms ³⁹ ; oblique winds at angles between 30 and 120 degrees provide effective ventilation ⁴⁰ .	To the north or south, slightly skewed to the west or east. Not directly to the north or south. The palace faces east (<i>Batara Sang Hyang Maha Dewa</i> , King of Gods, the Creator), ordinary houses face south if located to the north of the palace, or face north (<i>Batara Sang Hyang Wisnu</i> , the God of Cares and Protection) if located to the south of the palace; facing west (<i>Batara Sang Hyang Yamadipati</i> , the God of Death) is strictly not recommended; facing the street (either north or south) is preferred.	The Javanese building orientation matches with modern building design recommendation, though it is based on spiritual consideration.
Building masses layout	Scattered or individual, pavilion-like arrangement ⁴¹ , wide spacing ⁴² , ventilation is the most effective way to minimise the physiological effect of high humidity ⁴³ .	Scattered building complexes, each complex consists of two or more attached/detached buildings.	The scattered mass layout of Javanese buildings matches with modern building design recommendation.
Building interior layout	Minimise obstacles ⁴⁴ .	Mostly simple plan.	The simplicity of Javanese building plan matches modern building design recommendation. It minimises airflow obstacle inside the building.

Space function	Highly flexible design, depends on individual ideas or requirements.	Flexible function of building style but should be rendered by <i>petungan</i> . The exception is <i>Tajug</i> , which can only be used for religious buildings. <i>Sri = dalem</i> (main house) <i>Kitri = pendapa</i> (semi public multi purpose space) <i>Gana = gandhok</i> (pavilion), <i>pawon</i> (kitchen) <i>Liyu = regol</i> (gates) <i>Pokah = lumbung</i> (rice store)	Function dictates building spiritual values (<i>petungan</i>), which affect the dimension of the building.
Form and volume	Individually developed buildings based on analytical considerations, free-styles, volume effect is undesirable ⁴⁵ (?).	Traditionally developed buildings: <i>Tajug</i> , <i>Joglo</i> , <i>Limasan</i> , <i>Kampung</i> (and <i>Panggung pe</i>), no extreme style differences, relatively large volume.	Javanese building forms were developed based on five basic forms; the similarity between buildings are high.
Ventilation	Cross ventilation and natural ventilation are based on physiological cooling; breeze across shaded lawns is desirable. ⁴⁶	Continuous ventilation through the roof; excessive exposure to the wind (especially after sunset) is not recommended as it invokes evil spirits.	Javanese buildings have different ventilation system with that recommended by modern building design. Javanese buildings apply roof ventilation systems; physiological cooling does not involve excessive exposure to the wind.
Materials	Material treatment recommended to reduce corrosion (non-organic) and decay (organic) risk; selection is based on material properties which match the weather.	Careful selection of good materials to assure future prosperity, for example: hard, smooth, oily, and fine fibrous teakwood that grows on red soil. ^{47,48}	Though use different ways to modern building design, Javanese building designs involve carefully selection of good materials, which is linked to spiritual values.
Ornament	No specific ornaments.	Complicated spiritual based ornaments. ⁴⁹	Javanese ornaments give unique aesthetic to Javanese building.

Thermal comfort	Every room generate its own standard based on its function	No standard recognised	Every space function generates different <i>petungan</i> (see Space Function above). As <i>petungan</i> affects the dimension of the buildings, it should also affect the thermal performance of Javanese buildings.
-----------------	--	------------------------	--

Table 6-3 Hot humid climate building designs guidelines for roof, walls, floors, and Javanese architecture.

Parts of building design		Reference guidelines	Javanese architecture guidelines	Comments
Roofs	Form	Most important (strongest thermal impacts occur here). Ventilated double roof is desirable; wide overhangs ⁵⁰ for rain protection and sky glare reduction (the rain often comes at 45° angle).	Given the most attention, the ridge (<i>molo</i>) has the highest status and sacred ⁵¹ . They do not necessarily have a ceiling, or wide overhangs (many are less than 50 cm), forms and dimensions are dictated by <i>petungan</i> , which is compulsory applied at <i>guru</i> sector. Forms were based on the five basic styles.	Spiritual values dictate the dimension of the roof. Forms are within the five groups of styles. Unlike general guidelines for hot humid climate regions, Javanese buildings do not have wide overhangs. (For overhang width refer to Drew ⁵² , Lippsmeier ⁵³ , or Koenigsberger. For roof dimension refer to Prijotomo. ⁵⁴)
	Material	Watertight, insulated and reflect solar rays; red clay tiles (reflectivity 30%) ⁵⁵ , corrugated asbestos cement sheets, aluminium foil to improve solar heat protection; should be light coloured, reflective and have good insulation qualities. ⁵⁶	Traditionally made red clay tiles or wood shingles for covers; bamboo (whole, split or woven) for ceilings. Ordinary people's buildings mainly use clay-tiles. Royal buildings use clay-tiles or wood shingles.	Javanese buildings use natural materials, which are good heat insulator. Clay tile roofs are porous, which provide ventilation. (For construction and material properties, refer to Lippsmeier ⁵⁷ and Koenigsberger. ⁵⁸)

Exterior walls	Form	<p>Less important than roofs (only for insect and privacy screening), structure should be sheltered from sun and rain⁵⁹, E-W long axis with optimum ratios between 1:1.7 and 1:3.0, openings should provide ventilation for 85% of the year, E-W cross ventilation, opening width is 40-80% of wall surface⁶¹; screening, louvres, jalousie and grills are useful⁶²; openings should provide inlet and outlet for air movement, individual cross ventilation for every room is recommended.⁶³</p>	<p>Relatively small windows with bars, windows tend to be for linking indoor (micro cosmos) to outdoor (macro cosmos) rather than ventilation⁶⁴. Window is not of Javanese origin. There is no specific guide for window and door placement.</p>	<p>Unlike modern guidelines, Javanese buildings do not consider walls' openings important. (For effects of windows' design and position on indoor air condition, refer to Kukreja⁶⁵ and Boutet⁶⁶ though not specifically designed for hot humid climate).</p>
Interior walls	Material	<p>Maximum reflectivity⁶⁷; reflective light colours in the pastel range are best⁶⁸; insect screens; light heat capacity⁶⁹, bamboo can be used⁷⁰ (renewable, low heat storage capacity, good ventilation, reflectivity 20%), or red fire clay brick (reflectivity 70%).⁷¹</p>	<p>Furnished or painted timber planks, white wash woven bamboos or red clay bricks, also in natural colours.</p>	<p>Javanese buildings use natural material for walls; they are of good heat insulator though heat gain is low as surrounding trees blocks the sun radiation.</p>
Interior walls	Form	<p>Limited (free plans) or movable and low partitions are desirable⁷², single banked rooms.⁷³</p>	<p>Simple or open layouts; <i>dalem</i> contains <i>dalem</i>, <i>gandhok kiwo</i>, <i>gandhok tengah</i> and <i>gandhok tengen</i>.</p>	<p>The interior layout of Javanese buildings matches with general recommendation for hot humid climate.</p>
Floors	Material	<p>Light materials</p>	<p>Timber planks, woven bamboos.</p>	<p>The material of interior walls matches with modern recommendation.</p>
	Form	<p>Basement is impractical (due to high humidity), building on high stilts provides better ventilation in living areas.</p>	<p>On ground floor but elevated.</p>	<p>Like modern guidelines, Javanese buildings have elevated floor (without space underneath).</p>

Material	Impervious to moisture ⁷⁴ ; paved floors (easy care and simple cleaning). ⁷⁵	Paved floors (compressed soil in villages, or locally available materials such as gypsum and sand).	Ordinary Javanese buildings use very simple materials.
----------	--	---	--

6.3 Theoretical Review of Aerodynamics and Thermal Performance of Javanese Buildings

This sub-chapter reviews theory relating the link between Javanese architectural rules and building science. Theoretical approaches guide the main experiments so that problems can be isolated. Any phenomena in Javanese architecture presumed to have environmental relevance are explained theoretically and isolated. This focuses, leads, and simplifies the experiments, as elements that do not have any potential environmental impact can be eliminated.

6.3.1 General and Specific (*petungan*) Guides and Javanese Building Forms

Petungan determines almost all aspects of Javanese building design. A simplified application should be made to avoid unmanageable experiments caused by too many variables.

Three steps allow for simplification:

- The discussion of any *suspicious* phenomena within Javanese building designs. Here, *suspicious* phenomena is something presumed to relate to thermal comfort performance. Meticulous consideration of this aspect should allow that western sciences are being applied to eastern phenomena; the *real ideas* behind such phenomena must not be overlooked.
- Selecting aspects of Javanese building to ensure facets with the greatest possible relevance to thermal comfort performance are tested.
- The number of variables is to be kept to a minimum; if necessary, variables should be converted to constants.

As mentioned, there are two kinds of design guides within Javanese architecture, general and special. General guides provide general design recommendations for Javanese buildings, and do not directly relate to *petungan*. Wall and floor designs, for example, do not appear specific, but builders prefer to follow some standardised rules (in selecting materials, making patterns, etc.). Conversely, *petungan* gives a specific guide, which must be followed. As a result, some generalised features of a Javanese building may make buildings look similar at first. However, in details these building are unique, as every structure becomes based on specific *petungan* considerations, which depend on the function of the building and the body of the owner (or builder). Some of the common guides have given Javanese buildings the general characteristics mentioned in Chapter Four. The specific guides (*petungan*) are also discussed there.

While general guides provide for broad characteristics of Javanese buildings, *petungan* is only strictly applied at *guru* sector. The influence of *petungan* on the whole form of a Javanese building is thus questionable. Chapter Four forms the conclusion that, despite its importance to

determine the *soul* or philosophical meaning of a building, it only makes a minor contribution to the building design as a whole. This, in combination with the general guides, Javanese buildings to be modelled, use general guides as constants, and *petungan* as variables.

Since *petungan* is only strictly applied at *guru* sector, its influence on the whole building form is not easily observed. It is thus possible for two buildings to have exactly the same form (created by general guides) except at *guru* sector (created by *petungan*). In this case, only a small difference at *guru* sector can be anticipated.

This raises a question regarding the effect of *guru* sector on the thermal performance of the whole building. In common sense terms, *guru* means someone respected for their specialist knowledge in a particular field. In Javanese building terms, *soko gurus* means the main posts which support the *guru* sector. *Guru* sector means the main sector, the centre. Philosophically, it refers to the heart of the house. However, whether this sector has any aerodynamic or thermal significance is neither known nor tested.

Applied strictly at the *guru* sector *petungan* then affects the dimension and proportion of that sector, while indirectly affecting the *pananggap* sector. *Petungan* relates to the area, volume, and the inclination of the roof. Do specific values within the dimension and proportion of the *guru* sector lead to certain aerodynamic and thermal performances contributing to a specific quality of indoor atmosphere?

Petungan and function are related, and located within supernatural considerations. The meanings of the relationship between *petungan* and building functionality involve abstraction and superstition. In modern building environmental design, each activity requires unique environmental conditions for people to be thermally comfortable. Thus, interior atmospheric design is dictated by the room's function. Is there any correlation between *petungan* and modern building environmental design? Does *petungan* unintentionally create atmospheric conditions suited to specific activities?

Differences due to *petungan* are relatively minor compared to overall building geometry. The popular *petungan sri-kitri-gana-liyu-pokah*, for example, can cause one to four unit differences. One unit might either equal one foot of standard unit, or the length of the owner's (or builder's) foot. If a *Joglo* is used as a *dalem* (the main place to live), its *petungan* should fall into *Sri* ($p=1$). The dimension of the *guru* sector (short *guru* beam x long *guru* beam; see Figure 4-4) can be 11'x16', 16'x21', etc. (see Figure 4-4.) But, if used as a *pendapa* (a place to

welcome and entertain guests), its *petungan* should fall into *kitri*. Thus, its *guru* sector can have such dimensions as 12'x17', 17'x22', etc. The two *joglos*, with *sri* and *kitri*, can have their *guru* sectors' dimension only slightly different, 11'x16' and 12'x17' respectively. Thus, physically *petungan* leads only to minor differences.

The use of the owner's or builder's body as a basic unit (ie. foot) for the whole measurement adds to the relativity of Javanese building dimensions. Despite the introduction of more precise standard units in late 1800s, inches and feet, there is no accurate description within literature as to its actual use in construction. Moreover, there is no evidence of the authorities' enforcement of that official unit standard at that time. Considering that the unit of measurement was based on an adult body, its tolerance can be assumed. If one Imperial Standard foot equals 30.48cm (Système International d'Unités), one determined by personal anthropometrics can be calculated as within the range of 25 ± 2 cm, being the average length and range of Javanese feet (*pecak*). Using relative units can cause two *joglos* with *petungan sri*, for example, to have different dimensions even though they use exactly the same formula. This underlines the tenuous connection between *petungan* and aerodynamic and thermal performance. However, although the use of relative units in *petungan* may cause two *joglo* to have different dimensions, their proportion might be kept consistent. Prijotomo⁷⁶ states that the application of *petungan* should not violate aesthetic values. *Kawruh kalang* dictates that while the dimension of Javanese buildings can be based on *guru* sector (with *petungan*) a good proportion must be maintained.

Given that *petungan* is only strictly applied at the *guru* sector, only giving minor physical effects, seems a negative sign. The application of *petungan* is flexible. One value (i.e. *sri*, *kitri*, *gana*, *liyu*, *pokah*) can be expressed in many ways (see Chapter Four). Thus, it becomes difficult (even nonsensical) to consider the contribution made by *petungan* to aerodynamic and thermal performance, as related to indoor air quality. Simply put, *petungan* might have no environmental significance.

Theoretically, though, *petungan*'s impact on the building environment occurs, regardless of its significance. *Petungan* must influence Javanese building aerodynamics and thermal performance, despite its apparent irrelevance. *Petungan* directly affects area, volume, and inclination of the roof at *guru* sector, indirectly affecting the *pananggap* sector; these three components directly relate to aerodynamic and thermal considerations.

Since Javanese buildings were designed using both specific (*petungan*) and general guides, their environmental performance should be considered the cumulative result of those

guides. *Petungan* cannot be separated from its parameters. Which contributes most significantly remains a question. Given that *petungan* is only applied at *guru* sector, general guides might be the principal determinant for Javanese environmental performance. Unlike *petungan*, general guides do not link directly to building function. Therefore, these guides create a standard environmental performance within Javanese buildings, to which *petungan* provide minimal adjustment. If Javanese buildings are assumed to be thermally comfortable, then general guides must have formed that image. *Petungan* gives philosophical closure (imputes philosophical meaning in the building) and physical completeness (adjusting the indoor environment to suit the activity). Clearly, this qualitative theory can only be confirmed through in-depth research.

6.3.2 Interrelationship among Javanese Building Forms, Materials, Aerodynamics and Heat Transfers

Understanding the effect of Javanese building forms and materials on their aerodynamics and heat transfer performance is important. These latter factors determine whether combinations of indoor atmospheric factors (in this case air velocity, humidity, temperature, and mean radiant temperature) are thermally comfortable. Table 6-4 summarises the relevance of Javanese buildings' forms and materials to their indoor thermal comfort performance factors; the aerodynamics and thermal performances.

The effect of building forms and materials on building aerodynamics and heat transfer performance describes inter-dependency. No single association can be isolated from the other factors, which are inevitably dependent. Form, for example, might have a major impact on the aerodynamics of the building or the quality of airflow within and around buildings. However, this airflow affects heat transfer through convection between the air and the surroundings surfaces as well as between the air and human body. The form of the building also determines the heat transfer by radiation between surfaces and human body. On the other hand, building materials not only relate to heat transfer but also to aerodynamics. Traditionally made clay tiles, for example, are not only assumed to be a good insulator but also a good ventilator (as they are not airtight). In identifying major and minor relationships, the table directly relates form, materials, aerodynamics, and heat transfer to six aspects of thermal comfort (air temperature, air velocity, humidity, mean radiant temperature, clothing value, and metabolic rate).

Considering that in hot humid regions, all thermal comfort aspects (T, RH, MRT) should be minimised (except the air velocity which should be maximised) further assumptions can be made. If that consideration is generally correct, then the forms and materials of Javanese

buildings (developed over generations) might have also been intended to minimise all thermal comfort aspects except the air velocity.

References relate the optimisation of air velocity to the physiological cooling of the body. This might conflict with the Javanese belief that wind (especially after sunset) contains evil spirits and that excessive exposure of the body to that wind should be avoided. This may explain why Javanese buildings only have restricted openings. Javanese ancestors mostly remained indoors after sunset (working outdoors during the daytime), and avoided the after-sunset wind. Openings were thus less important. However, assuming they also need comfortable housing, their strategy involved the reduction of indoor air temperatures, creating cool atmospheres, without necessarily introducing perceptible airflows. This might be the secret to the environmental design inherent to the Javanese architectural orders.

The basic indoor environmental design rule in warm humid regions is to minimise heat gain and to maximise heat loss. The most significant external heat source is the sun, which heats building surfaces (roofs and walls). These heated surfaces transfer their heat to surroundings air and bodies by conduction, convection, and radiation. Interior heat sources include the households.

To get preliminary ideas on the thermal performance of Javanese buildings, the following formulae (Formulae 1 to 4) can be used. Those formulae have been developed to represent heat transfer processes around materials. In this discussion a regressive method is used. The relationship between variables in those formulae are used to explain the Javanese roof. Examples of more complicated calculations of heat transfer by convection, radiation, and conduction at the roof can be found in Satwiko's work.⁷⁷

$$t = t_o + (I \cos \theta \alpha) / f_o \quad (1)$$

- where t = outer surface temperature following exposure to the sun for a period of time
 t_o = initial surface temperature, °C
 I = solar radiation intensity, W/m²
 θ = angle between a surface and a plane perpendicular to the sun radiation
 $\cos \theta$ = cosine of the surface angle
 α = absorptivity
 f_o = surface (or film) conductance, W/m²°C

Say subscript ₁ and ₂ indicate surfaces one and two respectively, and the remaining variables are the same:

- If $\theta_1 > \theta_2$, then $\cos \theta_1 < \cos \theta_2$, resulting in $t_1 < t_2$. Thus, a steep surface will have an outside and inside surface temperature difference less than surface of shallower gradient.
- If $\alpha_1 > \alpha_2$, then $t_1 > t_2$. Thus, a material of higher heat absorbance will have an outside and inside surface temperature difference higher than a material of lower heat absorbance.
- f_o is a function of the surface qualities, and of the velocity of air passing across the surface. Coarser surfaces and faster air velocities will result in a greater magnitude of f_o than smoother surfaces and slower air velocities. If $(f_o)_1 > (f_o)_2$, then $t_1 < t_2$. Thus, a coarser surface will have a lower outside and inside surface temperature difference than a smoother surface. Also, a surface swept by a higher air velocity will have an outside and inside surface temperature difference which is less than the surface which is swept by a lower air velocity.

The rate of heat flow by conduction (from outside to inside surfaces) can be calculated using the following simple formula:

$$Q_c = A.U.\Delta T \quad (2)$$

where Q_c = conduction heat flow rate, W
 A = surface area, m^2
 U = transmittance, $W/m^{2\circ}C$
 ΔT = temperature difference between outside and inside surface, $^{\circ}C$

- If $A_1 > A_2$, then $(Q_c)_1 > (Q_c)_2$. Clearly, a wider surface will have a higher conduction heat flow rate than a narrower surface.
- If $U_1 > U_2$, then $(Q_c)_1 > (Q_c)_2$. A material with higher transmittance will have higher conduction heat flow rate than a surface with lower transmittance. The following equation describes the concept of transmittance.

$$R_a = 1/f_i + R_b + 1/f_o \quad (3)$$

where R_a = air to air resistance, $m^{2\circ}C/W$
 $1/f_i$ = internal air resistance, $m^{2\circ}C/W$
 R_b = body resistance, $m^{2\circ}C/W$
 $1/f_o$ = external air resistance, $m^{2\circ}C/W$
 $1/R_a = U$ = air to air transmittance, $W/m^{2\circ}C$

- Materials with higher resistance will have lower transmittance, and consequently lower conduction heat flow.
- If $(\Delta T)_1 > (\Delta T)_2$, then $(Q_c)_1 > (Q_c)_2$. A surface with a higher temperature difference between its two sides will have a higher conduction heat flow.

Meanwhile, the temperature increase of materials can be calculated using the following formula:

$$\Delta T = I \cos \theta \alpha / (c \rho \delta) \quad (4)$$

where ΔT = temperature increase over a period of time, °C
 I = solar radiation intensity, W/m²
 θ = angle of the surface to a plane perpendicular to the solar radiation
 $\cos \theta$ = cosine of the surface angle
 c = specific heat, J/kg°C (or Ws/ kg°C)
 ρ = density, kg/m³
 δ = thickness, m

- If $c_1 > c_2$, then $(\Delta T)_1 < (\Delta T)_2$. Materials with higher specific heat will have a lower temperature increase than materials with lower specific heat.
- If $\rho_1 > \rho_2$, then $(\Delta T)_1 < (\Delta T)_2$. Materials with higher density will increase their temperature less than materials with lower density. In practice this is not obvious, high-density materials (such as metals) tend to have significantly lower specific heat than low density materials (such as woods).
- If $\delta_1 > \delta_2$, then $(\Delta T)_1 < (\Delta T)_2$. Thicker materials will have a lower temperature increase than thinner materials.

Table 6-4 summarises the predicted influence exerted by Javanese architectural orders on indoor thermal comfort factors. (Note: This table has been created and condensed by predicting the influence of Javanese architectural orders on indoor thermal comfort factors. As walls and floors are only minor issues in Javanese architectural orders they can be more simplified into constants and leave roofs as variables.) In this table, the relationship between building elements and indoor thermal comfort factors are identified. It shows that every design aspect has a unique relation to thermal comfort factors. Roof forms, for example, affect building thermal comfort by influencing air velocity, airflow pattern, air temperature, and mean radiant temperature. This table helps focus the theoretical approaches to Javanese building environmental performance. It is also useful to guide the experiments by identifying the relevant aspects; for example, heat capacity and conductivity of the roofing material will be a major consideration in the thermal performance experiments, while its porosity will become a major consideration in the aerodynamics experiments.

Table 6-4 Prediction of the Influence of Javanese Architectural Orders to Indoor Thermal Comfort Factors

		Indoor thermal comfort factors						Comments
Areas	Component	aerodynamics		heat transfer		psycho-physics		
		V	air flow pattern	T	MRT	RH	met	clo
	Sub-component	Maximized	Optimized	Minimized	Minimized	Minimized	Minimized	met and clo are not considered to have direct connection with buildings. Javanese people are characterised for doing things slowly. Their informal dress is mostly of light linen and leaves most parts of the body uncovered.
								In a warm humid climate region, the building environmental control strategy should maximise air movement and minimise other factors.
Javanese architecture: traditional orders								Literature on Javanese architectural orders takes two approaches, functionally and characteristically.
Roof	Form	✓	✓	✓	✓			The Javanese architectural orders are mainly emphasised through roof design. There are five roof styles: <i>Panggang pe</i> , <i>Kampung</i> , <i>Limasan</i> , <i>Joglo</i> and <i>Tajug</i> . Each group has some variants. The unique 3D geometrical forms of each roof style are predicted to influence the immediate outdoor air movement which will in turn affect the indoor air movement (eg. Velocity and pattern). The position of roof surfaces relative to a point within the occupants' zone will determine the effect of MRT on the human body at this point.
	3D geometrical form							

	Volume created by specific proportions of dimensions	✓	✓					<p>Most Javanese architectural orders involve the application or expression of <i>petungan</i> (numerology) within building dimensions. As the dimensions of roofs are sometimes based on owners' or builders' body parts, roofs can have a different volume, even within the same style. There remains opportunity to use a more precise measurement, such as feet, inches, and stripes. Volumes created by specific proportions of dimensions are predicted to affect the air velocity and pattern (eg. the chance for turbulence and vortex to develop) as well as the requirements of air change per hour. Horizontally separate construction ceilings are not demanded in Javanese architecture. Ceilings directly attached to the roof construction or no ceilings at all are more common, creating a bigger indoor air volume.</p>
Material	Heat capacity, conductivity		✓	✓				<p>Different roof styles can utilise same materials. Common materials include clay tiles and wood shingles for cover plus bamboo and/or timbers for construction. If ceilings are applied, the most common materials are whole bamboo, woven bamboo, or timber planks. The heat capacity and conductivity of the materials will determine, respectively, the rate of the surfaces' temperature increase, and the rate of heat flow (from outer to inner surfaces) after being exposed to the sun for a certain time. Clay tiles, wood shingles, and bamboos are well known as good heat insulators, requiring more time for the sun to heat them.</p>

	Porosity	✓	✓			✓			<p>Traditional non-fabricated clay tiles cannot fit tightly, leaving gaps. This is predicted to influence the indoor air movement, as the outdoor air not only penetrates openings in the walls, but also through the gaps in the roof. This air path is also predicted to affect the relative humidity inside the building, as the air changes continuously.</p>
	Texture			✓	✓				<p>Surface textures affect absorptivity and emissivity, as well as the wind speed along these surfaces. Rough surfaces have higher surface shear stress than smooth surfaces. Highly textured surfaces provide more areas of contact with the air which affect the heat transfer rate by convection between surfaces and the air. Javanese roofs are highly textured.</p>
	Colour			✓	✓				<p>Surface colours affect their absorptivity and emissivity. Darker coloured surfaces tend to have higher absorptivity than bright surfaces. Javanese roofs apply dark colour surfaces.</p>
Wall; external	Height and Width	✓	✓						<p>The proportion and dimension of a wall's width and height affect air movement around the building. Javanese architecture has various standardised proportions of width and height. They are indirectly influenced by the application of <i>petungan</i> at <i>guru</i> sectors.</p>

		✓	✓				✓		✓				Internal walls have doors with or without door leaves.
Floor	Form	✓	✓				✓		✓				Raised floors are believed expose the building to more wind. In Javanese architecture, floors are given the least attention. Javanese buildings do not use a stilted floor, although the floors are usually elevated more than 30 cm.

Note: The table above has been created and condensed by predicting the influence of Javanese architectural orders on indoor thermal comfort factors. As walls and floors are only minor issues in Javanese architectural orders they can be more simplified into constants and leave roofs as variables.

Table 6-5 Heat transfer process between the human body and its surroundings.

Heat transfer process	Conditions	Determinants
Conduction	Contact with surfaces, eg. feet on floors	<ul style="list-style-type: none"> • temperature difference between contact surfaces and the part of the body • area of contact
Radiation	Exposed to surrounding surfaces	<ul style="list-style-type: none"> • temperature difference between surfaces and exposed parts of the body • properties of the surfaces (emissivity and absorption) • position of surfaces relative to the body
Convection	Contact with air movement	<ul style="list-style-type: none"> • temperature difference between the air and body • air speed • air humidity • body coverage

The heat transfer process between the human body and its environment influences thermal comfort. Table 6-5 shows that the process involves conduction, radiation, and convection, illustrating this connection.

There are some features of Javanese building design that are presumably linked to the minimisation of heat gain and maximisation of heat loss (See Table 6-4 and Table 6-5):

- A pitched roof (relative to the sun radiation) means wider surface area per unit of sunbeam projection compared to a perpendicular surface. This enables solar radiation to be spread over wider areas, reducing the rate of temperature increase. Given the same area of ground projection (the effective footprint of the roof), three-point-inclination - high ridge roofs will have wider surface areas than single pitch - low ridge roofs. Constructed of the same material and subjected to the same solar radiation, the former will have a lower rate of temperature increase than the latter.
- Contoured surface materials provide wider surfaces than smooth ones. There are two advantages of contoured surfaces: the wide areas reduce the rate of temperature increase and provide wider contact areas between surface and airflow. Wider contact surfaces mean higher heat transfer between the air and the surfaces by convection. One of the most common roofing materials in Java is clay tiles. These traditionally handmade materials are grainy and highly contoured.
- Traditional handmade clay tiles are usually *arranged* in such a way that each individual tile can be ventilated by airflow on both its sides. This prevents solar heat from accumulating at

the tiles. Also, it affects the surface conductance. The Javanese roof can be considered highly porous.

- Low conductivity - high capacity materials delay both the temperature increase of the house's inner surface and the temperature increase of the materials. Javanese buildings use natural materials, which have low conductivity and high capacity. These delay the indoor temperature increase and minimise indoor heat gain. Walls, for example, might be exposed to direct sun radiation for just a few hours (early and late sun radiation is blocked by surroundings trees and high sun radiation is blocked by overhangs). Low conductivity and high capacity materials considerably reduce the rate of the sun heat (that directly strikes the outer wall surfaces for only a few hours) to transfer to the inner wall surfaces.
- Faster airflows on surfaces encourage more heat transfers. Some geometrical forms can accelerate the wind speed passing them. This means more heat transfer between the air and the surfaces thus helps releasing some parts of the heat gain from the surfaces to the air before it is used wholly to raise the surfaces' temperatures.
- Roof pitches affect the mean radiant temperatures received by the human body. Heat transfer from surfaces to the human body by radiation is affected by the position and area of the surfaces *seen* by human body.

6.3.3 Javanese Building and Indoor Thermal Comfort

A theoretical approach gives positive signs that Javanese building design might contain hidden rules for comfort. Many phenomena can be theoretically explained as significant to the achievement of thermal comfort in hot humid regions. However, it does not necessarily follow the modern strategy of minimising air temperature, humidity, and mean radiant temperature while maximising air speed. This approach such as maximising air speed, is still debatable. Although it works, it is debatable as to whether local Javanese people, as described earlier, are likely to accept it. However, there is no doubt that Javanese architecture does manipulate wind flow, indirectly, to create comfort.

It seems that Javanese design successfully generates comfortable buildings. But, the path leading to the end products might not always relate to modern building science recommendations. After discussing all the predicted relations between Javanese building design aspects and thermal comfort factors (see Table 6-4 and Table 6-5) another simplified list can be made:

Table 6-6 Assumption of the links between design and thermal comfort.

Factors	Comments
Air Temperature	The geometry of the Javanese roof (multi-levelled) prevents the indoor air temperature from increasing. Meanwhile, traditional material properties (porosity, conductivity, etc.) also prevent the penetration of external heat (from the sun).
Air Velocity	Geometric and material properties form a unique airflow pattern inside the roof, which guarantees the continuous air exchanges without necessarily producing perceptible air movement.
Air humidity	No obvious processes controlling indoor air humidity within building designs. Elevated floor and separate kitchen and bathroom (water vapour sources) might avoid humidity increase, where it is already high
Mean Radiant Temperature	The geometry of the roof creates a lower radiative heat transfer between the roof and the human body by reducing perpendicular (normal) radiation; the low temperature of the heat resistant material of the roof means lower radiative heat transfer.
Clothing values	Light textiles and less body coverage means lower clothing values.
Metabolic rate	Slow body movements and less intense activity mean lower metabolic rate.

6.4 Indoor Thermal Comfort and the Occupants' Zones

This sub section discusses indoor thermal comfort and the occupants' zones. It is based on several scenarios imitating past and future situations.

6.4.1 The Six Related Aspects

In this research, evaluation on thermal comfort uses available methods found in textual references. Six related factors, including air temperature, air velocity, air humidity, Mean Radiant Temperature (MRT), clothing values (clo), and metabolic rates (met) are mostly utilised. These are considered sufficient to justify whether an indoor atmospheric condition is thermally comfortable or not. However, other opinions suggest inclusion of additional aspects that might affect thermal comfort, such as turbulence intensity⁷⁸, gender, and race.⁷⁹

Some of the thermal comfort standards for warm humid climates can be derived from general standards such as the psychrometric chart^{80,81}, the ET (Effective Temperature) chart⁸² and the bio-climatic chart⁸³ (see Table 6-7). However, a study conducted by Bergera and Deval warns thus:

“The prediction of thermal comfort based on common procedures may lead to errors when applied to tropical humid conditions. The importance of humidity

in such cases has been overlooked.”⁸⁴

They also wrote of the incorrectness of establishing a direct correlation between an instantaneous situation and its felt impression; the climatological situation, human activity, difference valuations in heat, humidity, respiration, perspiration, ambience, and personal status should also be concerned. Karyono, too, warns about the cautious use of available standards (see Chapter One).⁸⁵

Table 6-7 shows Webb, Mom, Ellis, and Rao, based on Houghton and Yaglou Effective Air Temperature Diagram, give thermal comfort ranges from 20 to 27.2 ET* (Effective Temperature). It equals a combination of 20 to 29°C air temperatures with 0.1 to 1.5 m/s air velocities (and 1.0 clo.). The Department of Public Services of Indonesia⁸⁶ published a simple guide for thermal comfort. It gives a range of 24 to 27°C. It is not, however, accompanied by any explanation of its theoretical background, or any required standardised condition. There is no specific range for Javanese. However, Table 6-7 shows that Fanger’s comfort equations involve the six related aspects, which are thus more flexible to be used as assessment tool in the experiments; clothing values and metabolic rate can be easily adjusted to represent the culture influences.

Many experiments were carried out in the 1970s to validate Fanger’s comfort equation, mainly on lightly clothed sedentary people in environmental chambers. Those experiments included the influence of such variables as age, race, seasonal variations, adaptation, and background colour and noise on the preferred temperature. Olesen reports the results that the variation in the preferred temperature by the people tested was within 1.5 K.⁸⁷

6.4.2 Occupants’ Behaviours

Sensation of thermal comfort is affected by people’s behaviour. Two behaviours directly influential of the thermal sensation involve activities and clothing. These are often closely related. For example, farmers go to the rice fields wearing shorts and a T-shirt; they would not wear a formal suit. A person reading inside a house could wear anything.

Changing lifestyles have marginally altered people’s activities. Table 6-8 shows the met values of some activities that might occur inside a Javanese building, in both the past and the present day. There is no indication that basic activities such as eating, sleeping, and walking have changed. The time spent on them and additional activities can be logically explained. Introduction of electricity and modern electronic entertainment is considered to have affected sleeping habits. Programmes on television, for example, encourage people to delay their bedtime.

Table 6-7 Summary of thermal comfort standards.

Standard	Condition	Range of parameters
Based on Houghton and Yaglou Effective Air Temperature Diagram:	Combination of air temperature, humidity and air velocity.	
Webb ⁸⁸	Malays, Chinese in Singapore	25 - 27.2 ET* (a combination of 25-29°C with 0.1-1.5m/s; no detail available)
Mom ⁸⁹	Indonesians in Jakarta	20 - 26.1 ET* (a combination of 20-28.3°C with 0.1-1.5m/s; no detail available)
Ellis ⁹⁰	European in Singapore	22.2 – 26.1 ET* (a combination of 22.2-28.3°C with 0.1-1.5m/s; no detail available)
Rao ⁹¹	Indians	20 - 24.4 ET* (a combination of 20-26.5°C with 0.1-1.5m/s)
Victor Olgyay Bioclimatic Chart	Combination of air temperature, humidity and air velocity.	Combination of: Air temperature 22 – 30°C Relative humidity 30 – 65% Air velocity 0- 0.1 m/s
Department of Public Services of Indonesia ⁹²	(No explanations)	Combinations of: air temperature 24 - 27 °C relative humidity 40 - 70 % air velocity 0.08 - 0.125 m/s.; no detail available
Fanger's Comfort Equations	Combination of air temperature, humidity, velocity, Mean Radiant Temperature of surrounding surfaces, human activities and clothing, and other related aspects (skin temperature, etc.)	No specific combinations, the thermal comfort is valued using a scale of: -3, -2, -1, 0, +1, +2, +3 with 0 as neutral.

In general, the time pattern for indoor activities may have changed over time. During the day people used to go out to the rice fields, markets, etc. Now, they might go to the office, shop, school, etc. Evening life has been altered by more public activity and entertainment, including movies, exhibitions, and malls. Thus, people have more opportunities to spend time out during the evening.

Table 6-8 Past and present activities inside the buildings.

Past		Present	
activities	met rates	activities	Met rates
reading	1.0	reading	1.0
sleeping	0.8	sleeping	0.8
sedentary works	1.0	sedentary works	1.0
eating	1.2	eating	1.2
cooking	1.8	cooking	1.8
housecleaning	2.7	housecleaning	2.7
Entertaining	1.0	Entertaining	1.0
		Homework of jobs	1.5

Note: This table contains only general activities, based on interviews and field observations. The met values of some specific activities are found in ASHRAE Thermal Comfort Program.

Activities were traditionally slowly done. A characteristic phenomenon relating to the Javanese people is the speed at which they work. Everything seems to be done slowly, and sometimes appears not to be taken seriously. This is not deemed suitable for modern life, where fast thinking and action are necessary. However, this is inherit to Javanese culture itself, where peacefulness has been given a high priority in life. Everything should be enjoyable. Eating, for example, is not just a matter of health or the human need for energy, but also something that should be praised and enjoyable. The Javanese like to cook complicated foods and eat them slowly.⁹³ This *no-rush* behaviour is actually a logical bodily reaction to a hot humid climate. Slower movements require a lower metabolic rate. Table 6-9 shows metabolic rates for different activities found in literature.

Table 6-9 Metabolic rate of different activities.⁹⁴

Activity	Metabolic rate	
	(W/m ²)	(met)
Reclining	46	0.8
Seated, relaxed	58	1.0
Standing, relaxed	70	1.2
Sedentary activity (office, dwelling, school, laboratory)	70	1.2
Standing activity (shopping, laboratory, light industry)	93	1.6
Standing activity (shop assistant, domestic work, machine work)	116	2.0
Medium activity (heavy machine work, garage work)	165	2.8

1 met = 58.15W/m²

As has been mentioned, Javanese people wear light clothes most of the time. For a special occasion, such as wedding parties or ceremonies, they might wear slightly *heavier* clothes. However, even in a wedding party, the bride can wear a light dress, applying bare breasted style. Table 6-10 shows thermal resistance of clothing ensemble as found in literature. This table is used in conjunction with a table found in ASHRAE Comfort Program to predict Javanese clothing values.

Table 6-10 Thermal resistance of clothing ensembles.⁹⁵

Clothing ensemble	I _{cl}	
	(m ² °K/W)	(clo)
Nude	0	0
Shorts	0.015	0.1
Typical tropical clothing ensemble: briefs, shorts, open-neck shirt with short sleeves, light socks and sandals	0.045	0.3
Light summer clothing: briefs, long lightweight trousers, open-neck shirt with short sleeves, light socks and shoes	0.08	0.5
Light working ensemble: light underwear, cotton work shirt with long sleeves, work trousers, woollen socks and shoes	0.11	0.7
Typical indoor winter clothing ensembles: underwear, shirt with long sleeves, trousers, jacket or sweater with long sleeves, heavy socks and shoes	0.16	1.0
Heavy traditional European business suit: cotton underwear with long legs and sleeves, shirt, suit including trousers, jacket and waistcoat, woollen socks and heavy shoes	0.23	1.5

1 clo = 0.155 m²K/W

Table 6-11 describes both traditional and modern styles of clothing. It should be noted that this table is based on the most common clothing. People in modern life still wear traditional clothing. In the villages, people are still keen to wear old-fashioned clothes. Particularly during hot, lazy days, regardless their lifestyle, men tend to be either bare breasted or wear a shirt, and no sandals. The met values are based on ASHRAE Thermal Comfort Program.⁹⁶

During the field study, it was found that most occupants wore very light clothes. Mostly, men wore a single piece T-shirt (or merely underwear) and shorts (or sarong) with bare feet (sandals and shoes were left outdoors to keep floors clean). Women wore a light dress as well. It was also discovered that some occupants (men) were bare breasted and only wore clothes if they had visitors.

Table 6-11 Past and present clothing.

Old scenarios		Modern scenarios	
Clothing	clo values	Clothing	clo values
Bare breasted, shorts	0.10	Underwear, shorts, sandals	0.10
Bare breasted, sarong	0.15	Bare breasted, sarong, sandals	0.15
T-shirt, short	0.18	T-shirt, short, sandals	0.18
Short sleeves, trousers	0.36	Under wear, short sleeves, trousers	0.44
Informal traditional shirt and pants (or sarong)	0.29	Light business suit: underwear, long sleeves, trousers, shoes and socks	0.49
Formal traditional suits, sandals.	0.29	Formal business suit: underwear, light long sleeves shirt, trousers, suit, shoes, socks	1.17

Note: This table is based on interviews and field observations.

6.4.3 Sources of Heat and Water Vapour

Heat inside a building can be generated from external and internal heat sources. While the most obvious external heat source is the sun, common internal heat sources include the human body (as a result of metabolism) and household activities (energised by electricity, kerosene, or wood). Before the introduction of electricity, kerosene and wood were used. Kerosene was mainly used for lamps, wood was used for cooking.

There might be differences in external heat sources between the past and present days. The most obvious is the presence of combustion engines in vehicles and industrial equipment. There is also, for the sake of development, a significant conversion from natural elements to man-made constructions (roads, massive concrete buildings, etc.). These are believed to have contributed urban temperature increases.

Internal heat sources are also different. The field study revealed that electricity was installed in all ten buildings. Electricity was used for many purposes, but mostly for lighting. Other popular home equipment using electricity were sound systems and televisions. A freezer, washing machine, computer, and fans were found in different buildings. Many appliances are still considered luxurious.

Although preferable, electricity's usage remains limited. Kerosene lamps and stoves are widely used, especially in the villages. Even wood fires are still used. For residential buildings, the average power installed is usually 450Watts (220V) for the whole building. This small provision of fixed rate power installation is mostly used for lighting and entertainment (stereos and televisions). It can be upgraded, for example, to 900 Watts. Incandescent and fluorescent lamps with low wattage (10, 15, 20, 40 and 60 watts) are mostly used. An electric stove, oven, microwave, drier, or air conditioner are still unattainable to most people.

In terms of humidity, Javanese building designs have some advantages in, at least, avoiding additional water vapour entering the main building, the *dalem*. The kitchen and bathroom, being the main sources of water vapour, are separated from the *dalem*. Elevated floors also minimise the damp air layer from the external ground entering the room.

6.4.4 Occupants' Zones

As previously discussed, thermal comfort is based on the condition within the occupants' zones. Occupants' zones are areas within the building where occupants move. Thus, the location of activities (e.g. bed for sleeping, dining table for eating, TV for entertainment) and circulation (e.g. space between doors and the location of activities) determine this. Vertically, these zones can be measured from the floor's height to approximately 2000 millimetres above

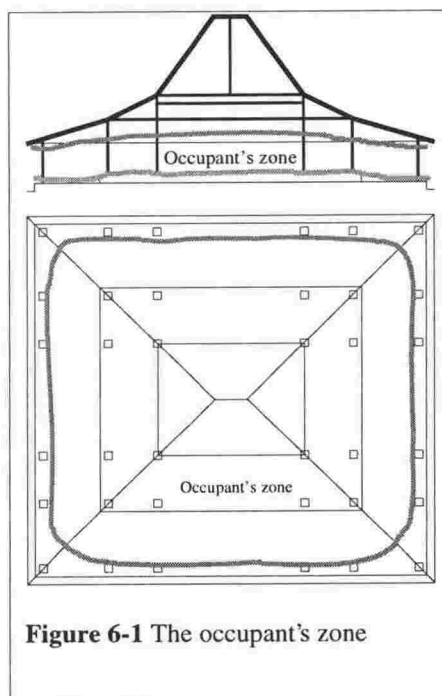

Figure 6-1 The occupant's zone

the floor. Practically, an occupant's zone is a part of a building's volume specifically where people live.

As people live in the occupant's zone, they experience and assess the thermal comfort performance of their building. This is an important consideration, as within a building the conditions of indoor atmosphere can be different between positions, vertically and horizontally. A thermally comfortable condition at one position does not necessarily reflect the same values in other positions. Moreover, there is no purpose in obtaining thermal comfort in a position, which will never be occupied. An example of occupants' zones is shown in Figure 6-1.

6.5 Summary

- Almost any single aspect of a Javanese building can be scientifically explained in relation to thermal comfort. Most recommendations for hot-humid building environmental design found within modern literature have already been applied in traditional Javanese designs. However, there are physical and non-physical conditions which influence the Javanese building designs.
- From the information lists of Table 6-1, Table 6-2, and Table 6-3 useful information for experiment of Javanese building thermal comfort performance can be derived (will be discussed further in chapters on experiments):
 - Flow domain consists of wind with atmospheric boundary layer, with the wind direction perpendicular to the long axis of the building. The average normal atmospheric condition of Yogyakarta Special Regions can be used to define the flow properties (air temperature, air velocity, humidity, etc.)
 - The building is a single-room standing-alone building.
 - The form of the roof is either of *Joglo* or *Limasan* style, with its *guru* sector's dimensioning strictly dictated by *petungan*.
 - Roof form (style, dimension, overhangs, etc.) and material properties (conductivity, porosity, etc.) are important and should be observed in detail.
 - Walls' openings are closed; walls are adiabatic, no heat gain caused by solar radiation.
 - Elevated floor is applied.
 - Thermal comfort is assessed based on occupants' doing sedentary works and wearing light clothes.
- Table 6-12 represents possible scenarios based on the most possible minimum, average, and maximum conditions in and around Javanese buildings, which influence indoor thermal comfort. This table reduces the indefinite numbers of variable combinations to simplify the experiments.

Table 6-12 Scenario

Atmospheric/climatic			Topography/geography			Human		
The sun radiation intensity, W/m ²	Minimum, cloudy	360	Ground roughness height, RH	Stands alone surrounded by paddy field, terrain category 2	0.03	Clothing values, clo	Minimal; Bare breast, shorts, bare foot	0.1
	Average, scattered clouds	540		Surrounded by woods, terrain category 3	0.3		Average; T-shirt, short or sarong, sandal	0.3
	Maximum, clear sky	1000		In the city, surrounded by multi-level buildings, terrain category 4	3		Maximum; formal cloth for ceremony: hat, T-shirt, long sleeve shirt, half-length pants, sandals	0.4
Air temperature, °C	Minimum	20	Atmospheric boundary layer, thickness, m	Stands alone surrounded by paddy field, terrain category 2	300	Metabolic rate, met	Minimum; sleeping soundly	0.8
	Average	27		Surrounded by woods, terrain category 3	400		Average; relax, reading, chatting	1.0
	Maximum	34		In the city, surrounded by multi-level buildings, terrain category 4	500		Maximum; sedentary work,	1.2
Air velocity, m/s	Minimum, calm	0						
	Average, normal	3.53						
	Maximum, windy	5.56						
Air humidity, %	Minimum, noon, bright sun	70						
	Average	80						
	Maximum, morning or after raining	90						
Wind direction, degree from the north	Minor, the third most frequent direction	180						
	Average, the second most frequent direction	210						
	Major, the most frequent direction	240						

Sky conditions, estimated duration of constant solar radiation, hour	Heavy overcast cloud	0						
	Normal, intermittent cloud	1						
	Clear sky	2						

The following chapter (Chapter Seven) discusses the computational fluid dynamics program.

Endnotes

¹ Searching libraries, publishers, and bookshops through the internet did not reveal a single book written on warm-humid tropical building designs.

² Koenigsberger, O., Ingersol, T.G., Mayhew, A., and Szokolay, S.V., 1973, Manual of Tropical Housing and Buildings, Part 1: Climatic Design, Bombay: Orient Longman.

³ Lippsmeier, G., 1969, Building in the Tropics, Munchen: Calwey Verlag.

⁴ Kukreja, C.P., 1978, Tropical Architecture, New Delhi: Tata McGraw-Hill Publishing Company Limited.

⁵ Drew M.F. and Drew J., 1982, Tropical Architecture in the Dry and Humid Zones, Malabar: Fla.: R.E. Krieger Pub. Co.

⁶ Manguwijaya, Y.B., 1980, Pasal-Pasal Penghantar Fisika Bangunan, Jakarta: PT Gramedia.

⁷ Lim, B.B.P., ed., 1988, Control of the External Environment of Buildings, Singapore: Singapore University Press.

⁸ Koenigsberger, O., Lynn, R., 1965, Roofs in the Warm Humid Tropics, London: Lund Humphries.

⁹ Boutet, T.S., 1987, Controlling Air Movement: A Manual for Architects and Builders, New York: Mc Graw Hill.

¹⁰ Awbi, H.B., 1991, Ventilation of Buildings, London: Chapman and Hall.

¹¹ Aynsley, R.M., Melbourne, W. and Vickery, B.J., 1977, Architectural Aerodynamics, London: Applied Science Publisher, Ltd.

¹² Olgyay, V. And Olgyay, A., 1969, Design with Climate, Bioclimatic Approach to Architectural Regionalism, Princeton, New Jersey: Princeton University Press.

¹³ Fanger, P.O., 1970, Thermal Comfort, Analysis and Applications in Environmental Engineering, New York: McGraw-Hill Book Company.

¹⁴ The list below is adopted from Lippsmeier.

¹⁵ Drew , op. cit., p.5.

¹⁶ Ibid.

¹⁷ Koenigsberger, 1973, op.cit., p.26.

-
- ¹⁸ Lippsmeier gives a figure of 35.6°C on the other hand Drew states that air temperature of 32.2°C rarely exceeded.
- ¹⁹ Koenigseberger, 1973, loc.cit., p.26.
- ²⁰ Awbi, op.cit., p.26.
- ²¹ Dakung, S., 1981, Arsitektur Tradisional Daerah Istimewa Yogyakarta, Yogyakarta: Dep. Pendidikan dan Kebudayaan, p.207.
- ²² Discussion through e-mail concludes that he believe Indonesian has a set of logical thinking which cannot be explained in western based science.
- ²³ Discussion, after studying Javanese customs and architecture he strongly believes that traditional orders are logical.
- ²⁴ Dakung, op.cit., pp.76-83.
- ²⁵ Hamzuri, op.cit., pp.144-146.
- ²⁶ Dakung, op.cit., pp.183-203.
- ²⁷ Olgyay, op.cit.,p.52.
- ²⁸ Olgyay, op.cit.,p.52.
- ²⁹ Dakung, op.cit., pp.83-86.
- ³⁰ Hamzuri, op.cit., pp.136-140.
- ³¹ Robinette, G.O., 1983, Landscape Planning for Energy Conservation, New York: Van Nostrand Reinhold Company, p.69.
- ³² Olgyay, op.cit.,p.173.
- ³³ Robinette, op.cit, p.102.
- ³⁴ Olgyay, op.cit., p.173.
- ³⁵ Robinette, op.cit, p.102.
- ³⁶ Robinette, op.cit, p.69.
- ³⁷ Olgyay, op.cit.,p.61.
- ³⁸ Lippsmeier, op.cit., p.195.
- ³⁹ Awbi, op.cit., p.25.
- ⁴⁰ Ibid, p.25.
- ⁴¹ Olgyay, op.cit,p.8.
- ⁴² Mukerji, K., Sulejman-Pasic, N., 1975, Prefabrication for Low Cost Housing in Tropical Areas, Starnberg: Institute for Building in the Tropics, p.3.
- ⁴³ Awbi, op.cit., p.23.

-
- ⁴⁴ Awbi, op.cit., p.25.
- ⁴⁵ Olgyay, op.cit., p.173.
- ⁴⁶ Robinette, op.cit, p.192.
- ⁴⁷ Dakung, op.cit., pp.86-92.
- ⁴⁸ Hamzuri, op.cit,pp.3-13.
- ⁴⁹ Dakung, op.cit., pp.123-180.
- ⁵⁰ Mukerji, op.cit., p.26.
- ⁵¹ Dakung, op.cit., p.111.
- ⁵² Drew, op.cit., pp.188-191.
- ⁵³ Lippsmeier, op.cit., pp.60-70.
- ⁵⁴ Prijotomo, op.cit., p.56.
- ⁵⁵ Lippsmeier, op.cit., p.71.
- ⁵⁶ Robinette, op.cit., p.102.
- ⁵⁷ Lippsmeier, op.cit., pp.172-176.
- ⁵⁸ Koenigsberger, 1965, op.cit., p.90
- ⁵⁹ Olgyay, op.cit., p.174.
- ⁶⁰ Olgyay, op.cit., p.173.
- ⁶¹ Mukerji, op.cit, p.5.
- ⁶² Lippsmeier, op.cit., p.179.
- ⁶³ Awbi, op.cit., p.27.
- ⁶⁴ Discussion with Dr. Arya Ronald.
- ⁶⁵ Kukreja, op.cit., pp.95-99.
- ⁶⁶ Boutet, op.cit., pp.85-199.
- ⁶⁷ Mukerji, op.cit., p.3.
- ⁶⁸ Olgyay, loc.cit., p.173.
- ⁶⁹ Olgyay, op.cit., p.174.
- ⁷⁰ Mukerji, op.cit., p.24.
- ⁷¹ Lippsmeier, op.cit., p.73.
- ⁷² Olgyay, op.cit., p.173.

-
- ⁷³ Mukerji, op.cit., p.3.
- ⁷⁴ Olgyay, loc.cit., p.173.
- ⁷⁵ Lippsmeier, op.cit., p.178.
- ⁷⁶ Josef Prijotomo; e-mail of 11 February 1998.
- ⁷⁷ Satwiko, P., 1994, The Development and Modelling of a Natural Ventilation System for Indonesian Condition- case study of a roof chimney, unpublished Master of Building Science thesis, School of Architecture, Victoria University of Wellington.
- ⁷⁸ Awbi, op.cit., p.19.
- ⁷⁹ McIntyre, D.A., 1980, Indoor Climate, Architectural Science Series, London: Applied Science Publisher Ltd.
- ⁸⁰ Watson, D., ed., 1979, Energy Conservation through Building Designs, An Architectural Record Book, New York: McGraw Hill Book Company, p.98.
- ⁸¹ Holm, D., 1983, Energy Conservation in Hot Climate, London: Architectural Press, p.23.
- ⁸² Koenigsberger, op.cit., p.55.
- ⁸³ Koenigsberger, op.cit., p.51.
- ⁸⁴ Berger, X. and Deval, J.C., 1985, About Thermal Comfort in Humid Tropical Climates, in Fanger, P.O., ed., *Clima 2000, Vol. 4: Indoor Climate*, Copenhagen: VVS Kongres - VVS Messe, pp.85-89.
- ⁸⁵ Karyono, T.H., 1995, Thermal Comfort for the Indonesian Workers in Jakarta, Building Research Information, Nov./Dec. 1995, vol.23, no.6, p.317-323.
- ⁸⁶ Department of Public Services of Indonesia, 1990, Technical Guide Proposal for Building Energy Conservation, Workpaper on National Seminar on Building Energy Conservation, Semarang: Universitas Diponegoro.
- ⁸⁷ Awbi, op.cit, p.11.
- ⁸⁸ Lippsmeier, op.cit., p.84.
- ⁸⁹ Ibid.
- ⁹⁰ Ibid.
- ⁹¹ Ibid.
- ⁹² Department of Public Services of Indonesia, 1990, op.cit., p.5.
- ⁹³ Hardjowirogo, M., 1995, Manusia Jawa, Jakarta: PT Gunung Agung, p.7.
- ⁹⁴ Awbi, op.cit., p.3.
- ⁹⁵ Awbi, op.cit., p.5.
- ⁹⁶ ASHRAE Thermal Comfort Program, Version 1.00, 1994-1995, developed by M. Fountain, Environmental Analytics and C. Huizenga, U.C. Berkeley.

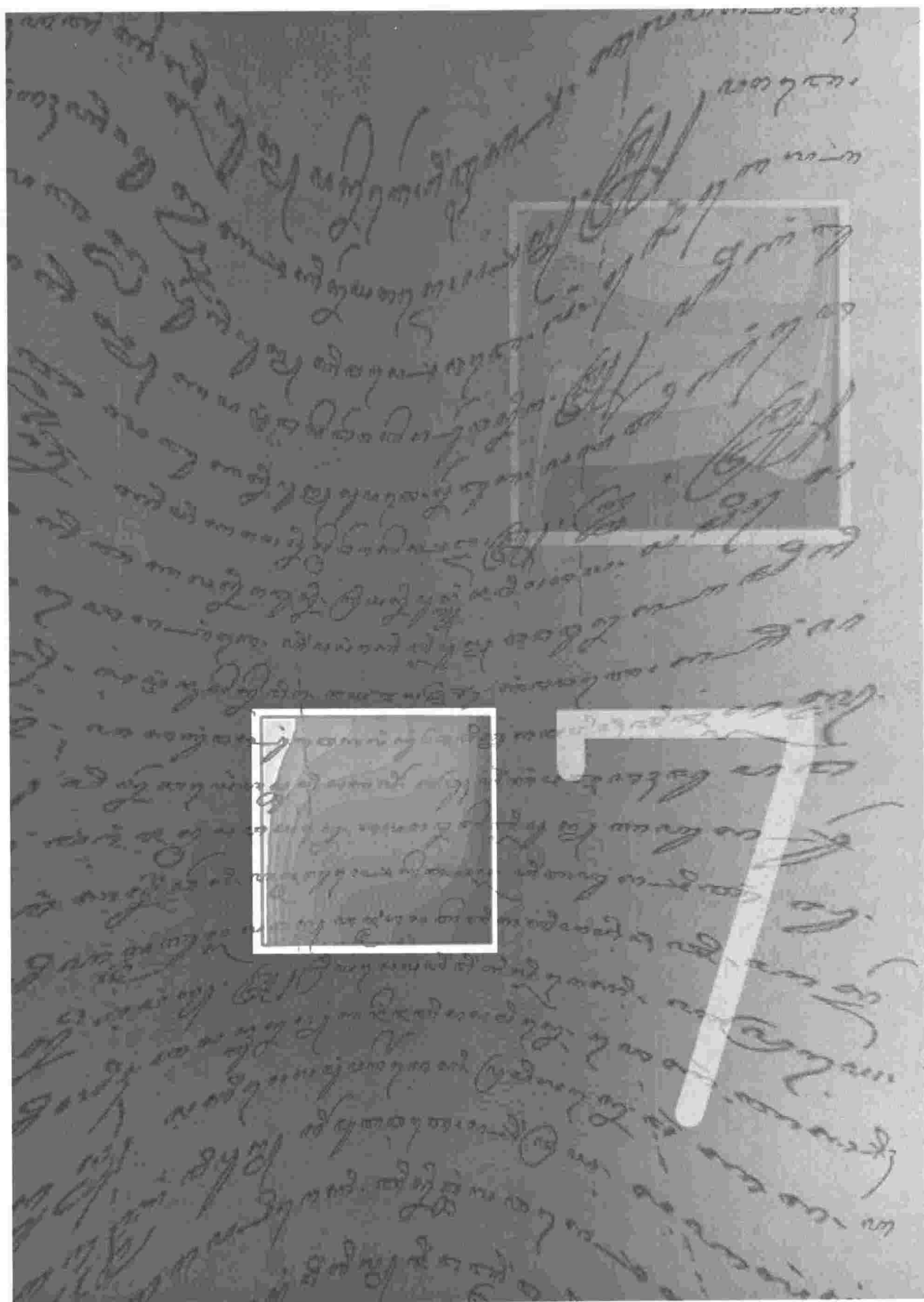

7 • COMPUTATIONAL FLUID DYNAMICS SOFTWARE AND THE INDOOR THERMAL PERFORMANCE OF JAVANESE RESIDENTIAL BUILDING

7.1 Introduction

This chapter discusses the potential of computational fluid dynamics (CFD) software to analyse and predict the indoor thermal performance of residential Javanese buildings. The discussion begins by describing the issues relating to CFD software, particularly in its application to indoor air studies. This informs a subsequent discussion of the nature of indoor thermal comfort performance of residential Javanese buildings. The juxtaposition of these helps anticipate the difficulties in analysing and developing indoor thermal comfort performance using CFD codes. This flows onto CFD program selection, leading to the adoption of a commercial CFD program, CFD-ACE.

7.2 Computational Fluid Dynamics Software – Main Issues

This sub-chapter discusses validation, user-friendliness, and data input. These three issues are highly relevant to the general nature of this research, being conducted by a non-CFD specialist (an architect) to use complicated software (CFD software) in analysing a complex aspect (thermal comfort performance) of an intricate subject (Javanese building).

7.2.1 Validation Issues

As CFD codes results are *not real*, validation becomes a key issue. Subrata Roy defines CFD as:

“The science (and art) of generating numerical solutions to the partial differential equation systems describing fluid motion and heat and mass transport.”¹

P.J. Jones expresses CFD modelling as:

“The process of representing a fluid flow problem by mathematical equations based on the fundamental laws of physics, and solving those equations to predict the variations of the relevant parameters within the flow field.”²

Compared to studies using physical models (such as in a wind tunnel), the results of studies using CFD codes (numerical methods to simulate real conditions) have been regarded with some scepticism. Being *virtual*, CFD codes have been viewed as producing unrealistic results. It has been difficult for these codes to be accepted as imitating real conditions.

CFD was originally developed by L.F. Richardson³, in 1917. Its codes consist of equations, known as Navier-Stokes equations, which are highly non-linear and cannot be solved using simple algebraic methods. As a result, this method has only recently become fully developed, thanks to the new generation of personal computers, which are more powerful, faster, and more economical (on time and labour). These new computers enable experts to solve Navier-Stokes equations iteratively.

CFD methods have several advantages over traditional, analytical and physical model measurement, methods. A CFD model, compared to a full-scale physical model, is easier to set up, less costly, taking less time to run, while simulating boundary layer wind profiles with greater accuracy and ease (having no building size limitations); it is easier to investigate, parametrically, changes in the building's design, and provides valuable output (eg. detailed air flow patterns around the building).⁴ Analytical methods have suffered from severe simplification of assumptions and simplistic designs. Though full-scale physical model measurements provide the most reliable data, they are expensive and difficult (mostly impossible) to do.

Nielsen, in 1974, was the first person who used CFD codes to study air motion in rooms. Since then, experts from various countries have vigorously conducted research on the application of their CFD codes to building environmental studies. Among them are Murakami (Japan)⁵, Awbi (UK)⁶, Li (Australia)⁷, and Baker (US)⁸. However, although it has now been twenty-five years since Nielsen first applied CFD codes to indoor air motion study, issues of validation are still debated. Many research reports have been published, but the majority discuss validating the codes using simple room geometry.

Of thirty-two such papers, three (9.4%) discuss purely theoretical aspects (eg. Baker⁹), sixteen (50%) discuss validation processes (eg. Williams¹⁰), eleven (34.4%) report on the use of CFD codes for practical design purposes (eg. Kolokotroni¹¹), and two (6.2%) report on the use of CFD for actual construction projects (eg. Kent¹²). It seems that experts are still unsure about completely relying on CFD codes as a design tool. Moreover, 80% of the papers present advanced mathematics equations, which require a reasonably high skill level in mathematics for understanding.

CFD solutions are based on the closure of conservation equations relating to mass, momentum, and energy. As the number of unknowns is larger than the number of equations, more equations are needed for closure. Usually, two equations are used, one concerned with turbulent kinetic energy (k) and another relating to kinetic energy dissipation rate (ϵ); these are

popularly known as the k- ϵ equations.

The accuracy of CFD depends very much on the accuracy of the turbulent models. Turbulent modelling express Reynolds stress, turbulent heat flux, and turbulent diffusion flux. The accuracy of an iterative solution depends on such variables as grid resolution (i.e., number of grid points) and convergence criterion used.¹³

From a computational perspective, interior airflows are complex and generally turbulent. Predicting airflow within buildings is more difficult when buoyancy is involved. In terms of the closure the Partial Differential Equations (PDE), buoyancy terms, being non-linear, are the most difficult to handle. Moreover, improper selection of the reference velocity for scenarios involving natural convection in enclosures can cause considerable numerical problems, and hence, inaccuracy.¹⁴ CFD also overestimates flow rates through windows, especially in a buoyancy driven flow. The root of this problem lies in a velocity profile through the opening, not accounted for in the CFD simulation.¹⁵

The k- ϵ model assumes that eddy viscosity is the same for all Reynolds (Re) stress (isotropic eddy viscosity) and is restricted to flows with high Re.¹⁶ This method has been developed and modified. There are still some different opinions about CFD validity based on concerns about the k- ϵ methods used by the codes. Shao states that the k- ϵ model is not suitable for complex flow regimes.¹⁷ Conversely, Li asserts that CFD is capable of predicting the complex airflow and heat transfer problems of buildings for engineering purposes. However, it is important for engineering applications to realise the capabilities and limitations of CFD.¹⁸ He also states that the standard k- ϵ model is not suitable for near-wall turbulence and for free recirculating flows with incompletely developed turbulence.¹⁹ CFD prediction produces detailed information on the distribution of air velocity, temperature, turbulence quantity, contaminant concentration, humidity, and wall surface temperatures, which can be used in airflow design. A study by K.D. Knapmiller²⁰ using a k- ϵ model found this model to be relatively computationally efficient and stable (compared to the more complicated Reynolds stress model) and reasonably accurate for a wide range of turbulent flows. His position is supported by Awbi.²¹

CFD codes (combined with physical modelling) have been used to study the natural ventilation system (large thermal chimney) of the School of Engineering at De Montfort University in Leicester, UK. This is one of the Europe's largest naturally ventilated buildings. Computer simulations were deficient in coping with thermal stratification and the complex internal geometry, which needs a physical model to compensate for missing information.²²

Baskaran and Stathopoulos²³ have studied the influence of computational parameters (the size of the computational domain, number of computational grid nodes, criteria used for the convergence of an iterating process and computing time requirements for different computer systems) on the computed wind loads on the building envelopes. They analysed computed results and computational costs (Central Processing Unit time), concluding thus:

- the number of computational nodes affects the computed result as well as the computational time, more so than the size of the computational domain.
- the error of the unknown pressure field significantly affects the convergence of the iterating process.
- economical computations can be achieved using 32 bit machines with high clock speed.

CFD codes (commercial and non-commercial) offer many advantages in the simulation of air motion. However, it is necessary to quantitatively validate them against high quality experimental data. Roy²⁴ (using FLUENT) comments that the accuracy of CFD algorithms and code must first be validated and tested against benchmark analytical and computational solutions to assess the numerical error mechanisms that can compromise their accuracy. Then, a set of experiments can be conducted for a practical problem with parametric variation in the balance of diffusive and convective mass transport processes. Validation against wind tunnel data is preferred to real measurements as the latter suffers from uncertainties that compromise data accuracy. Kent²⁵ (using FLOVENT) states that even though absolute accuracy cannot be claimed, the predictions give invaluable insight into airflow patterns velocities, temperature and humidity throughout a building.

The benefits of numerical methods are usually discussed and compared in terms of the solution's accuracy and computational efficiency (computational time and memory requirements). The standard k- ϵ model is by far most popular, though not the most accurate. Large Eddy Simulation is heralded as potentially the best (more accurate), but is currently under further development. The problem with this model is that it still suffers time and memory space inefficiency.

For a given grid, Finite Element Methods (FEM) are more accurate than Finite Volume Methods (FVM), but they are also more complex, requiring more CPU time and memory. Reynolds stress models are more intricate than the k- ϵ model and require significantly more powerful computers. This may limit their practical applications to design.²⁶

According to Baker, since all CFD procedures constitute the union of a significant

number of assumptions, it is unreasonable to expect the results of a given CFD simulation to be accurate unless the problem definition is limited and care is exercised in design and execution of the CFD experiment.²⁷ Baker states that all CFD theories, whether finite difference method (FDM), finite volume method (FVM), finite element method (FEM), or any others are limited to the establishment of an approximation to the genuine Reynold averaged Navier-Stokes solution (RaNS).

Li summarises the major challenges to the application of CFD in indoor airflow: modelling the physics of the flow (including turbulence), specifying realistic boundary conditions, representing the complex geometry of the room, and developing accurate and efficient numerical algorithms.²⁸

7.2.2 User-friendliness Issues

User-friendliness is one of the most important CFD characteristics sought by non-CFD specialist users, such as architects and building designers. Li regards CFD as an integrated scientific discipline, bringing together different disciplines such as engineering, fluid mechanics, mathematics, computer science, computer graphics, and computational geometric.²⁹ Figure 7-1 describes Li's model of CFD as interdisciplinary exercise. There is no obvious place for architects. CFD might seem to be a field beyond the general architects' knowledge, to their exclusion. However, architects such as Murakami, Aynsley, and Arens are well-known for their contribution to architectural aerodynamics, indicating the ability of some architects to work within this field.

Developing CFD codes for application in building design without involving architects at some stage will result in a discrepancy between architects' needs and the codes. Architects value artistic design components (proportion, geometry, material, etc.) higher than engineering considerations. Regarding CFD, in 1984, Shibley had anticipated the tendency of programmers to overemphasise numerical and computation aspects to the detriment of architectural aspects:

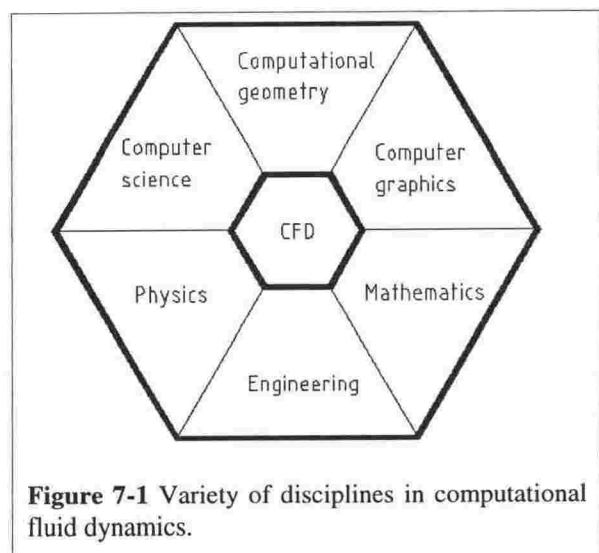

Figure 7-1 Variety of disciplines in computational fluid dynamics.

“The simulations of building performance based on complex computer codes

can inform the architects of trade-offs during design, but the development of the probability models and computer codes falls more closely into the categories of statistics and computer science than architecture.”³⁰

Most commercial CFD codes are general purpose, though companies claim their codes have the ability to simulate thermal performance of buildings. Some commercial CFD codes designed for airflow inside and around buildings are: VORTEX-2, FLAIR, FLUENT, and FLOVENT. Further, individual experts (eg. Li, Awbi, Murakami, and Nobile) have developed their own codes especially for air motions.

User-friendly programs should provide for interactive input, instant error checking, on-line help, random access inputs, and few and simply organised levels.³¹ For ease of use, current software competes to offer an advanced Graphics User Interface (GUI), making the complicated software seem easier. Requirements for accuracy, speed, and flexibility can conflict with ease of use. Simpler to use means harder to program.³²

Ease of use involves more than speed and user-friendliness. The computer program should provide the user with intelligent alternative answers.³³ Ideally, to use CFD codes with confidence an architect should have a reasonable background in that field. This proves difficult, as architectural education does not commonly involve high numerical or mathematical studies. Thus, architects require another parameter for software user-friendliness: an inherent ability for the software to assess results autonomously (eg. against set benchmarks) and warn the user of any bias. Emphasis placed on computer-aided architectural design must therefore be on the needs of the designer (on the design and design methods) rather than of the computer.³⁴

In design, making decision based on one aspects to the detriment of the others has very limited usefulness, and is sometimes misleading.³⁵ Architects might need flexible codes, which can give them scope to deal with comprehensive design without being too dependent on the external assistance of CFD experts. Cheng states that it may take three to six months for an engineer familiar with general concepts of computer modelling of fluid flow processes to become sufficiently familiar with a well-developed computer code to apply it with confidence.³⁶ Current architectural education does not seem to offer a good base for architects to easily understand CFD codes. User-friendly CFD codes will help architects to confidently use the advanced numerical methods in design process without having to be worried about the numerical sciences.

Computer-based design methods are categorised within one of three types of concept:

simulation concepts, generation concepts and optimisation concepts.³⁷ Present CFD codes for building environmental designs fall into first category; architects can use them to check any environmental consequence of their design. CFD codes are operated by trial and error. Whether these codes are ideal for decision making in the architectural design process can probably be determined from the information they provide. Radford suggests the information requirements to make this decision:³⁸

- *A designer needs manipulative models that can be used to explore the relationship between design decisions and performance results.*
- *The information derived from such models should be concerned with fields of solutions.*
- *The information should explicate the trade-offs involved in design, in order to clearly determine the losses from one group of design goals if performance is advanced in another group.*

Fazio writes:

“Architectural and building design problems are radically different from other domains because of the subjective nature of space planning, and selection of materials and systems that are knowledge intensive, project specific, and involve little computation.

“... Successful performance of an envelope assembly depends on the judicious selection of materials and constructional systems to meet the various functional and user requirement of building: thermal resistance, moisture protection, structural strength, cost, buildability, maintainability.”³⁹

The current status of CFD codes development in relation to building environmental design might be indicated by Kindangen who suggests that numerical simulation of 3-D turbulence in a building by means of a k- ϵ model corresponds closely to experimental results.⁴⁰ However, it is not generally or easily applied at the design stage; CFD codes are complicated and require some considerable experience for trustworthy results. Further research is required to find a more practical design tool. Kindangen used commercial software STAR-CD. Yamamoto, Ensor and Sparks developed a user-friendly ventilation model solver as a CFD tool for engineers lacking knowledge of CFD.⁴¹ Their codes require less computation time compared to commercial CFD codes such as FLUENT.

7.2.3 Data Input Issues

Li lists the factors governing airflow:⁴²

- room geometry
- type and location of the supply air terminal and the location of the extract air terminal
- supply air parameters: velocity, momentum flux, buoyancy flux
- location, shape, and buoyancy flux of heat sources
- location of obstacles and furniture
- radiation and heat loss through the walls
- infiltration and exfiltration
- movements of obstacles and furniture

The accuracy of the solution will also depend on accuracy in specifying the physical quantities at the boundary of the flow domain and on the methods of linking these quantities to the bulk of flow.⁴³ The successful application of CFD in HVAC depends on how well the performance model is integrated.⁴⁴ Thus, the users' ability to translate parameters (model and air properties) and their interrelationships into computer data input is a highly crucial step towards realistic results. Unfortunately, it seems difficult for users who do not have a reasonable background in aerodynamics (or fluid flow) and heat transfer to be certain their steps are correct. Thus, for detailed and highly accurate results, assistance from another discipline should be sought. However, for engineers who are only interested in averaged quantities, some of the available models have produced very good results.⁴⁵

Li strongly states that the success of the application will not only depend on the quality of the codes, but also on the users. Although some of the available CFD codes furnish a good user-interface, there is no substitute for knowledge of CFD and experience in running CFD codes.⁴⁶ Li recommends the following steps to test the accuracy and efficiency of a simulation:⁴⁷

- comparison of code with exact solutions for simple problems
- comparison of code with benchmark simulations or another code with different numerical methods that solve the same equations
- convergence history and spatial resolution analysis
- comparison of code with measurements

However, using research results (or other standards) should be done with care. Chen proposes the use of interpolation theory in error reduction.⁴⁸

7.3 Indoor Thermal Comfort Performance of Javanese Residential Building and CFD Codes

This section discusses the nature of indoor thermal comfort performance in relation to residential Javanese buildings vis-à-vis computer codes, or more specifically, CFD codes.

7.3.1 Effect of Building Forms

As Chapter Six discussed, the forms of Javanese buildings might contribute to their indoor thermal comfort performance. In detail, any discussions involving form will include overall geometry, detailing, dimension, and proportion. For example, walls in traditional abodes are not made from thin sheet materials (though woven bamboo sheets can be considered as thin sheets), which is how walls are represented in the computer simulation. Boutet, however, writes:

*“The planes of an interior space such as walls which determine the length, depth, and height of the space are relatively two-dimensional. The thickness of these planes is basically insignificant with regard to air movement control. Therefore, the control of air movement is achieved from the volumetric relationship of the planes - the shape of the space.”*⁴⁹

He clearly indicates geometry as a key element.⁵⁰

Studying the effects of Javanese forms on their indoor thermal performance using CFD codes requires a lot of careful thought -particularly if one firmly believes that Javanese architects developed their designs (ie. environmental design) by a different approach to their western counterparts. There remains the possibility of a well-hidden concept of Javanese architecture having been overlooked. The detailed discussion in Chapter Six was intended to reduce this risk.

To copy the real form exactly and precisely into a model is a very poor strategy. Logically, this should give the most realistic simulation, albeit at the cost of considerable labour and computing time, as well as computer memory. Current friendlier graphic user interface and computer technology might eliminate these issues. Still, the question of whether current CFD codes can handle highly complicated models remains. Preliminary experiments showed more complicated forms incur greater problems.

7.3.2 Effect of Material Properties

Material property conversion might also be a potential problem. As mentioned in Chapter Five, Javanese buildings utilised various local materials, traditionally made and prepared. Focusing on the hand-made technologies, complicated ceremonies, and calculations when preparing building materials, might hide brilliant considerations, generating superb building performance

(environmentally and structurally). The properties of these unique materials have not been scientifically measured. Neither western nor Indonesian references have studied any properties (conductivity, heat capacity, porosity, absorptivity, etc.) of these materials. For example, data on the properties of traditionally made clay tiles (for roof covers) and woven bamboo (for walls), is not to be found.

Difficulty in supplying correct material properties for input data could result in erroneous calculations. This is the most significant concern in a study of the effect of Javanese building materials on indoor thermal comfort performance. If a highly accurate result is required, there appears no substitute for conducting some small experiments to obtain those material properties. Another way to approach this problem is by interpolation and calculation using available material data such as those found in the ASHRAE and CIBSE Handbooks. Knowing the average thickness of clay tiles, for example, their conductance can be calculated based on data found in literature. However, this ignores the influence of the traditional hand made technology (the way people mix, burn, and cast the clay tiles, for example) on the material properties (conductivity, density, etc.).

7.4 Expected Difficulties in Analysing and Developing Indoor Thermal Comfort using Computational Fluid Dynamics Software

With all the capabilities offered by CFD codes, analysing and developing indoor thermal comfort should be less difficult. In only one execution, CFD codes can produce abundant information on variables (such as pressure, temperature, velocity and density) with high precision. These variables can be combined to generate other variables (such as humidity). Difficulties are expected when running both airflow and thermal problems simultaneously (as both should act together to create a certain quality of indoor atmosphere).

7.4.1 Architects and Building Environmental Designs

Architects' satisfaction with CFD results might depend on the stage of their design. Sonderegger tabulates CFD as a design tool:

Table 7-1 Performance criteria of design tool at different stages of design.⁵¹

Design stage	Speed	Accuracy	Versatility
Conceptual design	H	L	M
Design development	M	M	H
Construction plan	L	H	H

H = high, M = Medium, L = Low.

During conceptual design, speed is the priority, followed by versatility and accuracy of the program. At the design development stage, versatility of the program becomes a priority. During construction, accuracy and versatility are prioritised.

Wiesel states that an ideal (rational) process of building design should be guided by results from the performance evaluation of the generated solutions.⁵² If architects want to use CFD codes in their design process, they might need codes that support computer aided design systems. Kalay indicates the potential value of including CFD codes within computer aided design systems; CAD systems can assist designers in two ways:

- By fully modelling the artefact being designed and automatically maintaining the semantic integrity of the model.
- Guiding the designer through the planning process and providing him/her with informative feedback on design decisions.⁵³

Manning emphasises that:

*“An unavoidable first step toward computer-aided design of buildings must be a greater employment of rationality and system in the field of building design, which traditionally has been more generally associated with artistry and individuality.”*⁵⁴

Li feels that an ideal design of HVAC is impossible because architectural design and the functional requirements of the building override thermal comfort and indoor air quality requirements. Thus, a trade-off design is preferred. CFD codes could help evaluate different possibilities simply by changing input parameters.⁵⁵

The application of CFD in building ventilation design (particularly in its ability to provide very detailed information which is unobtainable by other means) has raised two questions: Is the full potential of CFD (in producing very detailed and precise results) achievable in building design? Is such detail necessary? Etheridge and Sandberg suggest the full potential unattainable, as designers almost always face uncertainties in specification of boundary conditions. The necessity of detail depends on the particular circumstances of each building.⁵⁶ The strengths and weaknesses of CFD are compared in Table 7-2.

7.4.2 Converting Real Building Data into Computer Input Data

Converting real building data into computer data is a first and crucial step. It defines how the computer constructs the model, transforming physical phenomena (the *real* world) into numbers

(the *virtual* world of computers). In sub-chapter 7.2.3, Li lists the factors governing airflow. It clearly reveals the data required to simulate airflow. First listed is the room's geometry. Appearing simple, it quickly becomes complicated if one is concerned with the degree of *reality*; the reduction of discrepancies between computer modelling and reality.

A popular tactic is to carry out some degree of simplification. Almost all building computer modelling is a simplification of the real building. Practically, experts in this field (building environmental design, architects, etc.) tend to only need a rough idea of the airflows within and around buildings, especially at the preliminary design stage. There is thus no need of extreme precision. Moreover, the nature of airflow within and around buildings is full of change and fluctuation. There is no single steady state simulation that can accurately represent real airflows in this situation (except for laboratories where precise airflow is sometimes required). This is not the case in mechanical engineering (machinery) where everything should be very precise.

Table 7-2 Strength and weaknesses of CFD.

Property	CFD	Full scale	Model scale	Simple methods
Continuum	No	Yes	Yes	No
Geometric similarity	Approx.	Yes	Approx.	Approx.
Size limitations	No	Yes	Some	No
Scale effects	Some	Moderate	Yes	Yes
Instantaneous turbulence	Indirectly	Yes	Yes	No
Hazardous events	Yes	Limited	Limited	Yes
Modelling of moving people	Limited	Yes	Limited	Limited
Empirical content	Some	None	Little	High
Potential accuracy	High	High	Moderate	Low
Tuning required for highest accuracy	Yes	No	No	No
Capital cost	Moderate	High	Moderate	Low
Running cost	High	High	High	Low
Experienced user desirable	Yes	No	No	Yes
Useable at design stage	Yes	No	Yes	Yes

Simplification means reduction in detail. This usually involves ignoring complicated detailed design, making assumptions (reducing the unknowns by assuming them rather than making sub calculations), and minimising variables. This is the critical trade-off between simple modelling and accurate simulation. One might conclude that the optimum trade-off depends on how well one understands the essence of a phenomenon and its conversion to computer language. Thus, there are two things to be understood: the resultant effects of action on the part of the phenomena (two or three individual phenomena might produce a combined effect) and how computer codes use that data. Clearly, simplification should be applied carefully in experiments studying the effect of details (geometry, material properties, etc.) on, for example, airflow.

7.4.3 Program Sensitivity

Program sensitivity is an important issue. Ideally, a highly sensitive program is needed in the exploration of Javanese building environmental design. Factors considered might include how any changes (whether minor or major) in design aspects (ie. forms and materials), affect indoor thermal comfort parameters (air temperature, humidity, etc.). This requires codes, in this case CFD codes, which are sensitive to those changes. Their sensitivity depends on many factors, including the codes themselves (advanced mathematical modelling) and the way they operate (strategy in forming the grid, and transposing data to computer input).

CFD code users who are not experts in fluid dynamics (such as architects or building scientists) might mainly depend on their ability to construct a grid and translate data into computer input to get the best results from the program. They might leave the flow solver untouched, and use default settings. It is thus important that the programs give their best performance at the default setting in anticipation of non-fluid dynamics expert users.

Computational fluid dynamics are still being progressively developed throughout the world to obtain better results. The friendlier graphic user interfaces offered by later commercial CFD codes have improved the access of users to the versatility of the codes. A more sophisticated CFD code does not necessarily require greater expertise in operation. However, the codes still need a lot of information in order to recognise any changes in the model. From the user's viewpoint, this requires strategy in focusing the grid and translating the data. Preliminary study showed that bad grid design might result in the loss of program sensitivity.

7.5 Program Selection

From the discussion above a list of criteria to select a CFD program for this experiment can be condensed as follows:

- Ability to simulate building aerodynamics and heat transfer, both internally and externally.
- Produce reliable results.
- Sensitive to model changes.
- User-friendly.
- Runs in a standard computer platform.
- Produces results which are easy to interpret.

Another important criterion is the price. The available commercial multi-purpose CFD programs are designed to be user-friendly in order to anticipate more general users. These programs, offered in annual or perpetual licenses, are relatively expensive for non-commercial experiments, such as this present study. Very few programs offer a cheaper research license.

7.6 The CFD-ACE Program

In this experiment a commercial CFD program, CFD-ACE version 4, was used. This multi-purpose program was created by the CFD Research Corporation. It meets most of the criteria required for this experiment (see the discussion above) including user-friendliness and reliability in simulating building aerodynamics and heat; it requires a relatively basic computer platform, and has advanced graphics presentation. Another crucial factor is that it offers a relatively low research license fee, which is the lowest of available CFD codes.

CFD Research Corporation produces CFD codes with three separated modules. The first, CFD-GEOM (version 4.0.8.6), is used to construct the computer model from geometry and boundary condition to grid design. It has the capability to construct both structured and unstructured grids. The second module, CFD-ACE (also called CFD-GUI version 4.0.7), is the flow solver. CFD-ACE version 4 cannot work with an unstructured grid, but version 5 can. (This experiment did not use version 5, as it was not released until the experiment programme was almost completed.) The third module is CFD-VIEW (version 4.0.69), which functions as a powerful post-processor. It makes the results of CFD-ACE readable and enjoyable. CFD-VIEW can graphically present and animate the results of CFD-ACE.

7.7 Summary

- Though under continuous development, Computational Fluid Dynamics (CFD) programs are promising tools for research in building environmental performance simulation.
- CFD programs offer some superiority (such as less initial and labour costs, less time consumption, and more detailed and various results) over wind tunnel and mathematical modelling.
- A CFD program should be calibrated and validated before using it confidently.
- The k- ϵ turbulent model gives a reasonable simulation of building aerodynamic and thermal performance.
- Flow domain definitions, boundary condition definitions, geometry definitions, grid design strategy, and CFD program sensitivity are crucial in obtaining good results.
- CFD programs are promising tools to simulate the indoor thermal comfort performance of Javanese buildings. To avoid the loss of important thermal comfort related features of Javanese building design, careful transformation of the real building data to computer models should be ensured.

The following chapter (Chapter Eight) will discuss the CFD program calibration, in order to use it confidently in the experiments.

Endnotes

- ¹ Roy, S., Kelso, R.M., Baker, A.J., An Efficient CFD Algorithm for the Prediction of Contaminant Dispersion in Room Air Motion, ASHRAE Transaction, vol.100, part 2, pp.980-987.
- ² Jones, P.J., Whittle, G.E., Computational Fluid Dynamics for Building Air Flow Prediction - Current Status and Capabilities, Building and Environment, vol.27 (1992), no.3, pp. 321-338.
- ³ Roache, P.J., 1976, Computational Fluid Dynamics, New Mexico: Hermosa Publisher.
- ⁴ Shao, L., Sharples, S., Ward, I.C., Building Pressure Coefficient: Application of Three-dimensional CFD Methods to Prediction, Building Service Engineering Research Technology, vol.13 (1992), no.2, pp.107-111.
- ⁵ Murakami, S., Kato, S., Ooka, R., Comparisons of Numerical Predictions of Horizontal Non-isothermal Jet in a Room with Three Turbulence Models k-ε EVM, ASM, and DSM, ASHRAE Transaction, vol.100, part 2, pp. 697-704.
- ⁶ Awbi, H.B., 1991, Ventilation of Buildings, London: Chapman and Hall.
- ⁷ Li, Y., 1994, The Role of Computational Fluid Dynamics in Air Flow Design within Buildings, in Proceedings of Third CIBSE Conference, February 15-18, 1994, Melbourne, Australia.
- ⁸ Baker, A.J., Williams, P.T., and Kelso, R.M., 1995, Numerical Calculation of Room Air Motion-Part 3: Three-Dimensional CFD Simulation of a Full-Scale Room Air Experiment, ASHRAE Transaction, vol.100, part 2.
- ⁹ Baker, A.J., Williams, P.T., and Kelso, R.M., 1995, Numerical Calculation of Room Air Motion-Part 1: Math, Physics, and CFD Modeling, ASHRAE Transaction, vol.100, part 2, pp. 514-530.
- ¹⁰ Williams, P.T., Baker, A.J., Kelso, R.M., 1996, Numerical Calculation of Room Air Motion - Part 3: Three-Dimensional CFD Simulation of a Full-Scale Room Air Experiment, in ASHRAE Transactions, vol.100, part 2, pp.549-564.
- ¹¹ Kolokotroni, M., Saiz, N., Littler, J., Moisture Movement: a Study Using Tracer Gas Techniques and CFD Modelling, vol.13 (1992), no.2, pp.113-117.
- ¹² Kent, J.H., Air Conditioning Modelling by Computational Fluid Dynamics, Architectural Science Review, vol.37 (1994), no.3, pp.103-113.
- ¹³ Awbi, op.cit., p.230.
- ¹⁴ Williams, P.T., Baker, A.J., 1996, CFD Characterisation of Natural Convection in a Two-Cell Enclosure with a door, in ASHRAE Transactions, vol.100, part 2, p.688.
- ¹⁵ Awbi, op.cit., p.246.
- ¹⁶ Li, loc.cit., pp. Li-1-Li-15.
- ¹⁷ Shao, L., Sharples, S., Ward, I.C., Building Pressure Coefficient: Application of Three-dimensional CFD Methods to Prediction, Building Service Engineering Research Technology, vol.13 (1992), no.2, pp.107-111.
- ¹⁸ Li, loc.cit., p.13.
- ¹⁹ Li, loc.cit., pp. Li-1-Li-15.
- ²⁰ Knappmiller, K.D., Computational Determination of the Behaviour of a Cold Air Ceiling Jet in a Room

with a Plume, ASHRAE Transaction, vol.100, part 2, pp.677-696.

²¹ Awbi, op.cit., p. 219.

²² -----, 1993, Building Services Reports: Will Natural Ventilation Work?, Building Services, (1993), pp.41-42.

²³ Baskaran, A., Stathopoulos, T., Influence of Computational Parameters on the Evaluation of Wind Effects on the Building Envelope, Building and Environment, vol.27 (1992), no.1., pp.39-49.

²⁴ Roy, et al., loc.cit., pp.980-987.

²⁵ Kent, loc.cit., pp.103-113.

²⁶ Chen, Q., Prediction of Room Air Motion by Reynolds-Stress Models, Building and Environment, vol.31 (1996), no.3, pp.233-244.

²⁷ Baker, et al.,

²⁸ Li, Y., General Flow and Thermal Boundary Conditions in Indoor Air Flow Simulation, Building and Environment, vol.29 (1994), no.3, pp.275-281.

²⁹ Li, Y., The Role of Computational Fluid Dynamics in Air Flow Design within Buildings, , pp. Li-1-Li-15.

³⁰ Shibley, R.G., 1984, Quads and Quality: Architectural Inquiry about Energy in Snyder, J.C., ed., 1984, *Architectural Research*, New York : Van Nostrand Reinhold, p.219.

³¹ Sanderegger, R.C., 1985, Thermal Modelling of Building as a Design Tool, in Fanger, P.O., ed., *Clima 2000: Voll: Future Perspective*, Copenhagen: VVS Kongres - VVS Messe, p.73.

³² Ibid, p.70.

³³ Ibid, p.73.

³⁴ Radford, A.D. and Gero, J.S., 1988, Design by Optimisation in Architecture, Building and Construction, New York: Van Nostrand Reinhold Company, p.1.

³⁵ Radford, op.cit, p.10.

³⁶ Chen, Q., Suter, P., Moser, A., Interpolation Theory and Influence of Boundary Conditions on Room Air Diffusion, Building and Environment, vol.26 (1991), no.4, pp.433-445.

³⁷ Radford, et al., op.cit.,p.xiii.

³⁸ Radford, et al., op.cit, p.25.

³⁹ Fazio, P., Bedard, C. and Gowri, K., 1992, Constraint for Generating Building Envelope Design Alternatives, in Kalay, Y.E., ed., 1992, *Principles of Computer-Aided Design: Evaluating and Predicting Design Performance*, New York: A Wiley-Interscience Publication - John Wiley and Sons, Inc., p.146.

⁴⁰ Kindangen, J. and Krauss, G., Investigation of Natural Ventilation with Computational Fluid Dynamics, a Comparison Study with Wind Tunnel Results, Architecture Science Review, vol.39 (1996), no.1, p.113-120.

⁴¹ Yamamoto, T., Ensor, D.S., Sparks, L.E., Evaluation of Ventilation Performance for Indoor Space, Building and Environment, vol.29 (1994), no.3, pp.291-296.

-
- ⁴² Li, op.cit., pp. Li-1-Li-15.
- ⁴³ Awbi, H.B., 1991, Ventilation of Buildings, London: Chapman and Hall, p.230.
- ⁴⁴ Li, op.cit., pp. Li-1-Li-15.
- ⁴⁵ Li, o.cit., pp. Li-1-Li-15.,p.3.
- ⁴⁶ Li, op.cit., pp. Li-1-Li-15.
- ⁴⁷ Li, op.cit., pp. Li-1-Li-15., p.13.
- ⁴⁸ Interpolation theory, according to Qin Yen Cheng, is the art of deducing useful information for a specific design from databases or cases available in publications.
- ⁴⁹ Boutet, T.S., 1987, Controlling Air Movement: A Manual for Architects and Builders, New York: Mc Graw Hill, p153.
- ⁵⁰ Ibid., p.152.
- ⁵¹ Sanderegger, op.cit., p.72.
- ⁵² Wiesel, A., and Becker, R., Integration of Performance Evaluation in Computer-Aided Design, in in Kalay, Y.E., ed., 1992, *Principles of Computer-Aided Design: Evaluating and Predicting Design Performance*, New York: A Wiley-Interscience Publication - John Wiley and Sons, Inc., p.171.
- ⁵³ Kalay, Y.E., ed., 1992, *Principles of Computer-Aided Design: Evaluating and Predicting Design Performance*, New York: A Wiley-Interscience Publication - John Wiley and Sons, Inc., p.26.
- ⁵⁴ Manning, P., and Mattar, S., A Preliminary to Development of Expert Systems for Total Design of Entire Buildings, in Kalay, Y.E., ed., 1992, *Principles of Computer-Aided Design: Evaluating and Predicting Design Performance*, New York: A Wiley-Interscience Publication - John Wiley and Sons, Inc., p.218.
- ⁵⁵ Li, loc.cit, pp. Li-1-Li-15.
- ⁵⁶ Etheridge, D., Sandberg, M., 1996, Building Ventilation: Theory and Measurement, Chichester: John Wiley and Sons, p.701.



8. CALIBRATION OF THE EXPERIMENTAL TOOLS – THE PHYSICAL AND COMPUTER MODELS

8.1 Introduction

This chapter discusses experiments conducted for calibration, so the CFD program may be used confidently as the tool of the main experiment. It is intended to set up a strong base for the main experiment, discussed in Chapters Nine and Ten.

Two calibration exercises should be conducted to determine the performance of the software in dealing with aerodynamic and heat transfer (thermal) problems. Ideally, these should be done simultaneously so that a realistic scenario can be simulated. However, to isolate the observation (as well as to reduce the complexity of the modelling), procedures were divided into two experiments: calibration of the aerodynamic solution capability and of the thermal solution capability.

Understanding thermal comfort parameters, and the effect of building aerodynamics and heat transfer on them is important in building *realistic* computer models. It helps the researcher focus on to the relevant factors and predict sensitive points. Constructing a computer model can be understood as transposing the physical (*real*) model into a digital (*unreal*) model. Being *non-corporeal* it has no practical limitation. For example, one could easily construct a model of a building in an environment without any gravitation or atmosphere.

The computer model simulation defines values at points in a virtual space (computer). One advantage is an ability to select only the relevant factors for any specific case. Meanwhile, a good prediction of sensitive points is useful restricting observation to positions where *interesting* phenomena occur. Selecting relevant factors and sensitive points will result in efficient calculation.

This research involves three main objects: humans (who feel the sensation of thermal comfort), buildings (the barrier between indoor and outdoor atmosphere) and the atmosphere (the medium). In thermal comfort terms, their interrelationship is governed through two mechanisms: aerodynamics and heat transfer. Table 6.4, *The Prediction of the Influence of Javanese Architecture Orders to Indoor Thermal Comfort*, describes those interrelationships.

A building is an envelope which, either partially or wholly, separates outdoor from indoor atmosphere. It determines how the outdoor atmosphere affects the indoor atmosphere. Good building environmental design can tame the wild outdoor atmosphere to create pleasant interior conditions. Conversely, poor design can turn a building situated in a naturally tranquillising location into an unbearable place to live.

Aerodynamics and heat transfer work together to create certain indoor atmospheric conditions. Air flows according to rules of aerodynamics, which are further governed by heat transfer (thermal) processes.¹ In buildings, air not only flows because of pressure differences, but also because of the stack effect.

In this research, six thermal comfort parameters and airflow patterns are studied: air temperature (T), air velocity (V), air relative humidity (RH), mean radiant temperature of surrounding surfaces (MRT), metabolic rate (met), and clothing value (clo). Other parameters such as race, sex, and age are not considered in detail. The airflow pattern is included in the study because it is important to understand how a building's form affects air circulation, particularly within occupants' zones. To avoid too many variables, some of them are assumed constant.

Building designs affect aerodynamics and heat transfer in complex ways. However, even though aerodynamics and heat transfer should not be discussed separately, they have their own sensitivity to building design features. The former is more sensitive to building form (shape and detail) whereas the latter is more sensitive to building material properties (density, specific heat, and conductivity).

8.2 Experiment for Aerodynamic Calibration

The following sub-chapter discusses in detail the experiment for aerodynamic calibration.

8.2.1 Data of Building and Wind Tunnel Model

The Texas Technology experimental building^{2,3} (Wind Engineering Research Field Laboratory, Department of Civil Engineering, Texas Tech University, Lubbock, Texas) was chosen as a case study. The main consideration was the availability of existing data. Reports on research projects using this building as their case study are published in the Journal of Wind Engineering, which include field data, wind tunnel modelling^{4,5}, and computer modelling.⁶ A 1:25 scaled model of this building has also been tested in a wind tunnel at the Opus International Consultants' Laboratory (Lower Hutt, New Zealand), providing essential data for comparison.

Data of Texas Tech experimental building:

- location: Texas Tech University, Lubbock
- building dimensions: 30 x 45 x 13 ft (9.2m wide x 13.7m long x 4m high)
- structure: prefabricated metal, can be rotated 360°
- taps: 114 points

Data of the 1:25 scaled model of Texas Tech. Experimental building by Opus International Laboratory:

- wind tunnel: 1.27m high x 2.7m wide, with a blockage tolerant type ceiling. The test section is 4.8m long, and the model located half way along the test section.
- model dimensions: 369mm wide x 552mm long x 156mm high
- structure: plastic, can be rotated 360°
- taps: 15 points

8.2.2 Experiment Preparation

To calibrate the CFD-ACE program, results from wind tunnel experiments and other CFD codes were compared. In this experiment, the CFD modelling is given a detailed explanation, while wind tunnel modelling is only briefly discussed.

Two limitations have been set up for the experiment:

- the calibration seeks to find the best performance of the CFD-ACE in the hands of a person who understands fluid dynamics, but not the equations used to represent it. No modification is to be made to the CFD codes.
- the experiment is focused on the pressure coefficient of windward and leeward surfaces of the Texas Tech. Building. This experimental building is ideal, given the volume of published data readily available.

The Texas Tech. Experimental building field data was used by some to verify the wind tunnel experiments (such those conducted by Surry⁷, and Cochran and Cermak⁸). Another expert, Selvam,⁹ uses the field data to verify his wind tunnel experiment and computational fluid dynamic simulation. This experiment uses four sets of data as references: field data, Selvam's wind tunnel, Selvam's computational fluid dynamic, and the Opus wind tunnel (1:25 model). The field data, describing the real condition of the real building, is used as the main reference. The other three references are used for comparison

8.2.2.1 Wind Tunnel Experiment

The main concerns in any wind tunnel tests are the effect of scaling and *squeezing*. However, extensive studies in this area have proved reliable results can be produced by wind tunnel testing.

8.2.2.2 CFD Experiment

The CFD experiment has three main steps: grid definition (virtual model construction), flow solution (flow simulation), and result presentation (result evaluation). These three main steps are cyclic rather than strictly linear.

The first step in the experiment using CFD codes is to construct the building and its environment, including grid and boundary definition. Data required at this stage includes:

- dimensions of the building,
- geometry of the building,
- direction of air flow (which define the position of boundary conditions for inlets and outlets), and
- types of surfaces (which define the boundary conditions for walls)

Given that this experiment does not study the airflow inside the building, it can be defined as a block. Unlike the wind tunnel experiment, with CFD codes the building can be modelled full-scale, without any difficulty.

To obtain better labour and processing time as well as disk space and memory efficiency, recommended strategies from manuals and references are used. The first strategy is to make the preliminary model as simple as possible before advancing to something more complex. The process can be summarised thus:

- **2D model of building basic geometry.** Two-dimensional modelling of basic building geometry saves a great deal of disk space and Random Access Memory (RAM) while offering faster solutions than 3D models. It is, however, not fully recommended to simulate air flows within and around building as they are usually three dimensional. For a symmetrical problem, only a half model is required.
- **2D model of building with some added details.** Airflows are affected by details. However, not all details are usefully considered. As details significantly increase the difficulty of the flow solution, they should be applied carefully. Details which do not significantly effect the flow are wisely ignored.
- **Half-full scale 3D model.** Some models are symmetrical in one or more axes. The model can thus be made in half, instead of in full, which will considerably reduce the computing time

and disk space required.

- **Whole-full scale 3D model.** Three-dimensional modelling is useful in simulation of a near realistic flow, as the air moves in any direction. This model is useful when a half-full scale model cannot be used (e.g. For a non-symmetrical model, or for a symmetrical model where the airflow direction does not align to the symmetrical axis of the model).
- **Uniform low grid resolution.** Low grid resolutions save much memory and offer a faster solution. They are usually sufficient to get a rough idea of the flows.
- **Non-uniform low grid resolution.** In a non-uniform low grid resolution a finer grid can be concentrated at critical locations such as inlets, outlets, and walls (or any places where highly fluctuated flow might occur) without necessarily increasing the grid resolution. This is useful in a building aerodynamics context. Unlike in industrial design field, building aerodynamics usually only requires a general idea of airflow. For this purpose, the non-uniform low grid resolution is sufficient.
- **Non-uniform high grid resolution.** The non-uniform high grid resolution is used at the final stage when convincing input data has been obtained and detailed results are required. It needs a considerable amount of disk space, RAM, and processing time. Additionally, a high grid resolution can introduce convergence problems.

As in the grid generation flow solution modelling should be started using absolutely simplified scenarios. As this experiment focuses on comparing C_p on the external wall surfaces, some simplification can be made, specifically negating heat transfers and windows (or openings). Thus, the problem can be defined as flow only, and the building can be defined as a massive block.

The grid resolution, problem and solution definitions should encourage a rapid convergence. Since CFD codes are based on the satisfaction of non-linear equations, they use an iterative calculation method. This method involves a huge number of calculations and significant computing time. Using a lower grid resolution for the preliminary trial and error will save on time.

Different CFD codes (non-commercial or commercial software) might have different operating modes. For CFD codes made by CFDRC, inputs for the flow solution are divided into two categories: defining the model of the flow and defining the method of solution. Inputs should be arranged so that the solution could evolve from a very simple to a more complex job until satisfactory results can be obtained. Flow definition includes:

- **Problem:** Incompressible airflow only (no heat transfer, no radiation). The building model

was defined as a block (no mass flow through the building). Two options of flow models were available: laminar and turbulent. A laminar flow is considered simpler than a turbulent flow. However, since airflows within and around buildings are almost always turbulent, selecting the turbulent flow model was preferable. The k-epsilon ($k-\epsilon$) model is one of the most popular turbulent models, especially in terms of its robustness and its production of reasonable results for building aerodynamics.

- **Fluid properties:** Air with constant density and viscosity. (Ideal gas law was used in heat transfer case. Solid properties are needed for heat transfer problems.)

- **Boundary condition:** Model was located in a box representing the flow domain (ie. the outdoor environment). The box has six faces (front = high, rear = low, top = north, bottom = south, left = west, right = east; see the Direction Agreement in Figure 8-1). Boundaries can be defined as thin-walls, walls, inlets, outlets, symmetry planes. In this experiment the boundaries of the big box were defined: west face as inlet, bottom as wall, east face as outlet. The rest of the

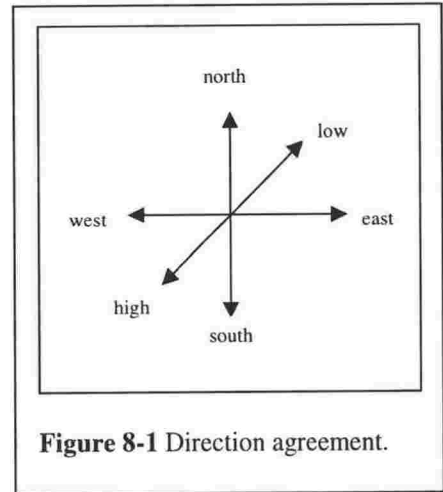

Figure 8-1 Direction agreement.

faces were defined as symmetry boundary conditions to allow for free airflow in any direction and for elimination of the non-slip wall condition. Thus, it avoided the squeezing effect caused by narrow paths between the model and walls, which is generally found in a wind tunnel. The thought behind this is that the big box, which represents the outdoor airflow domain, is actually only a part of the whole outdoor atmosphere. Gravity was set to 9.81 m/s^2 . Roughness heights were applied at the ground and model's surfaces. Air velocities (and directions), temperatures, and pressures are defined at inlets and outlets. For turbulent cases, turbulent kinetic energy and turbulent energy dissipation rate should be added at inlets and outlets. A thin-wall and a wall are different; a thin-wall is a surface, which is thinner than a cell. Unlike a wall, a thin-wall will still block airflow, but does not allow surface temperature and roughness height to be defined. For heat transfer cases, heat flux or surface temperature can be defined at the walls. For problems involving radiation, radiative properties should be defined at both the fluid and the solid. Symmetry boundary conditions are useful to tell the codes that the problem is symmetrical. Mirroring the results will give picture of the whole model.

- **Initial condition:** To provide the CFD codes with first estimates in a steady state simulation, initial condition values were applied. A good guess will result in a faster convergence but it is more difficult to make a good guess for a complicated model.

Solution method definition includes:

- **Calculation method:** Selecting the method used to solve the non-linear equations. The Upwind spatial differential method, the default, was considered a robust method, if not the most accurate.
- **Iteration:** The number of iterations predicted as sufficient to obtain a good convergence.
- **Under-relaxation:** Factors constraining change of a dependent or auxiliary variable from one solution iteration to the next.

The details of the model construction are as follows:

◆ **Geometry definition:**

Data of the Texas Tech. experimental building and its environment are based on articles published in Journal of Wind Engineering and Industrial Aerodynamic. Details and strategy are as follows:

◆ Geometry of the building and its environment.

◆ Geometry

- To imitate the real Texas Tech. experimental building and its environment a *box within a box* construction was applied. The smaller and larger boxes represented the building and its environment respectively. No flow was simulated inside the building, so it can be defined as a massive block. The shape of the building was made as close

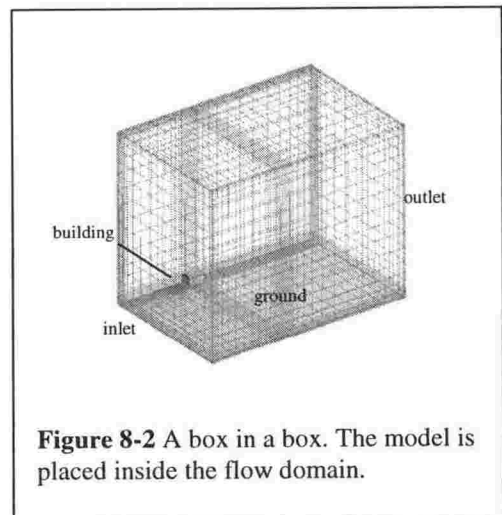

as possible to reality including the very low pitched roof. No door was applied.

- Since the building is symmetrical, it was only necessary to construct half of the building. This considerably reduced the memory space required as well as the computing time.
- The large box was made in such a way that its sides (except the symmetry plane or the half-cutting plane, and the ground) were far enough from the building. The preliminary experiments revealed that if these sides were too close to the building, a convergence problem occurred.

◆ Scale

There was no difficulty in constructing a full-scale model of Texas Tech. experimental building. All dimensions are in metres.

◆ **The grid:**

◆ Resolution

The grid resolution definition is the result of negotiation between accuracy requirements of the results and the efficiency of the calculation. In the preliminary experiments some problems occurred in this area.

- A low grid resolution gave a fast calculation and needed less memory space, but the degree of accuracy was poor for values near walls.
- Applying high grid resolution caused slower calculation and required more memory, without necessarily improving the problem. For vectors, higher resolution proved to disclose some turbulence close to walls, which were not shown by low grid resolution. C_p values, for example, were not solved properly. Using a non-uniform grid with hyperbolic-tangent to create a denser grid near the walls, becoming less dense further away, could improve the problem. Many bad aspect cells resulted, which would theoretically encourage convergence problems. However, in the preliminary experiment this was not the case. The bad cells did not become a convergence issue.¹⁰

◆ Block

To simplify the flow domain, all domains are composed to a single block domain.

◆ **The boundary condition.**

◆ Outlet, inlet, wall, symmetry planes.

- As already mentioned, the big box represents a *piece* of the whole environment where the building is being located. Rather than a box with solid walls, it has only imaginary walls. Air freely flows through them. Defining the walls as outlets, with one wall as an inlet (from where the air blows), can simulate this. Preliminary experiments found that these walls should be positioned away from the building to let the airflow stabilise before it reaches the building. It was also found that an inlet and outlet too close to the building resulted in a convergence difficulty.
- A symmetry plane is used since the Texas Tech. Experimental building is symmetrical along two axes. This is true only for airflow perpendicular to the axis. For oblique wind directions, the symmetric planes cannot be used.

◆ Flow solution:

◆ Model

- ◆ Grid. Since the geometry of the model was defined using separate modules (CFD-GEOM), all the geometric information (grid, boundary condition types, volume) was automatically imported by the flow solver module (CFD-ACE).
- ◆ Problem type. There are many options for the problem type. For building environmental simulations, a combination of four types is most relevant: incompressible flow, turbulence, heat transfer and radiation. Taking the problem type to be only incompressible flow will assume there is no turbulence, heat transfer, or radiation. On the other hand, taking the problem type to be only heat transfer will assume that there is no flow (therefore no turbulence) and no radiation. Considering that airflows around and within buildings are almost always turbulent, this experiment defined the problem type as an incompressible and turbulent flow. No heat transfer and radiation existed to simplify the simulation. Time dependence can be selected as either steady or unsteady; for this experiment, a steady state was chosen.
- ◆ Properties. Once a problem type is chosen, property information should then be defined. Depending on the definition of problem type, certain properties information should be supplied, specifically fluid, solid and radiative properties. For incompressible and turbulent flows as in this experiment, only fluid properties are necessary. The two fluid properties required are density (constant, temperature dependent, etc.) and viscosity (kinematic constant, dynamic constant, etc.). For this experiment, constant density (1.177 kg/m^3) and kinematic constant viscosity ($1.57\text{e-}005 \text{ m}^2/\text{s}$) were selected.
- ◆ Models. There are some turbulence models (Eddy viscosity, k - ϵ , Low Reynold, etc) that can be selected to model turbulent flow problems. The default turbulence model used by CFD-ACE is the standard k - ϵ model. According to Awbi, it is the most widely used model because of its applicability to process wide ranging flow problems, while making a lower computational demand than more complex models that are available.¹¹ However, it is claimed by Li¹² to be unreasonable for simulating airflows around buildings. Instead, he recommends the Large Eddy Simulation model (LES). Recent study by Cook and Lomas found that for buoyancy problems, the Re-Normalisation Group (RNG) k - ϵ model is more accurate.¹³ This

model is available in CFD-ACE.

- ◆ Boundary conditions. The air starts blowing from the inlet, flowing through the flow domain (the bigger box), striking the building (the smaller box) and exiting through the outlets. Air velocity, temperature, and pressure were defined at the outlet. It was not necessary to define these variables at outlets, as the flow solver would account for them. However, inputting these variables at the outlets would do no harm, as the flow solver would correct the values if they differed from calculated values. Data from Selvam's article was used; air velocity was set to 8.6 m/s. This is the speed of incoming wind at building height (4 m). For turbulence problem, turbulent kinetic energy (k) and turbulent energy dissipation rate (ϵ) should be defined. The following formula¹⁴ calculates k :

$$k = 0.5 (u'^2 + v'^2 + w'^2)$$

For Texas Tech., the longitudinal turbulence intensity (TI) is around 19% at four meters above the ground.¹⁵ For a wind speed of 8.6 m/s $u' = 0.19 \times 8.6 = 1.634$ m/s. Since the atmospheric boundary layer is not isotropic, $v' = 0.68u'$ and $w' = 0.45u'$ (approximately). Thus, $v' = 1.111$ m/s and $w' = 0.735$ m/s.

$$\begin{aligned} k &= 0.5 (1.634^2 + 1.111^2 + 0.735^2) \\ &= 2.22 \text{ J/kg} \end{aligned}$$

ϵ can be calculated from the following formula:¹⁶

$$\begin{aligned} \epsilon &= k^{1.5} / \lambda h \\ \epsilon &= 2.22^{1.5} / (0.005 \times 80) \\ &= 8.27 \text{ J/kg} \end{aligned}$$

k = turbulent kinetic energy, J/kg

λ = constant ~ 0.005

h = height of the enclosure

CFD-ACE provides an option to input length scale instead. The length scale is the diagonal of the inlet, in this case 80m (or any diagonal where the flow domain is changed).

Roughness height (RH) is defined at walls (ie. the building envelope and the ground). Roughness height has a value equal to about 5-10% of the average height of the terrain roughness elements (eg. houses, trees, etc.)¹⁷ Turbulence models are based on smooth wall assumptions. To account for additional losses at walls caused by roughness, roughness height of 0.024 and 0.0001 were added to, respectively, the ground and the building.¹⁸ Study by Lakehal on the application of the k- ϵ model to flow over a building placed in different roughness sublayers found that only the base pressure distribution was seriously affected by turbulence intensity and surface roughness.¹⁹ As there is no data on air temperature, in this experiment it was set to 300K (27°C)

- ◆ Initial condition. To start with, the flow solver requires values from the first trial or estimation. These values can be defined as the initial condition. As a precise prediction was difficult, the boundary values were used as initial guesses instead. The preliminary experiments showed that the guess using boundary values was far from correct, but they did not cause divergence.
- ◆ Flow solver
 - ◆ Method. By default, CFD-ACE selects Upwind (First-Order Upwind Scheme) closure method for the convection term in various sets of equations. It has first-order accuracy and is one of the most stable schemes.²⁰
 - ◆ Control. Since the calculation is conducted iteratively, the number of iterations can be specified. It should be sufficient to reduce the residuals down to five orders. The CFD-ACE developer suggests a three-order reduction of residuals to be reasonable. To allow tolerance towards change of dependent or auxiliary variables from one solution iteration to the next, under-relaxation can be used.
 - ◆ Output. For every execution, CFD codes give various outputs (air temperature, velocity in x, y, z, turbulent kinetic energy, turbulent dissipation rate, pressure, enthalpy, density, etc.). These can be combined to generate secondary outputs (humidity, mean radiant temperature, humidity, etc.).
 - ◆ Solution. After the problem has been defined, the calculation is taken over by the flow solver, which will continuously report on the temporary results of the iteration, as well as the convergence progression.

8.2.3 The Experiment

This sub-chapter discusses the experiment of aerodynamic and thermal calibration.

8.2.3.1 Preliminary Trial and Error

As mentioned, CFD-ACE results of C_p on the buildings' surfaces (windward and leeward sides) were compared to field data, Selvam's CFD results, Selvam's wind tunnel experiments, and the Opus wind tunnel experiments. Preliminary experiments employed a trial and error methodology. The experiment for calibration used 2D and 3D modelling.

Preliminary experiments focused on:

- Grid design.
- Achievement of fast and good convergence.
- Approaching the field data as closely as possible.

Preparatory study found that non-uniform grids have more advantages than uniform grids. They allow lower grid numbers without necessarily losing important data, because finer grid resolution can be allocated at critical places (such as building surfaces, or where the flow changes mostly occur).

The main problem with using a non-uniform grid is the occurrence of bad cells caused by extreme aspect ratios, leading to convergence problems. But, according to the CFD-ACE user support, the program can successfully handle this problem. This has been proved the case, as experiments containing bad cells did not show any difficulty in convergence. Non-uniform grids took less memory space and calculation time.

As long as the wind attacks the building perpendicularly (either to the long or short sides), the simulation can take advantage of the building's symmetrical configuration. It is possible to simulate just one half of the building, again saving memory and calculation time. Preliminary experiments showed that using the whole or just one half of the building give exactly similar results. This has been made possible by defining the cutting plane as a *symmetry* boundary condition.

To simulate wind flow around the building, a model should be placed within a flow domain. A *virtual* wind tunnel is thus made, and the model of Texas Tech. building put inside. Unlike a real wind tunnel, which has a limited dimension, the virtual wind tunnel does not. It can be built in any size, so that a full-scale model can be tested. The boundary of the flow domain can be defined in such away that the wind can flow in and out to simulate the real world. The

two ways of doing this are by defining the boundary conditions as outlets or symmetry planes. Preliminary experiments found that the latter option is better. Defining boundary conditions (north, low and high sides) as outlets would result in convergence problems, especially when they are too close to the model and roughness height is applied to the ground and building surfaces. Symmetry boundary conditions can simulate the imaginary boundary of the flow domain better, having no wall friction and allowing the wind to flow freely.

According to Dr Li,²¹ the inlet and outlet should be positioned at distances of at least six and twenty times the building height, respectively. Preliminary experiments found that the rule of thumb for minimum outlets distance can be used for symmetry boundary condition as well. The minimum inlet distance is also advantageous for 3D models with atmospheric boundary layers.

For 2D models both with and without boundary layer cases, the inlets should be placed at distances of, respectively, thirty and twenty times the building height. For 3D models without an atmospheric boundary layer, the inlet should be put twelve times the eaves' height away. Placing the inlet closer or farther than that distance causes, respectively, increase or decrease of C_p magnitudes. In the main experiment, to reduce the number of variables, the inlets were defined to be ten times the eaves' height away

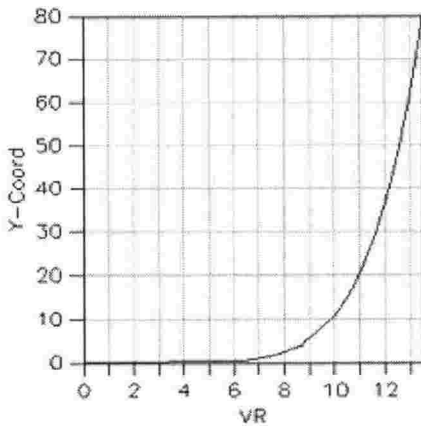

Figure 8-3 Atmospheric boundary layer wind profile

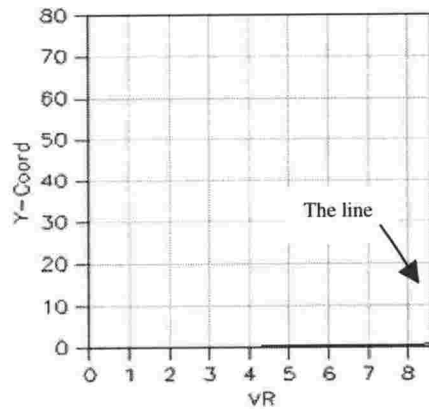

Figure 8-4 Uniform wind flow profile

List of the parameters being used:

- Building dimension: full scale, 4x9.1x13.7m
- Incoming mean wind speed²²: 8.6 m/s at eaves' height (4 m)
- Roughness height²³, ground ~ 0.024, building surfaces ~ 0.0001
- Air property, temperature: 300K; density: 1.177 kg/m³; kinematic viscosity: 1.57e-5 m²/s
- Gravity: -9.81 m/s²
- Atmospheric boundary layer was, if used, defined by using the power law equation:²⁴

$$V_h = V_{bl} \cdot (h/h_{bl})^\alpha$$

Where, V_h = wind speed at the height of a given point, m/s
 V_{bl} = gradient speed, the wind speed at the height of boundary layer, m/s
 h = the height of a given point, m
 h_{bl} = gradient height, the height of the boundary layer, m
 α = mean speed exponent

- $k = 2.22 \text{ J/kg}$ and $\epsilon = 8.27 \text{ J/kg}$ s

Table 8-1 Values of gradient height, power law exponents and roughness height.²⁵

Terrain category	Terrain description	Gradient height, h_{bl} (m)	Roughness height (m)	Mean speed exponent, α
1	Open sea, ice, tundra, desert	250	0.001	0.11
2	Open country with low scrub or scattered trees	300	0.03	0.15
3	Suburban areas, small towns, well wooded areas	400	0.3	0.25
4	Numerous tall buildings, city centres, well developed industrial areas	500	3	0.36

Criteria are needed to compare and evaluate the results of experiments. For this experiment, selection of criteria has been based on data availability and its significance to building ventilation problems. This led to the selection of the Pressure Coefficient (C_p) as the parameter.

The Pressure Coefficient (C_p) is a common (and a more convenient) way of presenting pressure data^{26,27} and is calculated using the following formula:

$$C_p = (P - P_o) / 0.5 \cdot \rho \cdot V^2$$

Where, P = local pressure, Pa
 P_o = reference pressure, Pa
 ρ = air density, kg/m³

V = mean approaching wind speed at eaves height, m/s.

The reference pressure (P_o) at free flow is considered to be zero.²⁸ P is the local pressure on the surface, and $(0.5 \cdot \rho \cdot V^2)$ is the dynamic pressure at the reference point, in this case at eaves height (V being the mean incoming wind speed at this point).

Using the C_p data, five criteria are defined:

- Average windward C_p difference to the field data
- Average leeward C_p difference to the field data
- Windward maximum C_p difference to the field data
- Leeward maximum C_p difference to the field data
- Maximum inlet/outlet difference between CFD results and the field data.

The first two criteria are used to study the capabilities of the CFD program to simulate wind pressure on windward and leeward surfaces by averaging the C_p differences (between CFD calculation and the field data) at given points. The second two criteria are used to study the difference between the absolute values of maximum C_p (between CFD calculation and the real condition) on windward and leeward surfaces. The final criterion finds the inlet/outlet C_p difference and determines how it differs from the field data. This criterion is useful to study whether the C_p differences will give the same effect on the ventilation rate.

No guide is available to determine an acceptable deviation of results. The simple rule is to get the smallest possible deviation or make CFD results as close as possible to the field data. How close, though? An ideal result shows exactly the same values as the field data. Currently, this is difficult to achieve, as CFD codes are *progressing* towards perfection, and have not yet reached it. Terms such as *agree well* and *very good agreement* seem more realistic, and have been used by many authors in qualitatively explaining the degree of similarity. Consequently, there has to be an accepted degree of tolerance. (Please see 2.5.1 Analysis and Assessment of the Experiment for Calibration.)

8.2.3.2 The Main Experiment

Following the preliminary experiments, which mostly dealt with basic CFD procedure (efficient grid, fast and good convergence, and a rough and quick approach to match results with field data) the next experiments (the main experiments) focussed on the accuracy and precision of the results. Issues, or topics, relating to the effect of different models on the accuracy and precision of CFD results can be selected and developed from various aspects of CFD itself. From the earliest stage of the CFD modelling, the geometric definition, to the final stage, calculation, interesting issues became apparent. Examples of the former include the effects of grid resolution

(coarse/ fine grid), grid patterns (uniform/ non-uniform grid), and the dimensionality (two/ three dimension) on the accuracy of the results. An example of the latter includes the effects of turbulent model (standard $k-\epsilon$, RNG $k-\epsilon$, etc.) on the accuracy of the results.

In this experiment three topics have been selected. These involve cases based on combination of 2D/3D, the $k-\epsilon$ /RNG turbulent model, and modelling both with atmospheric boundary layer/without atmospheric boundary layer. Table 8-2 lists the cases of the experiments.

The purpose of comparing 2D and 3D cases is to gauge their ability to simulate wind flow. Two-dimensional modelling offers some advantages, requiring less memory space, preparation, and calculation time than three-dimensional modelling. The latter, however, is considered more realistic in simulation of wind flows around buildings, which are always three-dimensional.

The purpose of comparing $k-\epsilon$ and RNG (re-normalisation group) to the $k-\epsilon$ turbulent model is to find the most precise model for given cases. The standard $k-\epsilon$ model is the most widely used. It is robust, but its accuracy in simulating wind flow around buildings remains arguable. Some experts (such as Li²⁹) found it not so reliable, but others believe it reasonable to determine a rough idea of the wind flow. Paterson states that in good CFD programs, the $k-\epsilon$ turbulent model can produce good results, although he recommends using the RNG turbulent model.³⁰

The purpose of comparing simulation with and without an atmospheric boundary layer is to study how far the boundary layer affects the C_p . Preliminary experiments found that placing the inlet far away from the model results in good C_p values, in agreement with field data, even though there was no boundary layer applied. This is because the application of roughness height on the ground has generated a kind of inherent boundary layer effect.

8.2.4 Results and Discussions

Three issues are studied: C_p values on windward and leeward surfaces, and the inlet/outlet C_p difference. All are subject to comparison with field data.

In general, there is no single ideal combination. It seems that what one needs to know will dictate the selection of the combination. One combination can simulate, for example, a good windward C_p but a bad leeward C_p . In a more specific term, one will be probably be more

concerned with, for example, the inlet/outlet C_p difference, ignoring other details. This is because he/she only requires inlet/outlet C_p difference to design indoor ventilation.

Table 8-2 The cases of aerodynamic calibration.

2D				3D			
Without atmospheric boundary layer (uniform wind profile)		with atmospheric boundary layer		Without atmospheric boundary layer (uniform wind profile)		with atmospheric boundary layer	
k-ε	RNG k-ε	k-ε	RNG k-ε	k-ε	RNG k-ε	k-ε	RNG k-ε
2d-case1	2d-case2	2d-case3	2d-case4	3d-case1	3d-case2	3d-case3	3d-case4

Table 8-3 The rank.

	2d-case1	2d-case2	2d-case3	2d-case4	3d-case1	3d-case2	3d-case3	3d-case4
Average windward C_p difference	1	2	5	6	3	4	7	8
Average leeward C_p difference	2	4	1	3	8	6	7	5
Windward Max C_p difference	1	2	5	6	3	4	7	8
Leeward Max C_p difference	2	4	1	3	8	6	7	5
Max inlet/outlet C_p difference - field data (0.85)	1	2	3	4	5	6	8	7
Total	7	14	15	22	27	26	36	33

Note: The range: good (8) < -- > bad (1)

Table 8-3 simplifies the conclusion. This table ignores individual topic significance, treating all topics (windward C_p difference, leeward C_p difference, etc.) equally (no different weighting being applied). Each case is given a ranked value in a given topic, ranging from eight (the best) to one (the worst). It is clearly seen that 3D-case3 is the best, followed by 3d-case4, 3d-case1 and so on. 2d-case1 is the worst. Studying in detail, however, one would see that there is no perfect combination. For example, 3d-case3 is, in overall, better than 3d-case4. However, in some points (average windward C_p difference, windward max C_p difference) 3dcase4 is better

than 3d-case3. It is easy to compare the CFD-ACE performance for a certain topic only by seeing the numbers. Bigger number shows better performance.

Some other comparisons can be derived from Table 8-3 as follows:

- In general 3D modelling is better than 2D modelling. (3d-case1 is better than 2d-case1; 3d-case2 is better than 2d-case2, etc.).
- Applying the atmospheric boundary layer is better than not applying it (2d-case3 is better than 2d-case1; 3d-case3 is better than 3d-case1, etc.).
- The standard k- ϵ turbulent model is better than RNG k- ϵ turbulent model when used for a three-dimensional simulation (3d-case1 is better than 3d-case2; 3d-case3 is better than 3d-case4). However, for a two-dimensional simulation, RNG k- ϵ turbulent model is better (2d-case2 is better than 2d-case1; 2d-case4 is better than 2d-case3).

Table 8-3 describes both the overall and individual performances. It should be used carefully if focusing on a specific topic (only studying the average windward C_p difference, for instance). As mentioned, overall, 3d-case3 is better than 3d-case4, while for some points it does not perform as well as 3d-case4.

The important question is whether one could use the 3d-case3 scenario without having to be bothered by each individual topic. To answer this question it is worth considering the CFD-ACE results in their absolute values. Figure 8-6 to Figure 8-9 graphically compares the cases with other experimental data (using wind tunnel and CFD program) as well as the field data. It can be seen in Figure 8-6 that CFD-ACE with scenario 3d-case3 produces much better results than other experiments. Its average windward C_p difference to the field data is only 0.027. It is much lower than other CFD programs which claim to have a good agreement, specifically Selvam's CFD, of 0.067. Figure 8-9 shows that 3d-case3 inlet/outlet C_p differences - field data inlet/outlet C_p difference (0.85) is 0.003. It is much better than Selvam's CFD result, 0.11. It is also much better than Selvam's and Opus' wind tunnel experiments, which are, respectively, 0.07 and 0.13. In Figure 8-6 to Figure 8-9, 3d-case3 shows equal or better results for all topics than Selvam's CFD. Thus, in general, CFD-ACE can very closely simulate the real condition.

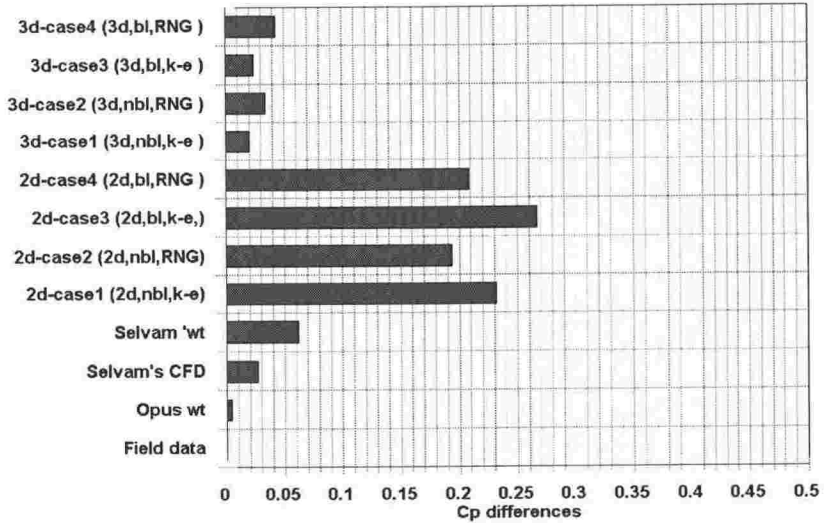

Figure 8-5 Average C_p differences (relative to the field data, leeward).

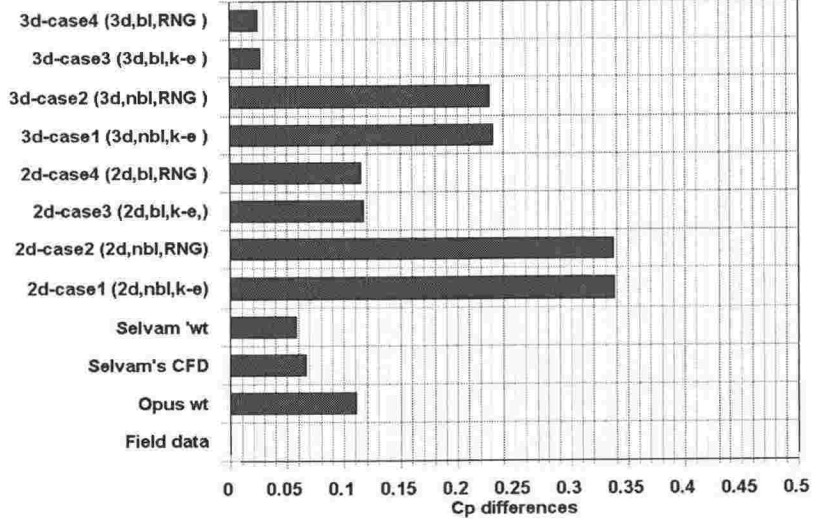

Figure 8-6 Average C_p differences (relative to the field data, windward).

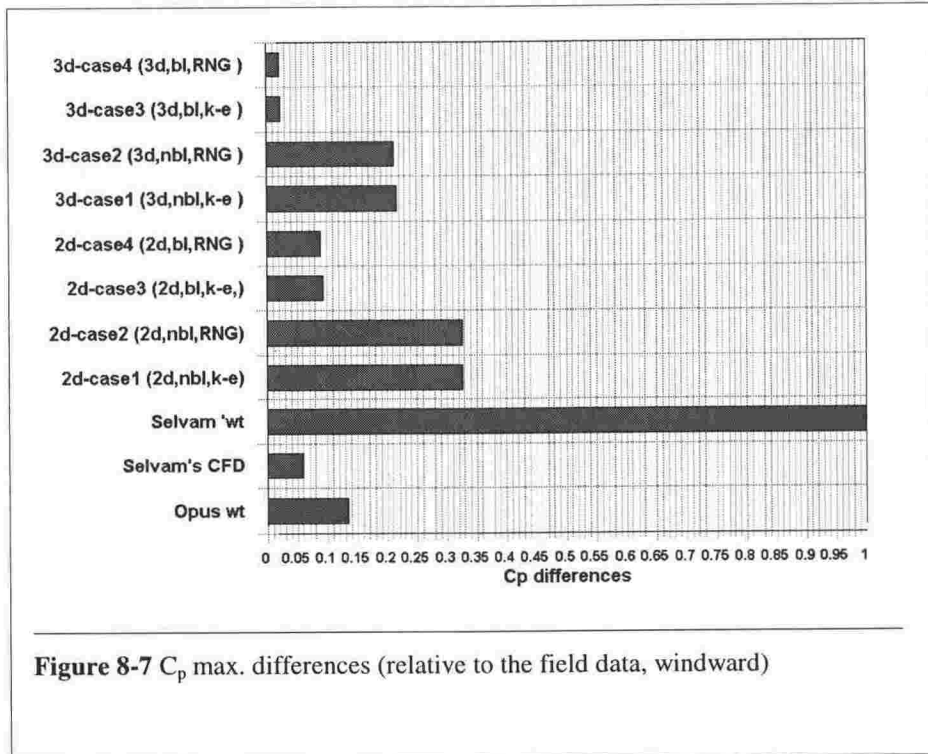

Figure 8-7 C_p max. differences (relative to the field data, windward)

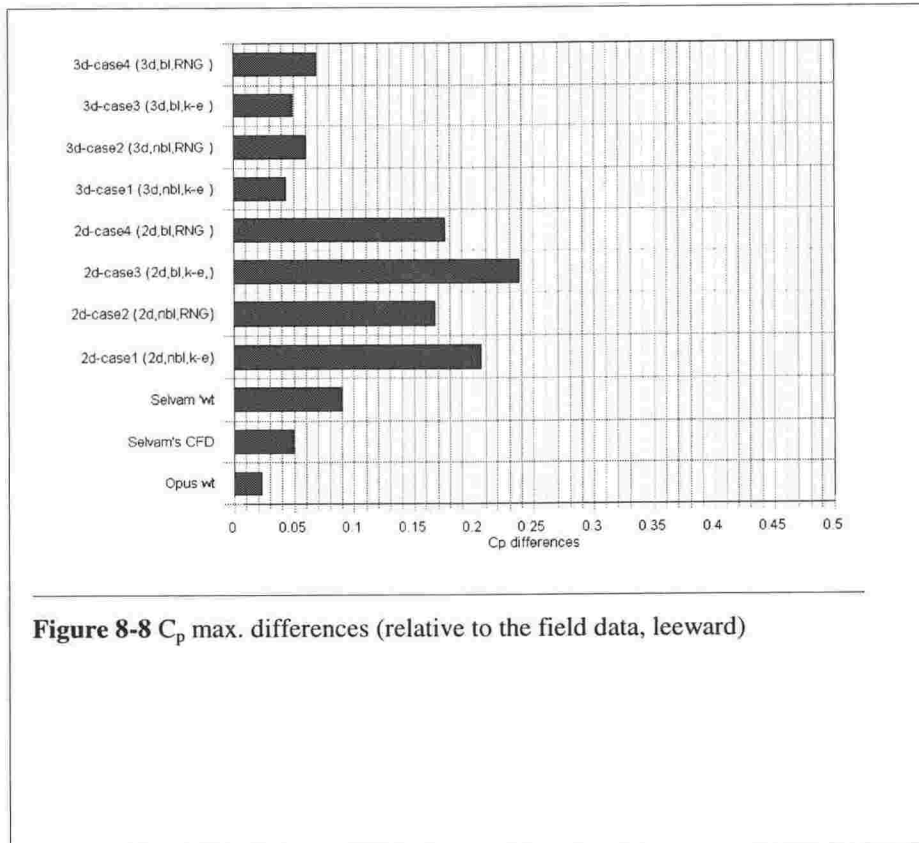

Figure 8-8 C_p max. differences (relative to the field data, leeward)

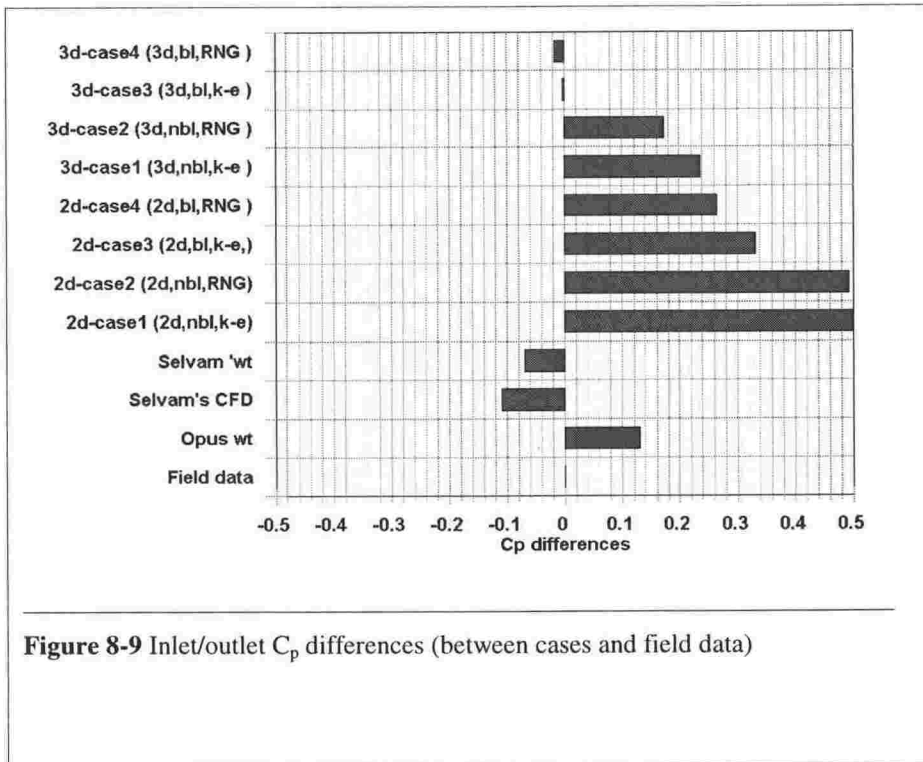

Figure 8-9 Inlet/outlet C_p differences (between cases and field data)

Despite the close competition between 3d-case3 and 3d-case4, the former scenario is considered to be better and should be able to be used confidently for other cases. Using a scenario such as 3d-case3 (a combination of three dimensional model, standard k- ϵ turbulent model and atmospheric boundary layer) CFD-ACE program can well simulate the real condition.

8.3 Experiment for Thermal Calibration

This sub-chapter discusses in detail the experiment for heat transfer calibration. The procedure of model construction is not explained here as it was basically the same as that of the experiment for aerodynamics calibration.

8.3.1 Data of the Model

As discussed, two references were used. For a two-dimensional calibration, a study by de Vahl, as reported by Baker³¹, was used. Meanwhile, for three-dimensional cases, a study by Baker, Williams and Kelso was used. Some degree of tolerance is allowed for the comparison technique between the thermal calibration experimental results and references due to the lack of data format. Unlike field data from the Texas Tech. experimental building, which was recorded and written in spreadsheet format, reference data for thermal calibration is only available in printed publication in the form of graphics. The profiles of the temperature contour lines are obvious,

but the magnitude between these contour lines cannot be precisely obtained. This problem is obvious for the three-dimensional cases. The gridding technique is used to visually interpolate the magnitude between contour lines. Despite the lack of precision, this technique is considered to be sufficient for this thermal calibration purpose.

De Vahl used a simple square with a non-uniform 32^2 mesh. Although he did not mention any specific fluid and Pr numbers, he conducted his experiments for laminar flows on $10^3 \leq Ra \leq 10^6$. (Rayleigh number is the product of Grashof and Prandtl numbers. Grashof number is a dimensionless number being the ratio of the buoyancy forces to the viscous forces used in modelling free convection flow. Prandtl number is a dimensionless number being the ratio of the kinematic viscosity of a fluid to its thermal diffusivity used in modelling free convection flow.)

Baker, Williams, and Kelso use a simple non-dimensional box with the length : width : height of 1:2:1. Since the box is symmetrical, only half of it needs to be modelled. The grid numbers for the length, width and height of the box are, respectively, 18, 30 and 30. The experiment is conducted for $Ra = 1.5 \times 10^5$ and $Pr = 0.71$. This is within the range of laminar flow. Two opposing vertical walls were defined as hot and cold. The grid was uniformly distributed.

8.3.2 Experiment Preparation

The preparation step for two and three-dimensional problems was straightforward as the geometric definition, including the grid numbers, has been produced in the Baker article.³² Thus, the geometry can be simply built using the available data. Since the square and the box are non-dimensional, in this experiment only the ratio of length:width(:height) was maintained. One unit is defined as one meter.

For two-dimensional problems, a simple square with a non-uniform 32^2 mesh has been constructed. To obtain $10^3 \leq Ra \leq 10^6$ the following formula is used:

$$Ra = Gr \times Pr$$

$$= (\beta \Delta T g L^3 / \nu^2) \times Pr$$

where Gr = Grashof number
 Pr = Prandtl number
 β = air volumetric expansion
 ΔT = temperature difference
 g = gravitation
 L = the reference length
 ν = kinematic viscosity

Since de Vahl did not mention any specific fluid, in this experiment the air at 300K ($\nu=1.57 \times 10^{-5}$ Pr=0.69) is selected. Substituting these values in the formula and using trial and errors, the $Ra=10^3$ can be obtained if $\Delta T=10.936$ and $L=0.01$. Thus, the hot and cold walls can be defined as 310.936K and 300K. Changing L to 0.02154, 0.0464 and 0.1 while maintaining the other values, will produce $Ra = 10^4, 10^5$ and 10^6 respectively.

For a three-dimensional problem, $Ra = 1.5 \times 10^5$ and Pr=0.71 are used. To obtain that Ra value, the actual dimension of the box and the temperature difference between the hot and the cold walls (ΔT) should be adjusted. The carbon dioxide at 300K is selected as the fluid. It has Pr=0.71 and kinematic viscosity (ν) = 8.5×10^{-6} . The temperature difference, ΔT , can be obtained using the following formula:

$$\begin{aligned} Ra &= Gr \times Pr \\ &= (\beta \Delta T g (L)^3 / \nu^2) \times Pr \end{aligned}$$

Since $\beta=1/T$, for $T = 300K$, $\beta = 1/300$. L is assumed as 0.1 m, then

$$\begin{aligned} 1.5 \times 10^5 &= ((1/300)(\Delta T)(9.8)(0.1)^3 / (8.5 \times 10^{-6})^2) \times 0.71 \\ \Delta T &= 0.47^\circ C \end{aligned}$$

Thus, if the cold wall is set to 300K, then the hot wall should be at 300.47K.

As in the aerodynamics calibration, the thermal calibration applied two limitations. The first was the same as that of the aerodynamic calibration (see 8.2.2). The second limited this research to comparing only non-dimensionalised temperature profiles. For two-dimensional problems, the results of CFD-ACE were compared to the de Vahl Davis experiments. For three-dimensional problems they were compared to Baker, Williams, and Kelso's experiments at horizontal and vertical mid-cutting planes.

CFD-ACE, the flow solver, does not give many options to control the calculation method for laminar flow. The only option is for spatial differencing schemes, which are used to calculate the convective terms in the transport equations for the dependent variables specified.³³ For turbulent flows, however, the program offers a selection of turbulent models to use. Two often used models are the standard k- ϵ and RNG k- ϵ turbulent models.

8.3.3 The Experiment

This sub-chapter discusses the experiment for thermal calibration.

8.3.3.1 Preliminary trial and errors

Preliminary two-dimensional experiments found that for all Ra numbers, except $Ra=10^6$, the flow solver could obtain good convergence. For $Ra=10^6$, the mesh resolution should be increased and the problem should be changed from laminar to turbulent flow. A trial using a non-uniform 100^2 mesh helped the flow solver to converge.

Preliminary experiments also found that CFD-ACE sometimes had convergence difficulties for Ra close to 10^5 and 10^6 . This is the transitional range from laminar to turbulent flow. To fix the problem, the flow should be set to turbulent, even though theoretically the flow is still laminar. The existence of turbulent flows seems to be more frequent than laminar flows for gases. Preliminary experiments, and manual calculation, found that $Ra < 10^5$ for gases, such as air, will occur if L (the reference length, usually the height of the walls) and ΔT (the temperature difference) are small (say, $L < 0.1\text{m}$ and $\Delta T < 1^\circ\text{C}$). Laminar flows are more unlikely to occur in the environment of larger L and ΔT . If the program is forced to treat such an environment as having laminar flows, it is likely that it will have convergence problems. In most cases this problem can be easily fixed by redefining the flow as turbulent.

8.3.3.2 The main experiment

In the thermal calibration six cases are defined for comparison, i.e. three two-dimensional and three three-dimensional experiments. To simplify the experiments only two Ra numbers are used, $Ra=10^5$ and $Ra=1.5 \times 10^5$ for, respectively, the two and three-dimensional experiments. Theoretically, $Ra=10^5$ indicates a laminar flow though it is close to the $Ra=10^6$ which indicates a transition to a turbulent flow. Table 8-4 lists the cases.

Two points are observed. Those are the differences of the non-dimensionalised temperature in a horizontal and a vertical mid-cutting plane.

Table 8-4 The cases of thermal calibration.

2D			3D		
Laminar	Turbulent		Laminar	Turbulent	
	k- ϵ	k- ϵ RNG		k- ϵ	k- ϵ RNG
2d-case1	2d-case2	2d-case3	3d-case1	3d-case2	3d-case3

8.3.4 Results and Discussion

Graphically, for two-dimensional problems, the results of experiments using CFD-ACE are in a

very good agreement with the de Vahl's experiments. In terms of magnitude, however, there is a slight difference. The 2d-case1 (laminar) and 2d-case3 (turbulent with RNG model) show exactly the same results. The 2d-case2 (turbulent with standard k- ϵ model) produces a better result than both of the others. This might indicate that setting the program to either laminar or turbulent flow in the transition range ($Ra \sim 10^5$) will not give any effect. However, considering that in relatively large L and ΔT (for air) turbulent flows are more likely to occur than laminar flows, it is wiser to set the program to the turbulent model.

All the three two-dimensional cases show very similar results. The laminar model gives a similar result to the turbulent models. Both turbulent models, the standard k- ϵ turbulent and RNG k- ϵ , produce almost exactly the same results (It is very difficult to see the difference using the gridding technique.) This contradicts the growing opinions that the latter, originally designed to improve standard k- ϵ turbulent in dealing with convective heat transfer, is better. Also, a study by Cook and Thomas found that RNG k- ϵ turbulent model gave a significant improvement on standard k- ϵ models when simulating buoyancy-driven displacement ventilation flows.³⁴ The average non-dimensionalised temperature differences between the three cases and de Vahl experiment are 0.003 and 0.064 at the horizontal and vertical mid-cutting planes, respectively.

The three-dimensional experiments (three cases: laminar flow, turbulent with standard k- ϵ , and turbulent with RNG k- ϵ model) also show relatively similar results. The experiments using CFD-ACE and Baker's experiment can successfully reproduce what are called *inertial end effect* and *thermal end effect*.³⁵ These two mechanisms appear to cause axial flows. The first effect is due to the kinematic interaction of the rotating fluid with the stationary end-walls. The second effect is caused by the axial temperature gradients near the ends of the box generated by variations in the flow field. The effect of no-slip end-walls is more obvious in Baker's experiments than in CFD-ACE results. The temperature profiles at the adiabatic walls of the three cases describe a good agreement with Baker's experiments. However, at the horizontal and vertical mid-cutting planes the temperature profiles are slightly different. The difference at the horizontal and vertical mid-cutting planes between the three cases and Baker experiments are 0.035 and 0.057 respectively.

From the six experiments, it can be seen that the three-dimensional experiments are closer to the reference for the vertical temperature gradient (Figure 8-10). Meanwhile, two-dimensional experiments produce closer results (with de Vahl Davis's works as reference) than the three-dimensional experiments do (with Baker's works as reference) for the horizontal temperature gradient (Figure 8-11).

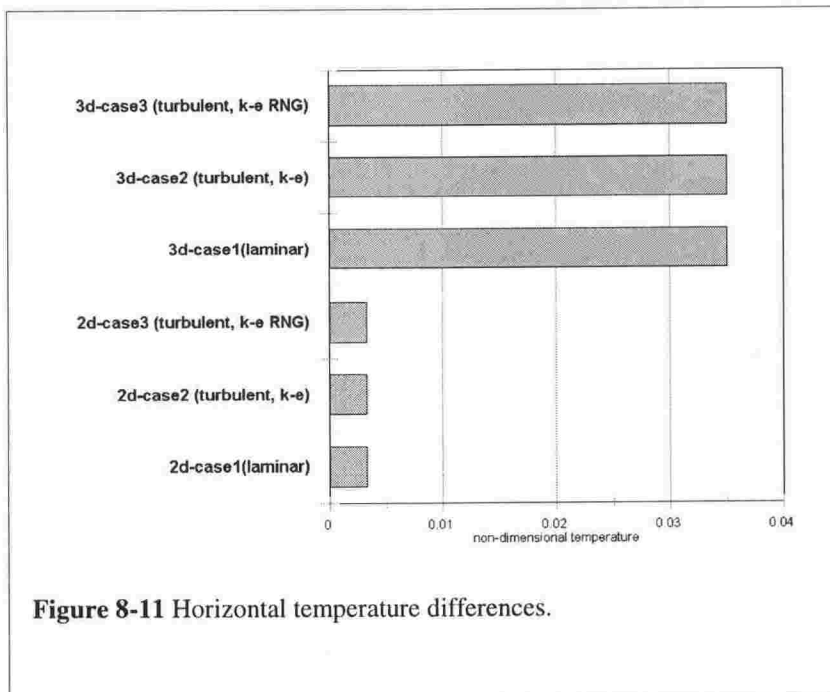
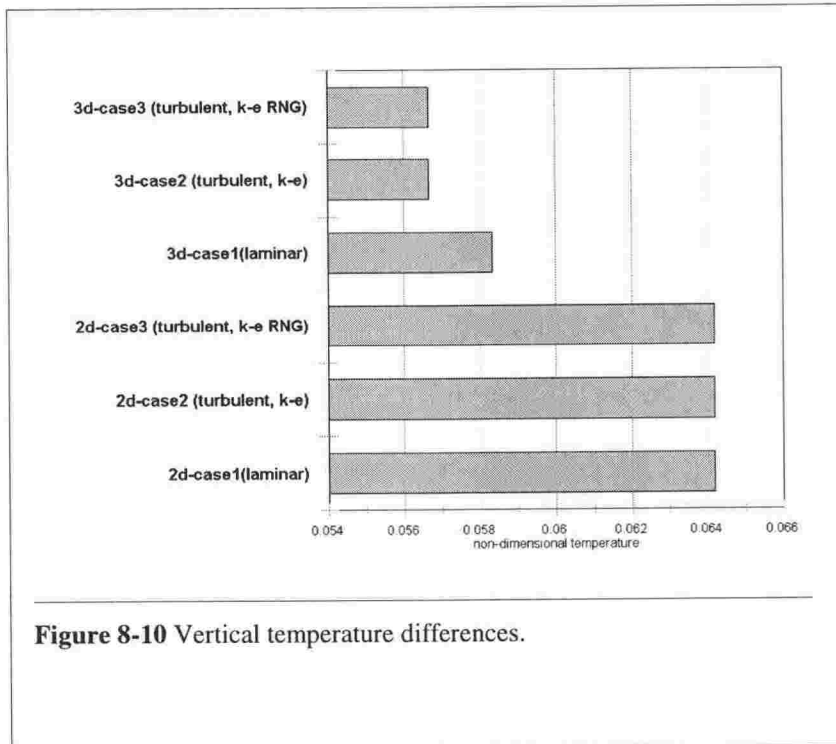

8.4 Correlation between Data Input and Results

It was found during the experiments that selecting input data to force the CFD program to reproduce a real world phenomenon was not easy. Factors involved in air movement (driving

forces, directions, obstructions, etc.) are very complex. It seems impossible for the CFD program to handle them all at once. However, the *very good agreement* between CFD results and the field data shows that it is not entirely impossible to reproduce real world phenomena. A combination of selected input data, a carefully constructed model, and a good CFD program could produce satisfying results.

The input data used, which were actually simplifications of the complicated real world phenomena, could guide the CFD program to reproduce reality. The work of experts in representing the real world phenomena by equations and numbers have made it possible for the CFD program to reproduce real phenomena as close as possible. The application of an atmospheric boundary layer (which is constructed from the power law equation) instead of a uniform wind profile, for example, has proved that the complicated wind profile can be represented by a relatively simple equation.

8.4.1 Air Temperatures

The thermal calibration shows that CFD-ACE can accurately calculate air temperature. The buoyancy-driven flow, which is important in the building heat transfer, can be well simulated.

The capability of the CFD-ACE to simulate the mean radiant temperature (MRT) of the surrounding surfaces cannot be calibrated. The MRT is important in determining the Predicted Mean Vote (PMV) and thus the comfort degree of the indoor atmosphere. The program has the ability to simulate convective and radiative heat transfers simultaneously.

8.4.2 Airflow Patterns and Velocities

Though it has not been extensively observed, the CFD-ACE is able to produce realistic airflow patterns. Despite the lack of field data in confirming the external airflow pattern of the Texas Tech. building, the CFD-ACE results show very logical airflow patterns (such as the presence of eddies behind the building). A reference of internal airflow pattern is provided by Baker (i.e., stack effect inside a simple cavity). CFD-ACE could simulate the internal airflow, which was very similar to Baker's experiment (see Figure 8-18 to Figure 8-23).

8.4.3 Air Humidity

There is no data readily available to calibrate the capability of the CFD-ACE program in simulating air humidity though it has the facility to calculate the humidity. Calculating air humidity will increase the complexity of the calculation. Considering that the air humidity inside the Javanese building does not vary widely, it may then be represented as a constant.

8.4.4 Optimised Input Data

The common rule in the CFD application (beside the famous *garbage in garbage out* rule) is always to start with the simpler model and upgrade it gradually until a satisfying result is obtained. In the CFD program, a problem can be isolated so that missing input data is tolerable. In the experiment for aerodynamics calibration, for example, the heat transfer calculation option has been disabled leaving only the flow problem. There is no field data on the involvement of heat (solar heat) in the airflows around the Texas Tech. experimental building, even though the heat will theoretically affect the air temperature as well as air humidity and density. The absence of such data has forced the experiment for aerodynamic calibration to use the default setting of the CFD program (which is based on ordinary atmospheric conditions) and only to calculate the flow. This has thus reduced the complexity of the problem without necessarily sacrificing the results.

8.5 Summary

- The aerodynamics and heat transfer calibration show that the CFD-ACE program could become a reliable research tool. The parameter deviations between CFD-ACE results and the references (field data of the Texas Tech. building and Baker's work) were very small.
- For external flow simulation, aerodynamics calibration, it was found that a combination of three-dimensional model, atmospheric boundary layer, and standard k- ϵ turbulence model could well reproduce the real world airflow.
- For thermal calibration, it was found that combination of three-dimensional model with a standard k- ϵ turbulence model was sufficient.

The following chapter (Chapter Nine) will discuss the experiment studying aerodynamics performance of Javanese residential buildings.

Endnotes

¹ For the different between heat transfer and thermodynamics, please refer to Mills, A.F., 1992, Heat Transfer, Boston: Irwin.

² Levitan, M.L., Mehta, K.C., Texas Tech Field Experiments for Wind Loads part I: Building and Pressure measuring System, Journal of Wind Engineering and Industrial Aerodynamics, 41-44 (1992), pp. 1565-1576.

³ Levitan, et al., op. cit., pp. 1577-1588.

⁴ Cochran, L.S., Cermak, J.E., Full- and Model -Scale Cladding Pressures on the Texas Tech University Experimental Building, Journal of Wind Engineering and Industrial Aerodynamics, 41-44 (1992), pp. 1589-1600.

⁵ Okada, H., Ha, Y, Comparison of Wind Tunnel and Full-Scale Pressure Measurement Tests on the Texas Tech Building, Journal of Wind Engineering and Industrial Aerodynamics, 41-44 (1992), pp. 1600-1612.

⁶ Selvam, R.P., Computation of Pressure on Texas Tech Building, Journal of Wind Engineering and Industrial Aerodynamics, 41-44 (1992), pp. 1619-1627.

⁷ Surry, D., 1991, Pressure Measurements on the Texas Tech. Building: Wind Tunnel Measurements and Comparisons with Full Scale, Journal of Wind Engineering and Industrial Aerodynamics, 38 (1991), pp. 235-247.

⁸ Cochran, et al., loc. cit., pp. 1589-1600.

⁹ Selvam, R.P., loc.cit., pp. 1619-1627.

¹⁰ An Internet communication with the CFD-ACE developer on 13 January 1998 confirmed that these bad cells would not affect the convergence.

¹¹ Awbi, H.B., 1991, Ventilation of Buildings, London: Chapman and Hall, p.219.

¹² E-mail on 8 January 1998.

¹³ Cook, M.J., Lomas, K.J., 1998, Buoyancy-driven Displacement Ventilation Flows: Evaluation of Two Eddy Viscosity Turbulence Models for Prediction, Proc. CIBSE A: Building Service Engineering Research Technology, 19 (1) 15-21(1998).

¹⁴ Awbi, H.B., op. cit., p. 232.

¹⁵ Levitan, M.L., Mehta, K.C., Texas Tech Field Experiments for Wind Loads part II: Meteorological Instrumentation and Terrain Parameters, Journal of Wind Engineering and Industrial Aerodynamics, 41-44 (1992), pp. 1577-1588.

¹⁶ Awbi, H.B., 1991, Ventilation of Buildings, London: Chapman and Hall, p.233.

¹⁷ Aynsley, R.M., Melbourne, W. and Vickery, B.J., 1977, Architectural Aerodynamics, London: Applied Science Publisher, Ltd., p.90.

¹⁸ These two figures are taken from Selvam, R.P., Computation of Pressure on Texas Tech Building, Journal of Wind Engineering and Industrial Aerodynamics, 41-44 (1992), pp. 1619-1627.

¹⁹ Lakehal, D., 1998, Application of the k-e Model to Flow Over a Building Placed in Different Roughness Sublayers, Journal of Wind Engineering and Industrial Aerodynamics, 73 (1992), pp. 59-77.

²⁰ CFDRC, 1993, CFD-ACE Theory Manual Version 1.0, Huntsville: CFD Research Corporation, p.4-5.

²¹ through discussions by e-mails

²² Selvam, R.P., loc. cit., pp. 1619-1627.

²³ Ibid.

²⁴ Aynsley, R.M., et al., op cit., p.89.

²⁵ Ibid.

²⁶ Etheridge, D., Sandberg, M., 1996, Building Ventilation: Theory and Measurement, Chichester: John Wiley and Sons, p.20.

²⁷ Aynsley, R.M., et al., loc.cit., p.189.

²⁸ Selvam, R.P., loc. cit., pp. 1619-1627.

²⁹ Li, Y., General Flow and Thermal Boundary Conditions in Indoor Air Flow Simulation, Building and Environment, vol.29 (1994), no.3, pp.275-281.

³⁰ CSIRO, through discussions by e-mails.

³¹ Williams, P.T., Baker, A.J., Kelso, R.M., 1996, Numerical Calculation of Room Air Motion - Part 2: The Continuity Constraint Finite Element Method for Three-Dimensional Incompressible Thermal Flows, in ASHRAE Transactions, vol.100, part 1.

³² Ibid.

³³ The theoretical explanation of this issue is far beyond this thesis experiment, so it will not be discussed here. Please refer to CFDRC, 1998, CFD-ACE Command Language Manual, v 4.0, Huntsville: CFD Research Corporation, for more information.

³⁴ Cook, M.J., Lomas, K.J., 1998, Buoyancy-driven Displacement Ventilation Flows: Evaluation of Two Eddy Viscosity Turbulence Models for Prediction, Proc. CIBSE A: Building Service Engineering Research Technology, 19 (1) 15-21(1998)

³⁵ Williams, P.T., Baker, A.J., 1996, Incompressible Computational Fluid Dynamics and the Continuity Constraint Method for the Three-Dimensional Navier-Stokes Equations, Numerical Heat Transfer, Part B: Fundamentals, 29(2), pp.137-273.

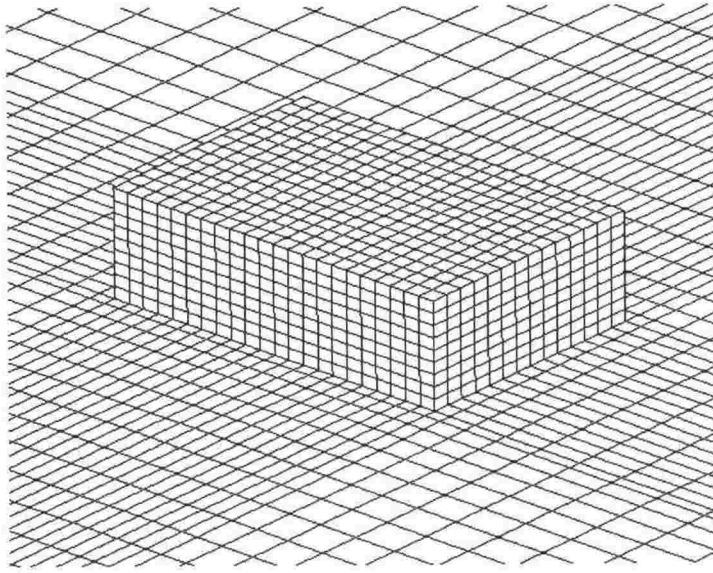

Figure 8-12 Grid design of the Texas Tech experimental building model generated by CFD-GEOM based on structured grid system.

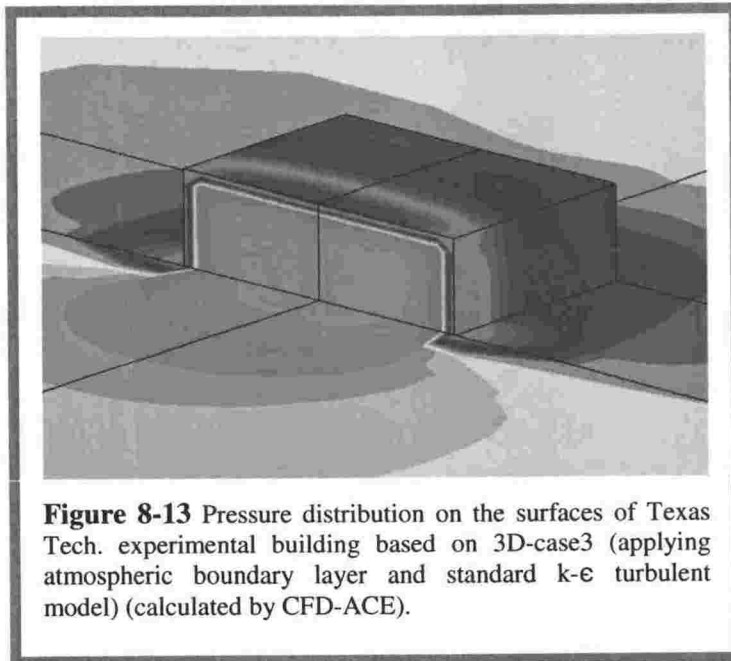

Figure 8-13 Pressure distribution on the surfaces of Texas Tech. experimental building based on 3D-case3 (applying atmospheric boundary layer and standard k- ϵ turbulent model) (calculated by CFD-ACE).

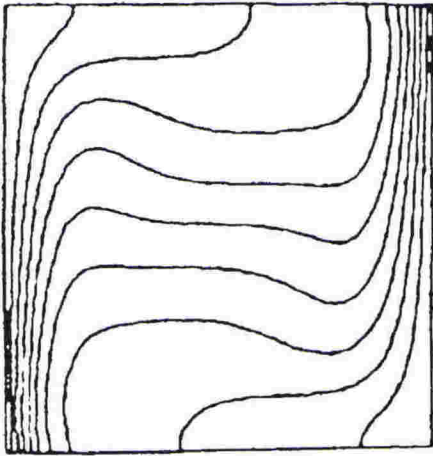

Figure 8-15 Non-dimensional temperature plot in a two-dimensional vertical square with $Ra=10^5$ (after deVahl Davis).

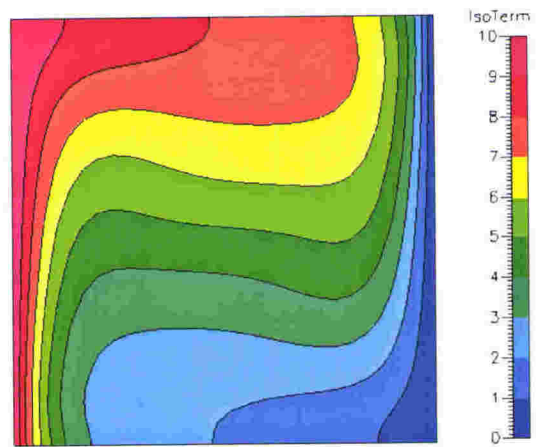

Figure 8-14 Non-dimensional temperature plot in a square with $Ra=10^5$ (calculated by CFD-ACE).

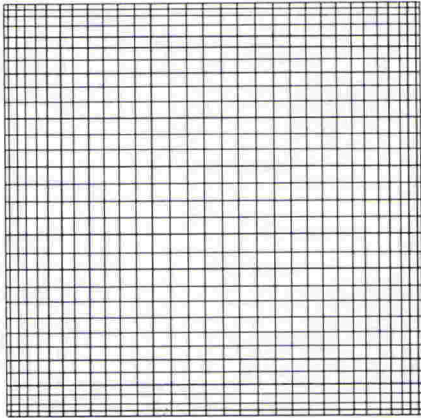

Figure 8-17 Non-uniform grid design for the two-dimensional square generated by CFD-GEOM based on structured grid system.

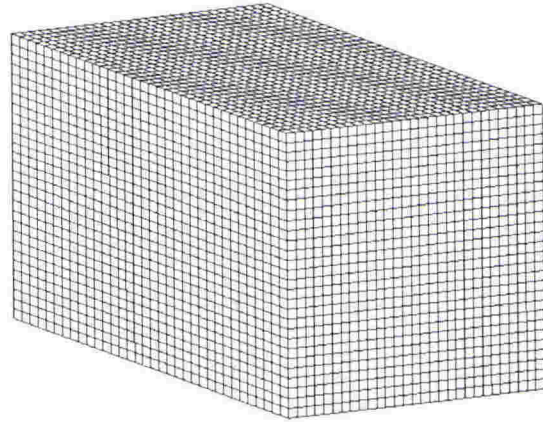
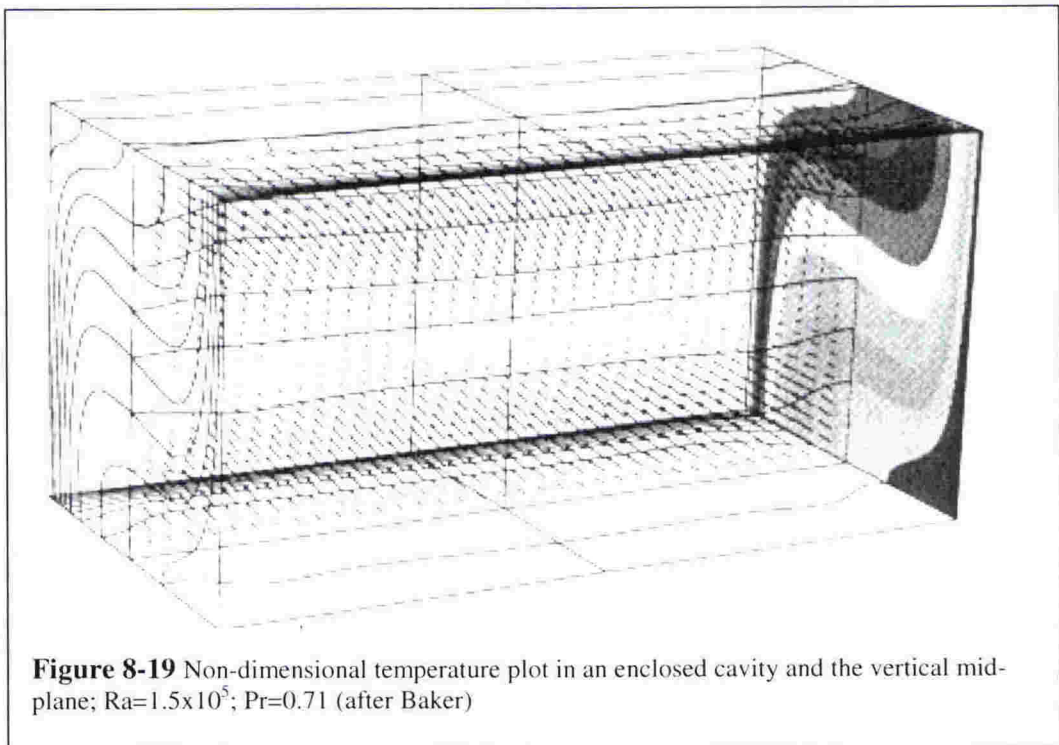
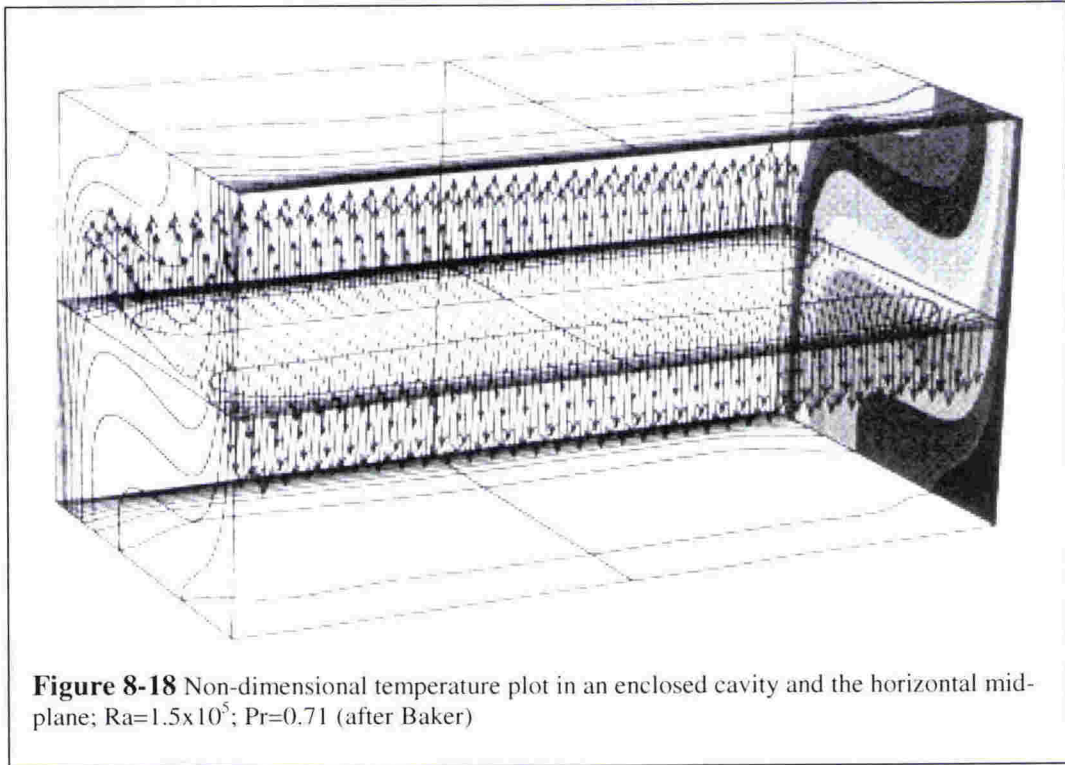
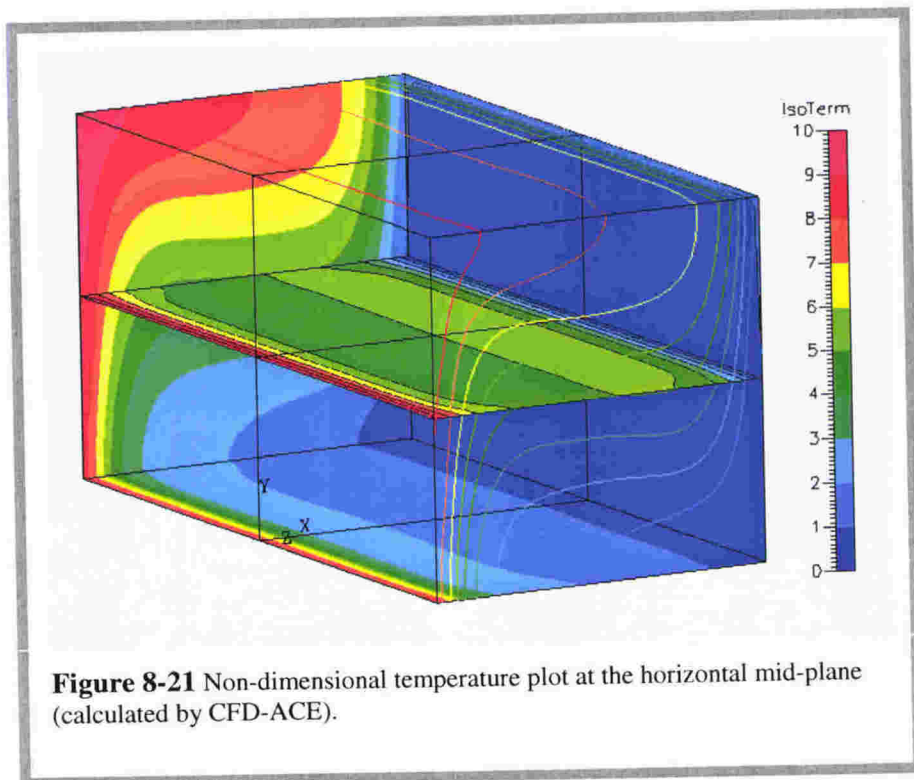
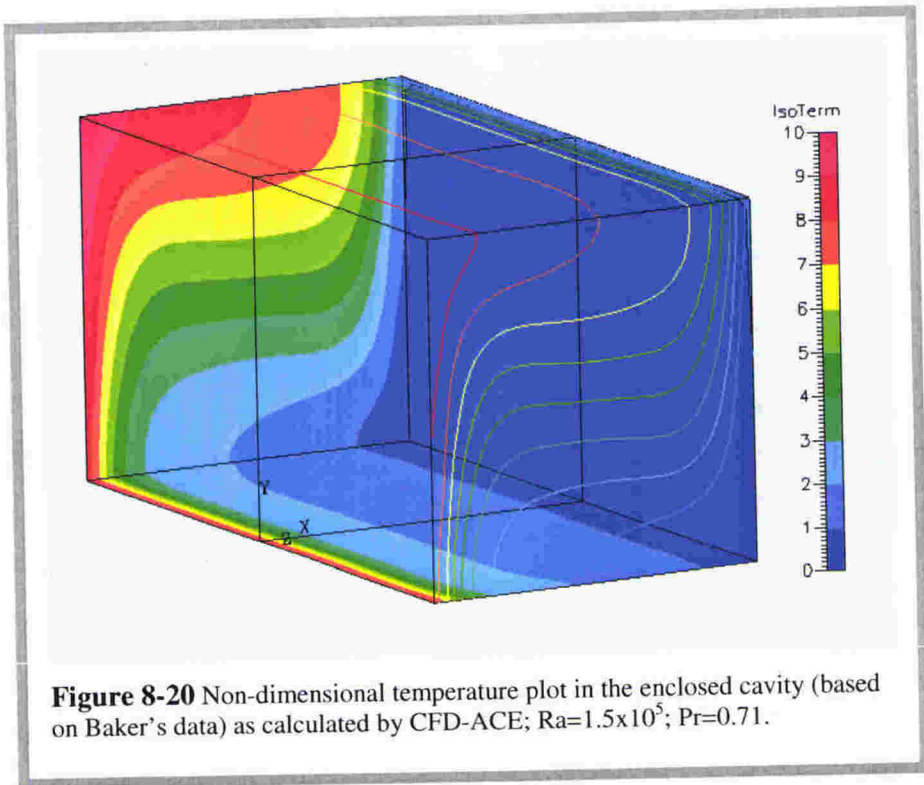
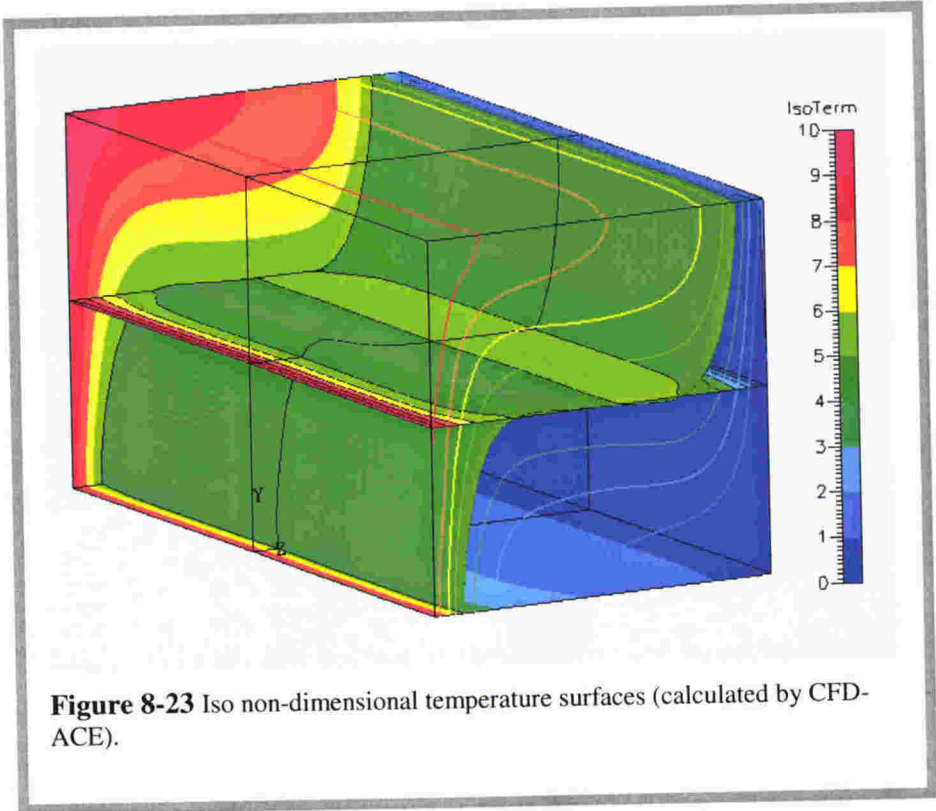
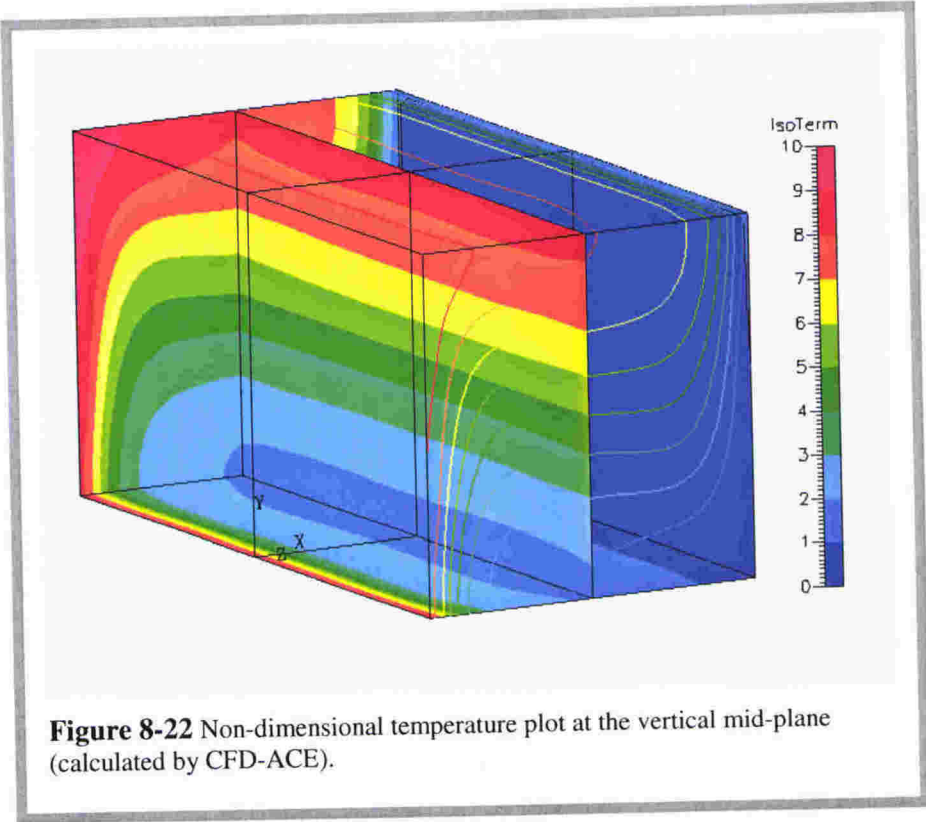

Figure 8-16 Uniform grid design for the enclosed cavity generated by CFD-GEOM based on structured grid system.







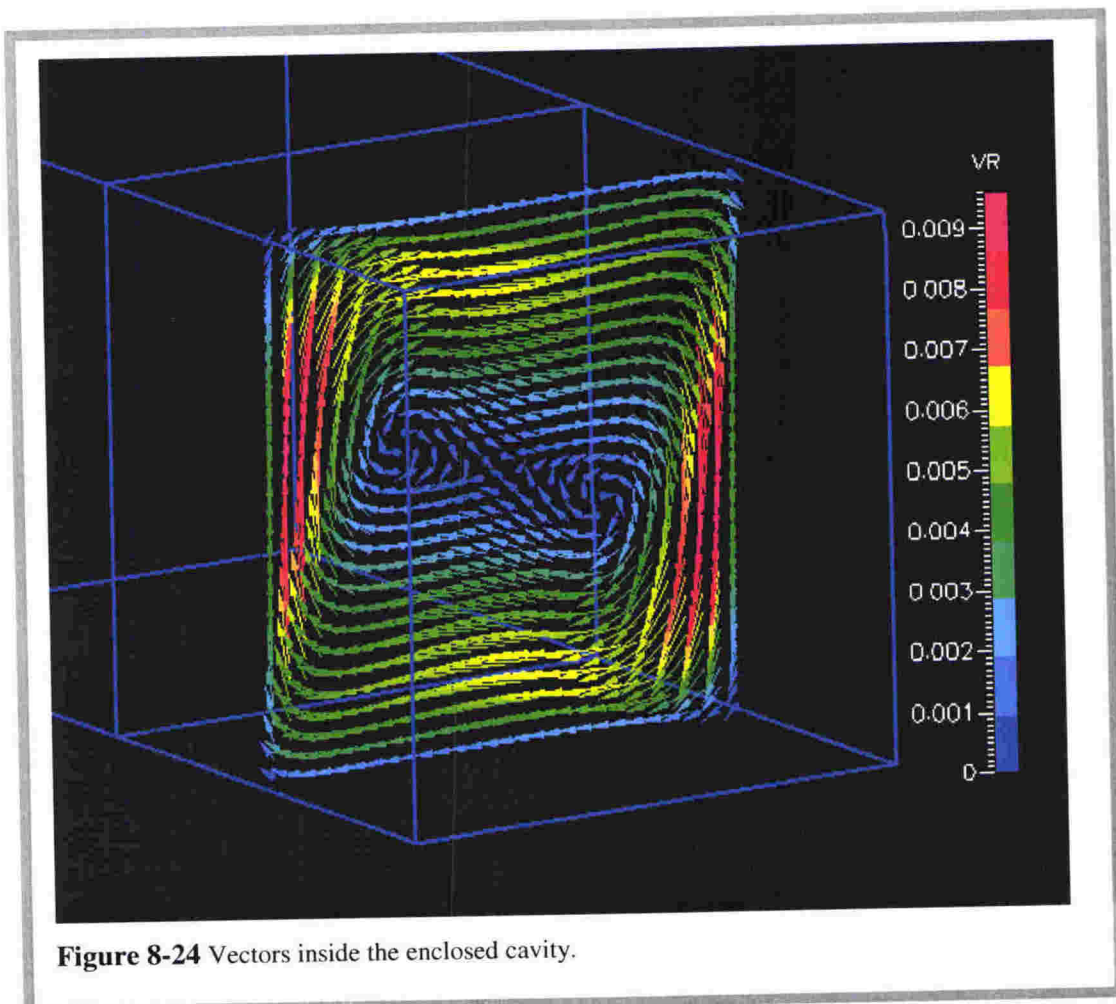
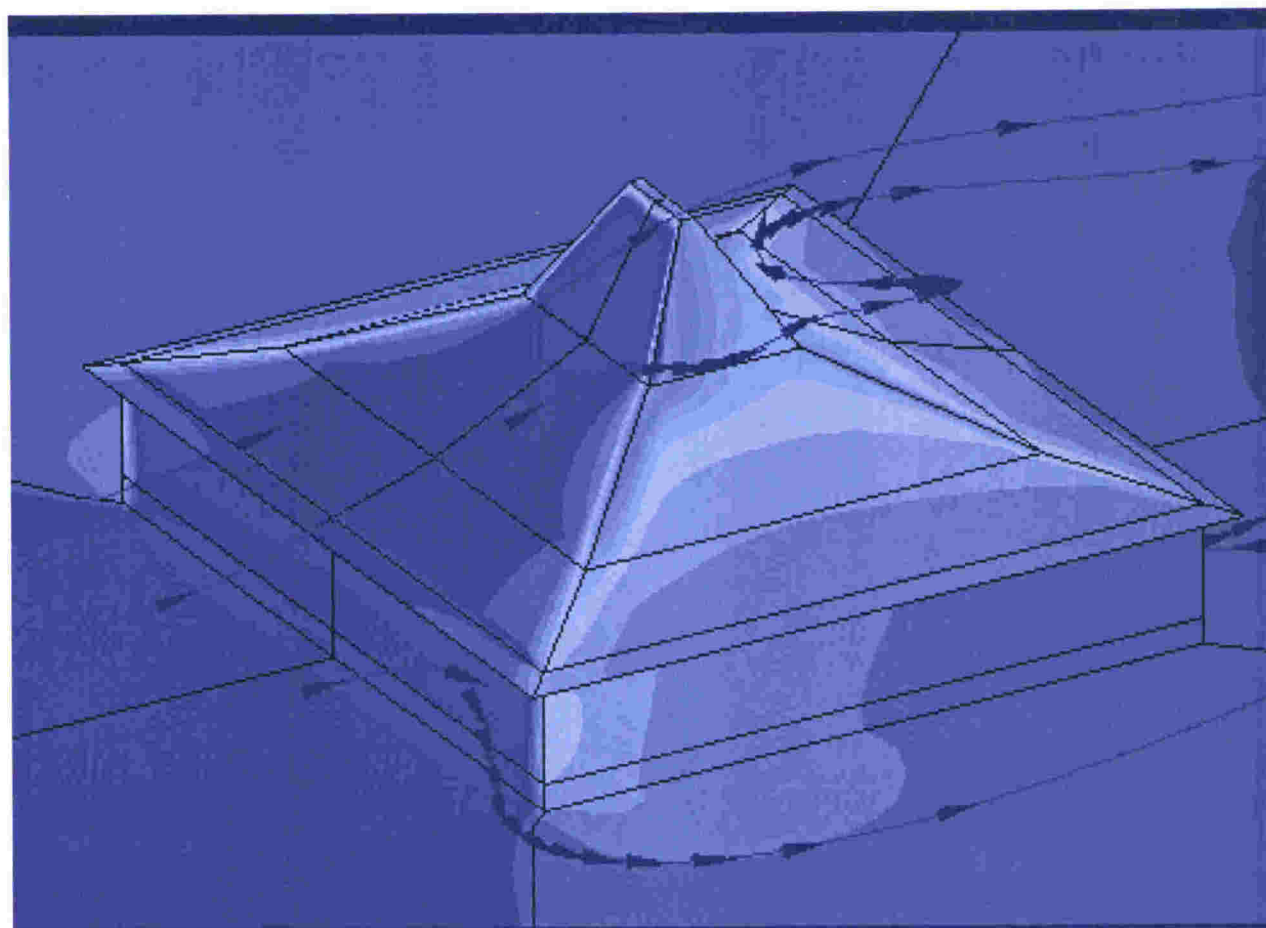
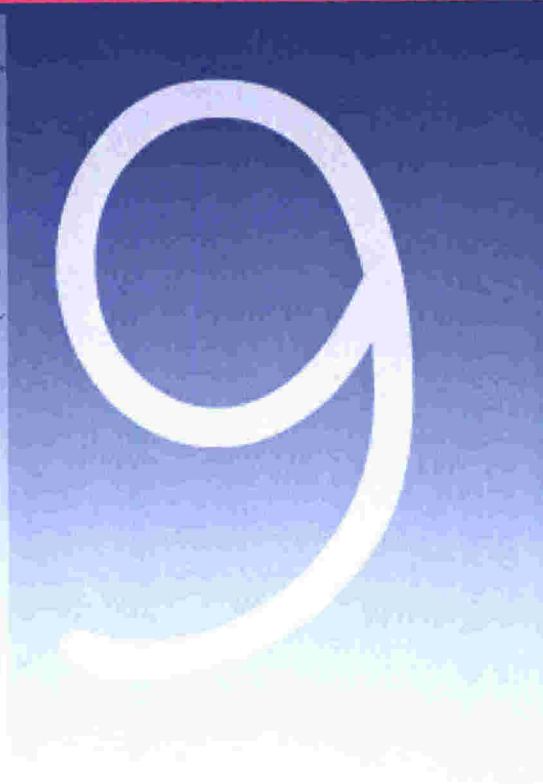

Figure 8-24 Vectors inside the enclosed cavity.



Handwritten text in a cursive script, likely a historical document or manuscript. The text is written in a dark ink on a light background. The script is dense and appears to be a form of shorthand or a specific dialect. The text is arranged in several lines, with some words appearing to be larger or more prominent than others. The overall appearance is that of a historical document or a manuscript page.



9. JAVANESE BUILDINGS AND AERODYNAMICS PERFORMANCE

9.1 Introduction

This chapter presents and discusses the results of experiments on the aerodynamic performance of Javanese buildings. The tests observed the airflow pattern around Javanese buildings and the resulting pressures on their surfaces. The results of this experiment, the pressure values, were used as inputs for thermal comfort performance studies of Javanese buildings (discussed in the next chapter).

9.2 Model Selection

Table 4.2 (Forms of Javanese Buildings) shows various styles of Javanese architecture. As has been discussed previously, this research is focused on *Joglo* and *Limasan* styles. These two styles are the most common residential Javanese buildings, in particular, for *lurah* level.

For this experiment, simple variants of *Joglo* and *Limasan* presented by Prijotomo¹ were developed. The only practical consideration behind this selection is that Prijotomo had specified the dimensions of *Joglo* (with *kitri*) and *Limasan* (with *sri*). Two other models were built based on those two styles by applying different *petungan* values. From *Joglo kitri* and *Limasan sri* can be derived, *Joglo sri* and *Limasan kitri*. Even though the *Joglo* and *Limasan*, which are available in Prijotomo's book, are simple variants, they are relatively large in dimension and probably were used as royal buildings. Smaller versions of *Joglo* and *Limasan* (as commonly used by *lurah*) were also studied. These smaller versions were developed from the basic form of *Joglo* and *Limasan* (see Table 4.2) by adding a *pananggap* sector. Thus, the larger version has a three-levelled roof form, whereas the smaller version has a two-levelled roof form. For comparison, two simple form buildings (a large hipped roof and a small hipped roof) were built. These two buildings do not apply *petungan* in their dimensions and do not use clay tiles. They were designed according to present common practices, where functionality and cost are the major considerations in building a basic house; they have the simple forms, functional dimensions (i.e., no spiritual values), and use inexpensive materials (eg. corrugated steel).

In this experiment, the change from *sri* to *kitri*, or vice versa, was done by changing the length of *blandar pamanjang* and *blandar panyelak* of the *guru* sector. This action reflects the

assumption that *petungan* is primarily applied at *guru* sector. The pitches of the roofs were unchanged. It should be noted the terms *Joglo sri* and *Joglo kitri* (as well as *Limasan sri* and *Limasan kitri*) do not exist in the real world. The term *Joglo kitri*, for example, is used here to simply indicate a *Joglo* type, which applies *kitri* as its *petungan* value.

9.3 Geometry

The construction of the model geometries was guided by results of the aerodynamic calibration tests discussed in Chapter Eight. These tests determined suitable distances between *inlet* and *outlet* in the CFD flow and the building model. They also established suitable turbulence models.

The scenarios were based on the detailed discussion in Chapter Six. Each scenario combines parameters of atmospheric, geographic and human factors. There are potentially an infinite number of scenarios depending on the values assigned to each of those parameters. As a simplification, average values were used as showed by Table 9-1. (This scenario was also used for the subsequent thermal performance experiment.) For each large version model (approximately 101,000 cells), the calculation took at least six hours to converge. (CFD-ACE uses iteration calculation to solve the non-linear equations. This involves a huge number of individual calculations until all the equations are fulfilled. The CFD-ACE writers suggest that a calculation can be considered to have a good convergence if it can reach at least four to five order lower residual numbers relative to the initial values.)

The experiment tested eight models of Javanese buildings and two models of hip roofed buildings. It hoped to show the effect of different *petungan* (ie. *kitri* and *sri*) and styles (*Joglo* and *Limasan*) on the aerodynamic performance of the buildings. The eight models of Javanese buildings were:

- Large version (three-levelled roof) of :
 - *Joglo sri*
 - *Joglo kitri*
 - *Limasan sri*
 - *Limasan kitri*

(Note: This version is based on data found in Prijotomo's book.)

- Small version (two-levelled roof) of
 - *Joglo sri*
 - *Jogloi kitri*
 - *Limasan sri*
 - *Limasan kitri*

Table 9-1 Scenario.

Atmospheric/climatic			Topography/geography			Human		
The sun radiation intensity, W/m ²	Minimum, cloudy	360	Ground roughness height	Stands alone surrounded by paddy field, terrain category 2	0.03	Clothing values, clo	Minimal; Bare chest, shorts, bare feet	0.1
	Average, scattered clouds	540		Surrounded by woods, terrain category 3	0.3		Average; typical tropical clothing ensemble	0.3
	Maximum, clear sky	1000		In the city, surrounded by multi-level buildings, terrain category 4	3		Maximum; light summer clothing	0.4
Air temperature, °C	Minimum	20	Atmospheric boundary layer, thickness, m	Stands alone surrounded by paddy field, terrain category 2	300	Metabolic rate, met	Minimum; sleeping soundly	0.8
	Average	27		Surrounded by woods, terrain category 3	400		Average; relax, reading, chatting	1.0
	Maximum	34		In the city, surrounded by multi-level buildings, terrain category 4	500		Maximum; sedentary work,	1.2
Air velocity, m/s	Minimum, calm	0						
	Average, normal	3.53						
	Maximum, windy	5.56						
Air humidity, %	Minimum, noon, bright sun	70						
	Average	80						
	Maximum, morning or after raining	90						
Wind direction, degree from the north	Minor, the third most frequent direction	180						
	Average, the second most frequent direction	210						
	Major, the most frequent direction	240						
Sky conditions, estimated duration of constant solar radiation, hour	Heavy overcast cloud	0						
	Normal, intermittent cloud	1						
	Clear sky	2						

Table 9-2 The models.

<i>Joglo</i>		<i>Limasan</i>		Hipped roof
<i>sri</i>	<i>kitri</i>	<i>sri</i>	<i>kitri</i>	
External	External	External	External	External
Case-A1S Case-A1L	Case-A2S Case-A2L	Case-A3S Case-A3L	Case-A4S Case-A4L	Case-A5#1S Case-A5#1L Case-A5#2S Case-A5#2L

Note: Case-A1S(mall version); CaseA1L(arge version)

Since *Joglo* and *Limasan* are symmetrical (as are mostly other Javanese buildings), only half the building has to be modelled. This rule, however, is only applicable if airflow is perpendicular to the building. For oblique airflow, the model should be constructed in full.

For the pilot experiments a lower grid resolution was used. A higher grid resolution was used after the experiments using the first settings showed no error in the data input. The experiment Case-A1L, for example, used about 101,232 grid cells for the higher grid resolution. For the lower grid resolution it used 34,328 grid cells.

Table 9-3 lists the model dimensions. *Joglo kitri* (L) and *Limasan sri* (L) are based on data found in Prijotomo's book². *Joglo sri* (L) was constructed by reducing the dimension of *Joglo kitri* (L)'s *guru* sector by one foot (from 17'x12' to 16'x11'). Other dimensions were conserved. *Limasan kitri* (L) was constructed by increasing the dimension of *Limasan sri* (L)'s *guru* sector by one foot (from 26'x16' to 27'x17'). The small buildings were constructed by reducing the *guru* sector dimension of their large building counterparts by five feet (one cycle of *petungan*) and eliminating the *panitih* sectors. Thus, the dimension of *Joglo kitri* (S)'s *guru* sector (12'x7') was defined by subtracting the dimension of *Joglo kitri* (L)'s *guru* sector by five feet (from 17'x12' to 12'x7').

9.4 Boundary condition

Applying the atmospheric boundary layer to the aerodynamic calibration showed that it gave better results. In this experiment, the reference velocity (V) was 3.53m/s. This is the average wind speed in Yogyakarta Special Region. Atmospheric boundary layer profile (constructed according to the power law³) and roughness height (of terrain category 3)⁴ were applied to the incoming wind and ground surface (see Figure 9-1). This modelled the incoming wind to be as real as possible. This experiment did not involve any heat transfer processes. Three phenomena were observed: patterns of airflow, wind velocity and pressure coefficients (C_p).

Table 9-3 Dimension of models.

Type	Petungan	Molo	Blandar/tumpang guru		blandar pananggap		Blandar panitih/emper		saka guru	saka pananggap	saka panitih	ander
			pamanjang	panyelak	pamanjang	panyelak	pamanjang	panyelak				
Joglo (L)	sri	7'	16'	11'	41'	36'	57'	52'	17'	11'	8'6"	9'1"
	kitri	7'	17'	12'	id.	id.	id.	id.	id.	id.	id.	id.
Limasan (L)	sri	12'	26'	16'	50'	30'	61'	52'	14'	10'4"	7'4"	8'1"
	kitri	12'	27'	17'	id.	id.	id.	id.	id.	id.	id.	id.
Hipped roof (L)	N/A		Wall's heightxlengthxwidth = 8'9"x52'7"x46'; roof pitch #1 = 26° #2 = 34°									
Joglo (S)	sri	7'	11'	6'	27'	22'	N/A	N/A	11'5"	7'6"	N/A	4'2"
	kitri	7'	12'	7'	27'	22"	N/A	N/A	11'2'	7'6"	N/A	4'11"
Limasan (S)	sri	12'	21'	11'	31'	21'	N/A	N/A	9'2"	7'6"	N/A	5'5"
	kitri	12'	22'	12'	31'	21'	N/A	N/A	9'	7'6"	N/A	5'11"
Hipped roof (S)	N/A		Wall's heightxlengthxwidth = 7'5"x25'x19'8"; roof pitch #1 = 26° #2 = 34°									

Note: The dimensions of *Joglo kitri* (L) and *Limasan sri* (L) are based on data found in Prijotomo's book⁵. The application of *petungan* is mandatory for *guru* sectors.

9.5 Flow domain

The flow domain was defined as occupied by turbulent airflow with an atmospheric boundary layer. The turbulent kinetic energy (k) and turbulent energy dissipation rate (ϵ) were calculated using the same method as presented in Chapter Eight. To reduce the manual calculation in CFD-ACE, instead of manually calculating the value of ϵ , the length of the diagonal of the inlet can be used. The atmospheric boundary was defined based on terrain category 3 (suburban areas, small towns, and well-wooded areas).

9.6 The Experiment

Data input for this experiment:

- Scenario: Scenario as seen in Table 9-1. This scenario reconstructs a normal day situation both inside (i.e. the occupants) and outside (ie. the environment) the building by combining certain parameters (represented by the shaded cells). In this experiment, the building's short axis was aligned to the wind. This was to reduce the calculation time and memory space, as only the half-model was required.
- Air properties for air temperature at 27°C: conductivity (k)=0.0267 W/mK; density(ρ)=1.177kg/m³
- Gravity: -9.8 m/s²

Table 9-4 shows some of the models used by CFD-ACE to calculate the external airflow around the Javanese buildings. This table also shows the locations of the points of maximum positive and negative pressures. Some points are at the building construction frame. This makes the ventilation potential unusable, as it is difficult to place openings at those positions. It should be noted that not all of the models are presented here, as some of them are effectively duplicated. The *Joglo kitri* (large version), for example, has the same points as the *Joglo sri* (large version). They only have a small difference in the dimension of their *guru* sector. Also, hipped roofs were built in different pitches, 26° and 34°. Only the latter is presented in Table 9-4

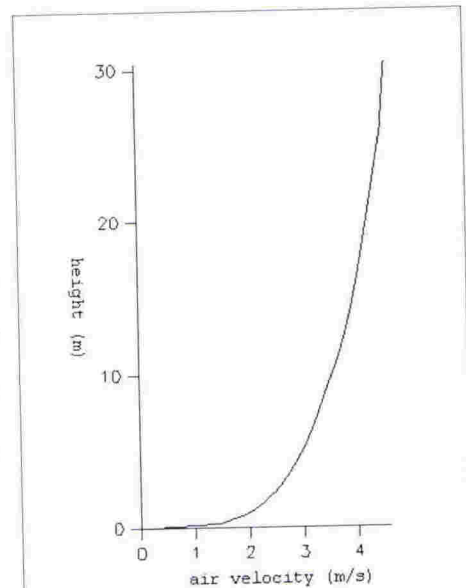
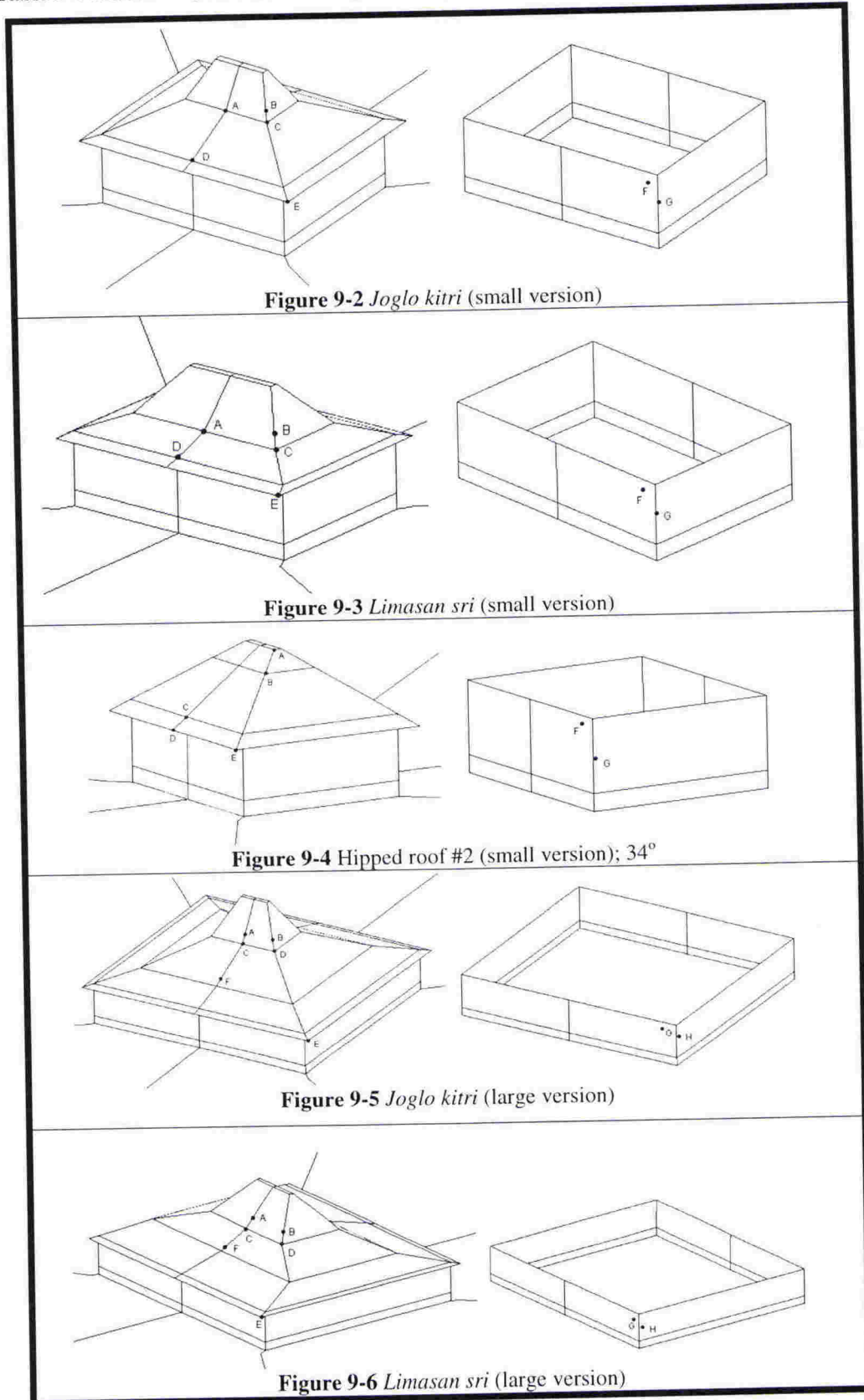
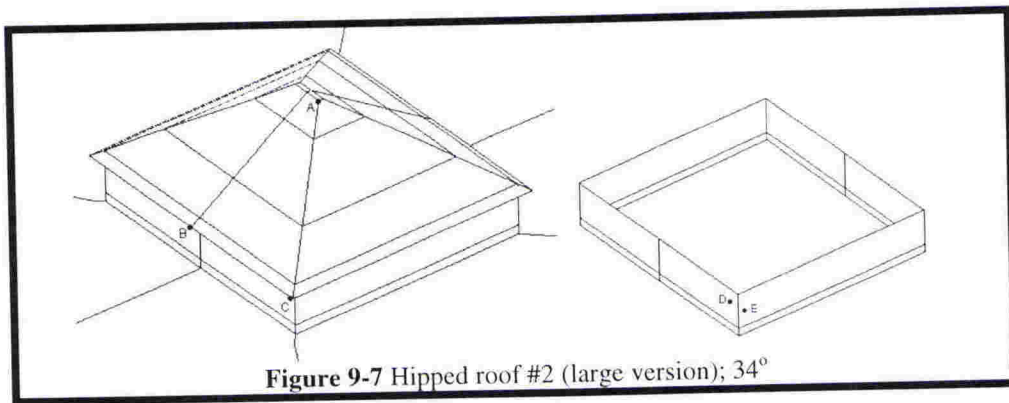

Figure 9-1 Atmospheric boundary layer generated by CFD-ACE to simulate a realistic wind profile around Javanese buildings. It was based on terrain category 3.

Table 9-4 Models of Javanese buildings and important points (generated by CFD-GEOM).





The following tables show comparison of:

- Javanese building small version (Table 9-6)
 - *Joglo sri*
 - *Joglo kitri*
 - *Limasan sri*
 - *Limasan kitri*
 - Hipped roof #2

This table gives detailed findings of the experiment results with the small version model. It presents the external airflow patterns, the pressures on the building surfaces, etc. The four models were also compared to the simple hipped roof.

- Javanese building large version (Table 9-7)
 - *Joglo sri*
 - *Joglo kitri*
 - *Limasan sri*
 - *Limasan kitri*
 - Hipped roof #2

This table has actually the same format as Table 9-6 except that it reports the experiment with the large version models.

Some of the information in those tables should be read carefully. The maximum negative pressures at the corners, for example, can be misleading. Preliminary studies found that CFD-ACE sometimes under- or over-estimate these values. To avoid inaccuracy, these unrealistic values were not included in calculations to find average values.

Table 9-6 and Table 9-7 present detailed information based on the post-processing of the CFD-ACE results and compare the findings between models. These tables have 14 items to

observe and compare. They are divided into two fields: the roof and the walls. Each area is studied for its airflow patterns and pressure coefficients. Figure 9-8 presents a comparison of pressure coefficient difference at roof level. This aids understanding of Item 13 of Table 9-6 to Table 9-8.

Table 9-5 Items of observation.

		Items	Comments
1	Roof	Positive-negative pressure distribution	To study the distribution of the pressures on the roof surfaces. The pressure and suction locations are useful to predict the direction of airflow through the linear gaps.
2		Maximum positive and negative pressure at the roof	To study if the forms of the building affect the location and magnitude of positive and negative pressure coefficients.
3		Maximum ΔC_p at roofs	To study the maximum pressure coefficient difference which occurs at roof level, its location and magnitude. It will show the possible flow path that will occur between the lowest and the highest C_p .
4		Average C_p at the roof	To study the average pressure coefficient on the roof surfaces (windward, side and leeward).
5		Airflows pattern around the roof	To study the pattern of the airflow around the roof.
6		Air speed around the roof	To study the air speed around the roof.
7	Wall	Positive-negative pressure distribution at walls	(Basically, item 7 to 12 are similar to item 1 to 6 applied at wall level)
8		Maximum positive and negative pressure at the walls	
9		Maximum ΔC_p at walls	
10		Average C_p at walls	
11		Airflows pattern around the walls	
12		Air speed around the walls	
13		Possible maximum ΔC_p at roof, based on average C_p	To study the potential of ventilation through the roof's pores.
14		Possible maximum ΔC_p between roof and walls, based on average C_p	To study the potential of ventilation between the walls and the roof if there is ceilings. This shows the ventilation potentiality if the walls are also porous.

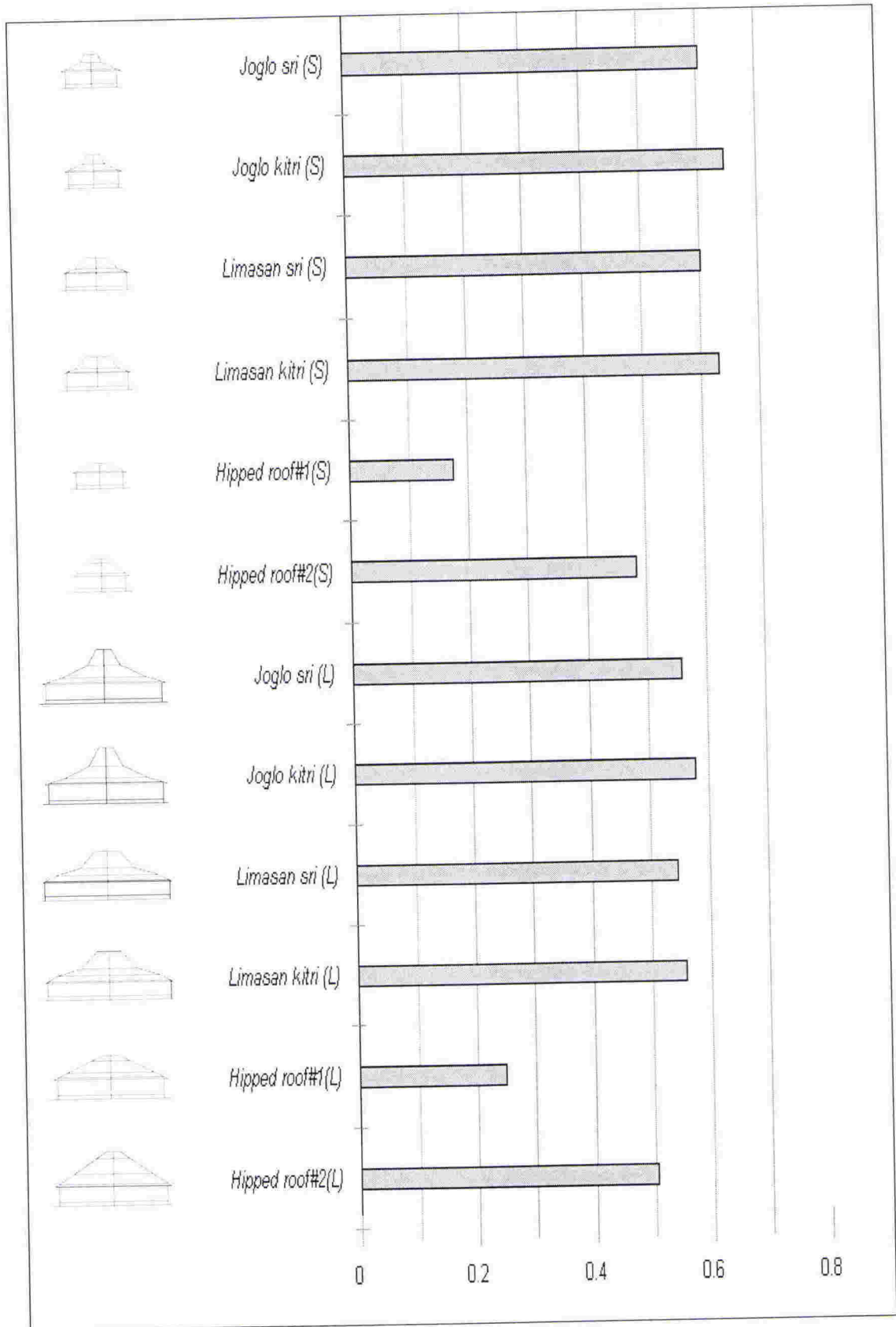

Figure 9-8 Comparison of Pressure Coefficient difference (ΔC_p) at roof level. ΔC_p of *Joglo* is higher than that of *Limasan*; ΔC_p of *kitri* is higher than that of *sri*. The differences are insignificant. Small Javanese buildings have higher ΔC_p than their large counterparts. Small-hipped roof buildings (non-Javanese styles)

have lower ΔC_p than large-hipped roof buildings do. For hipped roof buildings, smaller pitch means lower ΔC_p .

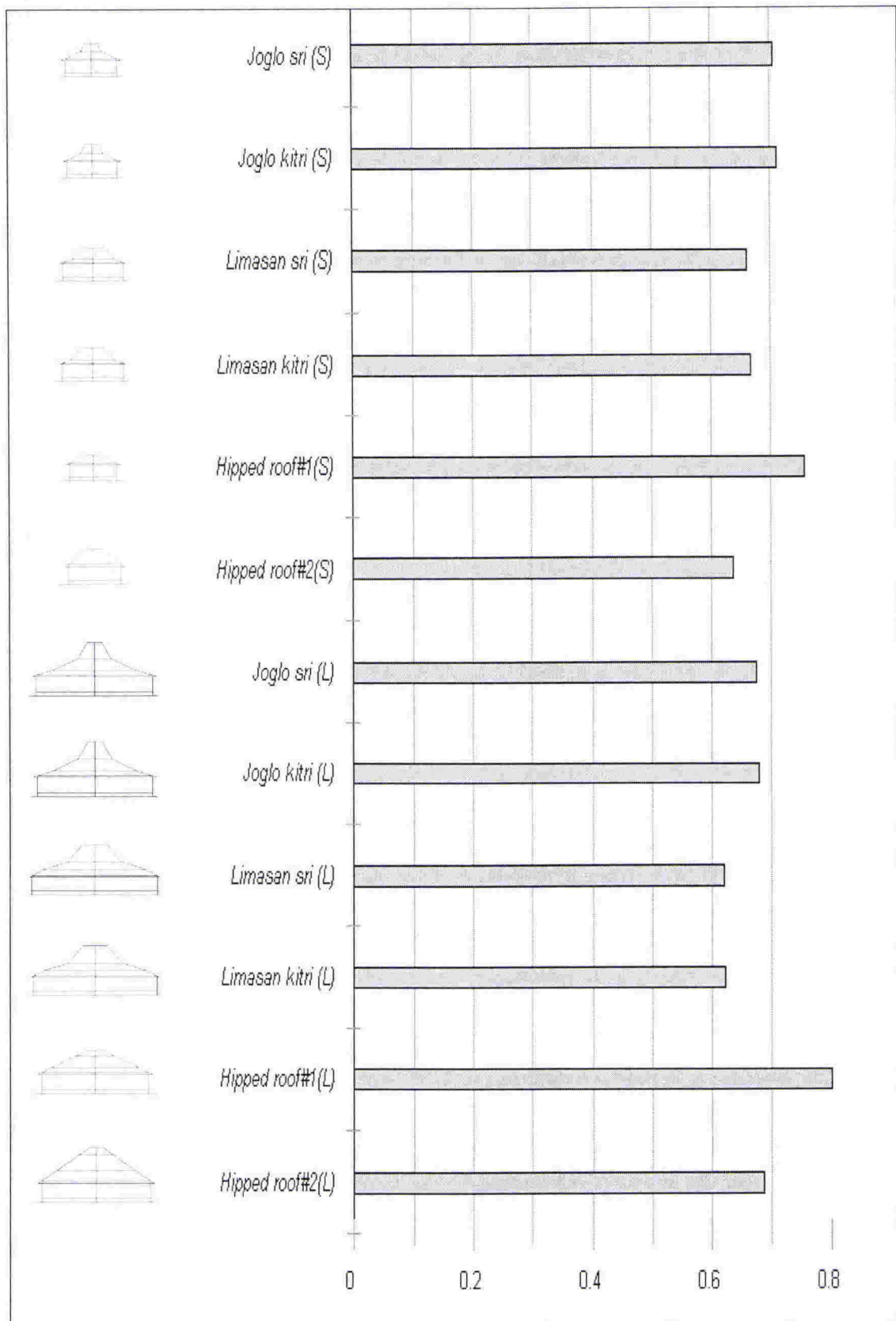

Figure 9-9 Comparison of Pressure Coefficient difference (ΔC_p) between roof and wall level. Small-pitched hipped roof buildings have the highest ΔC_p .

Table 9-6 Comparison between *Joglo*, *Limasan* and the hipped roof; small version.

	Joglo sri (Case-A1S) see Figure 9-2	Joglo kitri (Case-A2S) see Figure 9-2	Limasan sri (Case-A3S) see Figure 9-3	Limasan kitri (Case-A4S) see Figure 9-3	Hipped roof #1 (Case-A5#1S) see Figure 9-4	Comments
Roof Positive- negative pressure distribution	<i>Ngajeng</i> (front/windward); see <i>Joglo kitri</i> . <i>Tengen</i> (right hand side); see <i>Joglo kitri</i> . <i>Wingking</i> (rear, leeward); see <i>Joglo kitri</i> .	<i>Ngajeng</i> (front/windward); Positive pressures at the centre of windward side, becoming negative towards the hip; pressure increment at windward roof side (from the eaves towards the ridge) is not linear, small spots with slightly higher pressures occur at point A and D. <i>Tengen</i> (right hand side): Entire surfaces under negative pressures with higher negative pressures toward the ridge. <i>Wingking</i> (rear, leeward): Entire surfaces under negative pressures with higher negative pressures toward the ridge. Hips have negative pressures.	<i>Ngajeng</i> (front/windward); see <i>Joglo kitri</i> . <i>Tengen</i> (right hand side); See <i>Joglo kitri</i> . <i>Wingking</i> (rear, leeward); See <i>Joglo kitri</i> .	<i>Ngajeng</i> (front/windward); see <i>Joglo kitri</i> . <i>Tengen</i> (right hand side); see <i>Joglo kitri</i> . <i>Wingking</i> (rear, leeward); see <i>Joglo kitri</i> .	<i>Ngajeng</i> (front/windward); Positive pressure at windward side, becoming negative toward the roof hip and the ridge; the pressure decrement at windward roof side (from the eaves towards the ridge) is linear. <i>Tengen</i> (right hand side): see <i>Joglo kitri</i> . <i>Wingking</i> (rear, leeward): see <i>Joglo kitri</i> .	Javanese buildings have almost the same positive- negative pressure distrib- ution on the roof surfaces. Slope changes result in higher pressures around the folded lines on the windward side. This phenomenon does not occur in the hipped roof. For all buildings, only the windward surfaces are under positive pressure. Ridges and hips are locations of high negative pressures.
Maximum positive and negative pressure at the roof	Maximum positive and negative pressure found at point A ($C_p = -0.377$) and B ($C_p = -1.771$) at <i>guru</i> sector. Excluding the <i>guru</i> sector, the maximum negative pressure is found at point C ($C_p = -1.721$); The overhang has $C_p = -0.24$ at point E.	Maximum positive and negative pressure found at point A ($C_p = 0.402$) and B ($C_p = -1.758$) at <i>guru</i> sector. Excluding the <i>guru</i> sector, the maximum negative pressure is found at point C ($C_p = -1.716$); The overhang has $C_p = -0.24$ at point E.	Maximum positive and negative pressure found at point A ($C_p = 0.227$) and B ($C_p = -1.243$) at <i>guru</i> sector. Excluding the <i>guru</i> sector, the maximum negative pressure is found at point C ($C_p = -0.819$); The overhang has $C_p = -0.211$ at point E.	Maximum positive and negative pressure found at point A ($C_p = 0.260$) and B ($C_p = -1.256$) at <i>guru</i> sector. Excluding the <i>guru</i> sector, the maximum negative pressure is found at point C ($C_p = -0.827$); The overhang has $C_p = -0.288$ at point E.	Maximum positive pressure occurs at <i>pananggap</i> sector, point B ($C_p = 0.079$), maximum negative pressure at point A ($C_p = -1.425$) The corner of the overhang has $C_p = -0.031$	Javanese building have their maximum positive C_p at point A of <i>guru</i> sectors. <i>Joglo</i> and <i>kitri</i> have higher positive C_p than, respectively, <i>Limasan</i> and <i>sri</i> . The difference is insignificant. There is no obvious pattern of negative C_p . Javanese buildings have higher C_p than the hipped roof building.

3	Maximum ΔC_p at roofs	Between point A and B ($\Delta C_p=2.148$) Excluding guru sector, between point A and C ($\Delta C_p=2.098$)	Between point A and B ($\Delta C_p=2.160$) Excluding guru sector, between point A and C ($\Delta C_p=2.118$)	Between point A and B ($\Delta C_p=1.47$) Excluding guru sector, between point A and C ($\Delta C_p=1.046$)	Between point A and B ($\Delta C_p=1.516$) Excluding guru sector, between point A and C ($\Delta C_p=1.087$)	between point A and B ($\Delta C_p=1.504$)	<i>Joglo</i> and <i>kitri</i> have higher ΔC_p than, respectively, <i>Limasan</i> and <i>sri</i> .
4	Average C_p at the roof	Windward $C_p = 0.222$ Sideward $C_p = -0.369$ Leeward $C_p = -0.383$	Windward $C_p = 0.261$ Sideward $C_p = -0.367$ Leeward $C_p = -0.383$	Windward $C_p = 0.122$ Sideward $C_p = -0.29$ Leeward $C_p = -0.265$	Windward $C_p = 0.158$ Sideward $C_p = -0.289$ Leeward $C_p = -0.276$	Windward $C_p = -0.281$ Sideward $C_p = -0.457$ Leeward $C_p = -0.4$	For windward sides, <i>Joglo</i> and <i>kitri</i> have higher average C_p than, respectively, <i>Limasan</i> and <i>sri</i> . Other sides do not show any obvious relation to the styles and <i>petungan</i> values. The hipped roof has negative average C_p for all its surfaces.
5	Airflows pattern around the roof	See <i>Joglo kitri</i>	Streamlined air motion on the roof surfaces; Guru sector creates <i>wind shadow</i> , results in wake formation behind the guru sector.	See <i>Joglo kitri</i>	See <i>Joglo kitri</i>	See <i>Joglo kitri</i>	All buildings show almost similar airflow pattern. Guru sectors (especially the ridges) create <i>wind shadow</i> (area with low air speed) and form vortexes (wake formation)
6	Air speed around the roof	See <i>Joglo kitri</i>	Very low velocity close to the roof surfaces as the result of the roof roughness, highest speed at the ridge.	See <i>Joglo kitri</i>	See <i>Joglo kitri</i>	See <i>Joglo kitri</i>	High air speeds occur at ridges and hips.
7	Positive-negative pressure distribution at walls	See <i>Joglo kitri</i> .	Positive pressures at the middle part of the windward wall, decreasing and becoming negative toward the corner. All other walls have negative pressure.	See <i>Joglo kitri</i>	See <i>Joglo kitri</i>	See <i>Joglo kitri</i>	The central areas of windward walls are under positive pressure. Corners, side and leeward walls are under negative pressure.

8	Maximum positive and negative pressure at the walls	Maximum positive occurs at point F ($C_p=0.489$); maximum negative pressure at point G ($C_p=-0.464$).	Maximum positive occurs at point F ($C_p=0.470$); maximum negative pressure at point G ($C_p=-0.502$).	Maximum positive occurs at point F ($C_p=0.478$); maximum negative pressure at point G ($C_p=-0.509$).	Maximum positive occurs at point D ($C_p=0.471$); maximum negative pressure at point E ($C_p=-0.477$).	Maximum positive and negative pressures found at the same positions. <i>Joglo</i> and <i>kitri</i> have higher maximum positive C_p than, respectively, <i>Limasan</i> and <i>sri</i> . There is no obvious difference in C_p between Javanese buildings and the hipped roof building.
9	Maximum ΔC_p at walls	Found between point F and G ($\Delta C_p=0.953$)	Found between point F and G ($\Delta C_p=0.972$)	Found between point F and G ($\Delta C_p=0.987$)	Found between point D and E ($\Delta C_p=0.918$)	<i>Joglo</i> and <i>kitri</i> have higher ΔC_p than, respectively, <i>Limasan</i> and <i>sri</i> . The difference is insignificant. The hipped roof building has its ΔC_p lower than Javanese buildings.
10	Average C_p at walls	Windward $C_p = 0.323$ Sideward $C_p = -0.169$ Leeward $C_p = -0.054$	Windward $C_p = 0.328$ Sideward $C_p = -0.172$ Leeward $C_p = -0.068$	Windward $C_p = 0.290$ Sideward $C_p = -0.174$ Leeward $C_p = -0.083$	Windward $C_p = 0.299$ Sideward $C_p = -0.120$ Leeward $C_p = -0.079$	For all sides, <i>Joglo</i> and <i>kitri</i> have higher average C_p than, respectively, <i>Limasan</i> and <i>sri</i> . The difference is insignificant.
11	Airflows pattern around the walls	See <i>Joglo kitri</i>	Wake formations at windward, side and leeward walls	See <i>Joglo kitri</i>	See <i>Joglo kitri</i>	All buildings have almost identical airflow patterns
12	Air speed around the walls	See <i>Joglo kitri</i>	The air speeds at the walls are relatively higher than at the roofs as the walls are less rough than the roofs.	See <i>Joglo kitri</i>	See <i>Joglo kitri</i>	All buildings have almost identical air speed distribution.
13	Possible maximum ΔC_p at roof, based on average C_p	Between windward and leeward surfaces ($\Delta C_p=0.605$)	Between windward and leeward surfaces ($\Delta C_p=0.644$)	Between windward and leeward surfaces ($\Delta C_p=0.412$)	between windward and leeward roof surfaces ($\Delta C_p=0.176$)	At roof level, <i>Joglo</i> and <i>Kitri</i> have higher possible maximum ΔC_p than, respectively, <i>Limasan</i> and <i>sri</i> (based on average C_p). The hipped roof building has lower possible maximum than Javanese buildings do.

Possible maximum ΔC_p between roof walls, and based on average C_p	Between windward wall and sidewall roof surfaces ($\Delta C_p=0.706$)	Between windward wall and leeward roof surfaces ($\Delta C_p=0.576$)	Between windward wall and leeward roof surfaces ($\Delta C_p=0.579$)	between windward wall and sidewall roof surfaces ($\Delta C_p=0.756$)	Between wall and roof level, the hipped roof building has the highest possible maximum ΔC_p than Javanese buildings do. <i>Joglo</i> and <i>kitri</i> have higher possible maximum ΔC_p than, respectively, <i>Limasan</i> and <i>sri</i> (based on average C_p).
--	---	--	--	---	--

Table 9-7 Comparison between *Joglo*, *Limasan* and the hipped roof; large version.

	<i>Joglo sri</i> (Case-A1L) see Figure 9-5	<i>Joglo kitri</i> (Case-A2L) see Figure 9-5	<i>Limasan sri</i> (Case-A3L) see Figure 9-6	<i>Limasan kitri</i> (Case-A4L) see Figure 9-6	Hipped roof#1 (Case-A5#1L) see Figure 9-7	Comments
Roof	<i>Ngajeng</i> (front/windward): see <i>Joglo kitri</i> . <i>Tengen</i> (right hand side): see <i>Joglo kitri</i> . <i>Wingking</i> (rear, leeward): see <i>Joglo kitri</i> .	<i>Ngajeng</i> (front/windward): Positive pressures at the centre of windward side, becoming negative towards the hip; pressure increment at windward roof side (from the eaves towards the ridge) is not linear, small spots with slightly higher pressures occur at point A and F. <i>Tengen</i> (right hand side): Entire surfaces under negative pressures with higher negative pressures toward the ridge. <i>Wingking</i> (rear, leeward): Entire surfaces under negative pressures with higher negative pressures toward the ridge. Hips have negative pressures.	<i>Ngajeng</i> (front/windward): see <i>Joglo kitri</i> . <i>Tengen</i> (right hand side): see <i>Joglo kitri</i> . <i>Wingking</i> (rear, leeward): see <i>Joglo kitri</i> .	<i>Ngajeng</i> (front/windward): see <i>Joglo kitri</i> . <i>Tengen</i> (right hand side): see <i>Joglo kitri</i> . <i>Wingking</i> (rear, leeward): see <i>Joglo kitri</i> .	<i>Ngajeng</i> (front/windward): Positive pressure at windward side, becoming negative toward the roof hip and the ridge; the pressure decrement at windward roof side (from the eaves towards the ridge) is linear. <i>Tengen</i> (right hand side): see <i>Joglo kitri</i> . <i>Wingking</i> (rear, leeward): see <i>Joglo kitri</i> .	Javanese buildings have almost the same positive-negative pressure distribution on the roof surfaces. Slope changes result in higher pressures around the folded lines the windward side. This phenomenon does not exist in the hipped roof. For all buildings, only the windward surfaces are under positive pressure. Ridges and hips are locations of high negative pressures.

2	Maximum positive and negative pressure at the roof	Maximum positive and negative pressure found at point A ($C_p=0.419$) and B ($C_p=-2.192$) at <i>guru</i> sector. Excluding the <i>guru</i> sector, the maximum positive pressure is found at point C ($C_p=0.339$); maximum negative pressure is at point D ($C_p=-1.712$). The overhang has $C_{pe}=-0.332$ at point E.	Maximum positive and negative pressure found at point A ($C_p=0.431$) and B ($C_p=-2.135$) at <i>guru</i> sector. Excluding the <i>guru</i> sector, the maximum positive pressure is found at point C ($C_p=0.356$); maximum negative pressure is at point D ($C_p=-1.716$). The overhang has $C_{pe}=-0.332$ at point E.	Maximum positive and negative pressure found at point A ($C_p=0.321$) and B ($C_p=-1.932$) at <i>guru</i> sector. Excluding the <i>guru</i> sector, the maximum positive pressure is found at point C ($C_p=0.287$); maximum negative pressure is at point D ($C_p=-1.373$). The overhang has $C_{pe}=-0.34$ at point E.	Maximum positive and negative pressure found at point A ($C_p=0.33$) and B ($C_p=-1.921$) at <i>guru</i> sector. Excluding the <i>guru</i> sector, the maximum positive pressure is found at point C ($C_p=0.299$); maximum negative pressure is at point D ($C_p=-1.355$). The overhang has $C_{pe}=-0.341$ at point E.	Maximum positive pressure occurs at <i>panith</i> sector, ie at the eaves ($C_p=0.176$), maximum negative pressure at the ridge ($C_p=-1.988$). The corner of the overhang has $C_{pe}=-0.381$	Javanese building have maximum positive C_p at point A of <i>guru</i> sectors. <i>Joglo</i> and <i>kitri</i> have higher positive C_p , than, respectively, <i>Limasan</i> and <i>sri</i> . The difference is insignificant. There is no obvious pattern of negative C_p . Javanese buildings have higher C_p than the hipped roof building.
3	Maximum ΔC_p at roofs	Between point A and B ($\Delta C_p=2.611$) Excluding <i>guru</i> sector, between point C and D ($\Delta C_p=2.051$)	between point A and B ($\Delta C_p=2.253$) Excluding <i>guru</i> sector, between point C and D ($\Delta C_p=1.66$)	between point A and B ($\Delta C_p=2.251$) Excluding <i>guru</i> sector, between point C and D ($\Delta C_p=1.654$)	between point A and B ($\Delta C_p=2.369$)	between point A and B ($\Delta C_p=2.369$) <i>Joglo</i> and <i>sri</i> have higher ΔC_p , than, respectively, <i>Limasan</i> and <i>kitri</i> .	
4	Average C_p at the roof	Windward $C_p=0.187$ Sideward $C_p=-0.371$ Leeward $C_p=-0.355$	Windward $C_p=0.206$ Sideward $C_p=-0.372$ Leeward $C_p=-0.36$	Windward $C_p=0.224$ Sideward $C_p=-0.299$ Leeward $C_p=-0.333$	Windward $C_p=-0.275$ Sideward $C_p=-0.523$ Leeward $C_p=-0.440$	For windward sides, <i>Limasan</i> and <i>kitri</i> have higher average C_p , than, respectively, <i>Joglo</i> and <i>sri</i> . Other sides do not show any obvious relation to the styles and <i>petungan</i> values. The hipped roof has negative average C_p for all its surfaces.	
5	Airflows pattern around the roof	See <i>Joglo kitri</i>	Streamlined air motion on the roof surfaces; <i>Guru</i> sector creates <i>wind shadow</i> , results in wake formation behind the <i>guru</i> sector.	See <i>Joglo kitri</i>	See <i>Joglo kitri</i>	All buildings show almost identical airflow pattern. <i>Guru</i> sectors (especially the ridges) create <i>wind shadow</i> (area with low air speed) and form vortices (wake formation)	
6	Air speed around the roof	See <i>Joglo kitri</i>	Very low velocity close to the roof surfaces as the result of the roof roughness, highest speed at the ridge.	See <i>Joglo kitri</i>	See <i>Joglo kitri</i>	High air speeds occur at ridges and hips.	

7	Wall	Positive-negative pressure distribution at walls	See <i>Joglo kitri</i> .	Positive pressures at the middle part of the windward wall, decreasing and becoming negative toward the corner. All other walls have negative pressure.	See <i>Joglo kitri</i>	See <i>Joglo kitri</i>	See <i>Joglo kitri</i>	The central areas of windward walls are under positive pressure. Corners, side and leeward walls are under negative pressure.
8		Maximum positive and negative pressure at the walls	Maximum positive occurs at point G ($C_p=0.521$); maximum negative pressure at point H ($C_p=-0.477$).	Maximum positive occurs at point G ($C_p=0.474$); maximum negative pressure at point H ($C_p=-0.614$).	Maximum positive occurs at point G ($C_p=0.494$); maximum negative pressure at point H ($C_p=-0.617$).	Maximum positive occurs at point D ($C_p=0.476$); maximum negative pressure at point E ($C_p=-0.347$).	Maximum positive and negative pressures found at the same positions. <i>Joglo</i> and <i>kitri</i> have higher maximum positive C_p than, respectively, <i>Limasan</i> and <i>sri</i> . There is no obvious difference in C_p between Javanese buildings and the hipped roof building.	
9		Maximum ΔC_p at walls	Found between point G and H ($\Delta C_p=0.998$)	Found between point G and H ($\Delta C_p=1.088$)	Found between point G and H ($\Delta C_p=1.111$)	Found between point D and E ($\Delta C_p=0.823$)	<i>Joglo</i> and <i>kitri</i> have higher ΔC_p than, respectively, <i>Limasan</i> and <i>sri</i> . The difference is insignificant. The hipped roof building has its ΔC_p lower than Javanese buildings.	
10		Average C_p at walls	Windward $C_p = 0.304$ Sideward $C_p = -0.134$ Leeward $C_p = -0.065$	Windward $C_p = 0.288$ Sideward $C_p = -0.129$ Leeward $C_p = -0.045$	Windward $C_p = 0.29$ Sideward $C_p = -0.13$ Leeward $C_p = -0.045$	Windward $C_p = 0.3$ Sideward $C_p = -0.145$ Leeward $C_p = -0.064$	For all sides, <i>Joglo</i> and <i>kitri</i> have higher average C_p than, respectively, <i>Limasan</i> and <i>sri</i> . The difference is insignificant.	
11		Airflows pattern around the walls	See <i>Joglo kitri</i>	Wake formations at windward, side and leeward walls	See <i>Joglo kitri</i>	See <i>Joglo kitri</i>	All buildings have almost identical airflow patterns	
12		Air speed around the walls	See <i>Joglo kitri</i>	The air speeds at the walls are relatively higher than at the roofs as the walls are less rough than the roofs.	See <i>Joglo kitri</i>	See <i>Joglo kitri</i>	All buildings have almost identical air speed distribution at their walls.	

13	Possible maximum ΔC_p at roof, based on average C_p	Between windward and side-ward surfaces ($\Delta C_p=0.558$)	Between windward and side-ward surfaces ($\Delta C_p=0.578$)	Between windward and leeward surfaces ($\Delta C_p=0.545$)	between windward and leeward roof surfaces ($\Delta C_p=0.557$)	between windward and leeward roof surfaces ($\Delta C_p=0.248$)	At roof level, <i>Joglo</i> and <i>kitri</i> have higher possible maximum ΔC_p than, respectively, <i>Limasari</i> and <i>sri</i> (based on average C_p). The hipped roof building has lower possible maximum than Javanese buildings do.
14	Possible maximum ΔC_p between roof and walls, based on average C_p	Between windward wall and sideward roof surfaces ($\Delta C_p=0.675$)	Between windward wall and sideward roof surfaces ($\Delta C_p=0.679$)	Between windward wall and leeward roof surfaces ($\Delta C_p=0.621$)	between windward wall and leeward roof surfaces ($\Delta C_p=0.623$)	between windward wall and leeward roof surfaces ($\Delta C_p=0.823$)	Between wall and roof level, the hipped roof building has the highest possible maximum ΔC_p than Javanese buildings do. <i>Joglo</i> and <i>kitri</i> have higher possible maximum ΔC_p than, respectively, <i>Limasan</i> and <i>sri</i> (based on average C_p).

Note: The pressure coefficients used in the above table are based on the velocity reference of 3.53m/s, which is the average wind speed in Yogyakarta, measured 10 meters above the ground.

Table 9-8 Comparison between 26° (#1) and 34° (#2) hipped roofs (large and small versions)

		Hipped roof #1 (Case-A5#1S) see Figure 9-4	Hipped roof #1 (Case-A5#1L) see Figure 9-4	Hipped roof #2 (Case-A5#2S) see Figure 9-7	Hipped roof #2 (Case-A5#2L) see Figure 9-7	Comments
Roof	Positive-negative pressure distribution	<i>Ngajeng</i> (front/windward): Positive pressure at windward side, becoming negative toward the roof hip and the ridge; the pressure decrement at windward roof side (from the eaves towards the ridge) is linear. <i>Tengen</i> (right hand side): see <i>Joglo kitri</i> . <i>Wingking</i> (rear, leeward): see <i>Joglo kitri</i> .	<i>Ngajeng</i> (front/windward): Positive pressure at windward side, becoming negative toward the roof hip and the ridge; the pressure decrement at windward roof side (from the eaves towards the ridge) is linear. <i>Tengen</i> (right hand side): see <i>Joglo kitri</i> . <i>Wingking</i> (rear, leeward): see <i>Joglo kitri</i> .	<i>Ngajeng</i> (front/windward): Positive pressure at windward side, becoming negative toward the roof hip and the ridge; the pressure decrement at windward roof side (from the eaves towards the ridge) is linear. <i>Tengen</i> (right hand side): see <i>Joglo kitri</i> . <i>Wingking</i> (rear, leeward): see <i>Joglo kitri</i> .	<i>Ngajeng</i> (front/windward): Positive pressure at windward side, becoming negative toward the roof hip and the ridge; the pressure decrement at windward roof side (from the eaves towards the ridge) is linear. <i>Tengen</i> (right hand side): see <i>Joglo kitri</i> . <i>Wingking</i> (rear, leeward): see <i>Joglo kitri</i> .	All buildings have almost similar positive-negative pressure distribution.
1						

2	Maximum positive and negative pressure at the roof	Maximum positive pressure occurs at panith sector, ie at the eaves ($C_p=0.176$), maximum negative pressure at point A ($C_p=-1.425$) The corner of the overhang has $C_p=-0.031$	Maximum positive pressure occurs at panith sector, ie at the eaves ($C_p=0.176$), maximum negative pressure at point A ($C_p=-1.555$) The corner of the overhang has $C_p=-0.286$	Maximum positive pressure occurs at panith sector, ie at the eaves ($C_p=0.436$), maximum negative pressure at the hip ($C_p=-1.921$) The corner of the overhang has $C_p=-0.505$	Larger scale and larger roof pitch create higher maximum pressure at windward surfaces.
3	Maximum ΔC_p at roofs	Between point A and B ($\Delta C_p=1.504$)	Between point A and B ($\Delta C_p=1.885$)	Between point A and B ($\Delta C_p=2.29$)	Larger scale creates higher maximum ΔC_p . For small-scale buildings larger roof pitch creates higher ΔC_p and vice versa for large scale buildings.
4	Average C_p at the roof	Windward $C_p = -0.281$ Sideward $C_p = -0.457$ Leeward $C_p = -0.4$	Windward $C_p = 0.149$ Sideward $C_p = -0.334$ Leeward $C_p = -0.250$	Windward $C_p = 0.148$ Sideward $C_p = -0.356$ Leeward $C_p = -0.323$	No obvious relation between scale and roof pitch and average ΔC_p .
5	Airflows pattern around the roof	Wake formation at the leeward surface only behind the ridge See <i>Joglo kitri</i>	Wake formation at the leeward surface only behind the ridge See <i>Joglo kitri</i>	Wake formation at the entire leeward surface See <i>Joglo kitri</i>	Steep roof results in backward flow on the leeward surfaces.
6	Air speed around the roof	See <i>Joglo kitri</i>	See <i>Joglo kitri</i>	See <i>Joglo kitri</i>	Ridge and hips are places for high speed.
7	Positive-negative pressure distribution at walls	See <i>Joglo kitri</i>	See <i>Joglo kitri</i>	See <i>Joglo kitri</i>	Positive pressures occur at the central areas of windward walls. Other walls are under negative pressures.
8	Maximum positive and negative pressure at the walls	Maximum positive pressure occurs at point D ($C_p=0.471$); maximum negative pressure at point E ($C_p=-0.477$) Found between points D and E ($\Delta C_p=0.918$)	Maximum positive pressure occurs at point D ($C_p=0.487$); maximum negative pressure at point E ($C_p=-0.522$) Found between points D and E ($\Delta C_p=1.009$)	Maximum positive pressure occurs at point D ($C_p=0.513$); maximum negative pressure at point E ($C_p=-0.551$) Found between points D and E ($\Delta C_p=1.064$)	Larger scale and larger roof pitches create higher maximum positive pressures.
9	Maximum ΔC_p at walls	Found between points D and E ($\Delta C_p=0.918$)	Found between points D and E ($\Delta C_p=0.823$)	Found between points D and E ($\Delta C_p=1.064$)	For small roof pitches a small scale creates a higher ΔC_p and vice versa for large roof pitches.
10	Average C_p at walls	Windward $C_p = 0.299$ Sideward $C_p = -0.120$ Leeward $C_p = -0.079$ See <i>Joglo kitri</i>	Windward $C_p = 0.361$ Sideward $C_p = -0.206$ Leeward $C_p = -0.066$ See <i>Joglo kitri</i>	Windward $C_p = 0.332$ Sideward $C_p = -0.172$ Leeward $C_p = -0.046$ See <i>Joglo kitri</i>	There is no obvious relation between the scale and the roof pitches and the average C_p .
11	Airflows pattern around the walls	See <i>Joglo kitri</i>	See <i>Joglo kitri</i>	See <i>Joglo kitri</i>	All buildings have almost similar airflow patterns with wake formation at windward, side and leeward sides.
12	Air speed around the walls	See <i>Joglo kitri</i>	See <i>Joglo kitri</i>	See <i>Joglo kitri</i>	Corners are places for high speed.

13	Possible maximum ΔC_p at roof, based on average C_p	Between windward and sideward roof surfaces ($\Delta C_p=0.176$)	between windward and sideward roof surfaces ($\Delta C_p=0.248$)	between windward and sideward roof surfaces ($\Delta C_p=0.485$)	between windward and sideward roof surfaces ($\Delta C_p=0.504$)	Larger scale and larger roof pitches create higher possible maximum ΔC_p at roof level.
14	Possible maximum ΔC_p between roof and walls, based on average C_p	Between windward wall and sideward roof surfaces ($\Delta C_p=0.756$)	between windward wall and leeward roof surfaces ($\Delta C_p=0.823$)	between windward wall and sideward roof surfaces ($\Delta C_p=0.697$)	between windward wall and leeward roof surfaces ($\Delta C_p=0.688$)	Small roof pitches create higher ΔC_p .

9.7 General Findings and Discussions

Table 9-6, Table 9-7, and Table 9-8 have given preliminary comments on the comparison between Javanese and non-Javanese buildings. It involved studies on the effect of styles, *petungan* and scales. This sub-chapter further discusses the findings by combining comments in those tables with Figure 9-8 and Figure 9-9.

- Table 9-6 and Table 9-7 show comparison of, respectively, the small and the large versions of two Javanese building styles: *Joglo* and *Limasan*. Those two tables also compare between two *petungan* values: *sri* and *kitri*. The tables show that applying *kitri* (for both *Joglo* and *Limasan*) creates higher ΔC_p than applying *sri*. Figure 9-8 graphically shows a consistent phenomenon that *kitri* creates higher ΔC_p than *sri*. If ΔC_p is seen as the potential to generate ventilation, higher ΔC_p indicates more airflow. According to *petungan*, the application of *sri* and *kitri* (see Chapter Four) is based

on the function of the building. The former is for *dalem* (private space for the family, sleeping, sitting) and the latter is for *pendapa* (semi public space, entertaining guests, etc.) It might be assumed that the *dalem* is for lower levels of activity (and less people) than the *pendapa*, thus

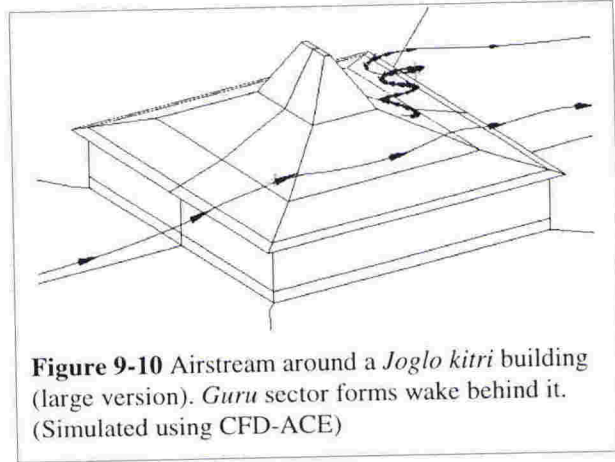

Figure 9-10 Airstream around a *Joglo kitri* building (large version). *Guru* sector forms wake behind it. (Simulated using CFD-ACE)

generating a different ventilation requirement for *pendapa*. (Note: This argument is only true for enclosed *pendapas*. Most *pendapas* do not have walls.) In terms of magnitude, however, the difference of ΔC_p (between applying *kitri* and *sri*) is very small, ~ 0.025 .

- Joglo* has higher ΔC_p than *Limasan*. The difference is small, ~ 0.01 .
- Small versions of *Joglo* and *Limasan* have higher ΔC_p than their large version counterparts. The difference is small, ~ 0.06 .
- In general, the patterns of the external airflows around *Joglo kitri*, *Joglo sri*, *Limasan sri* and *Limasan kitri* are almost the same. Wake formations

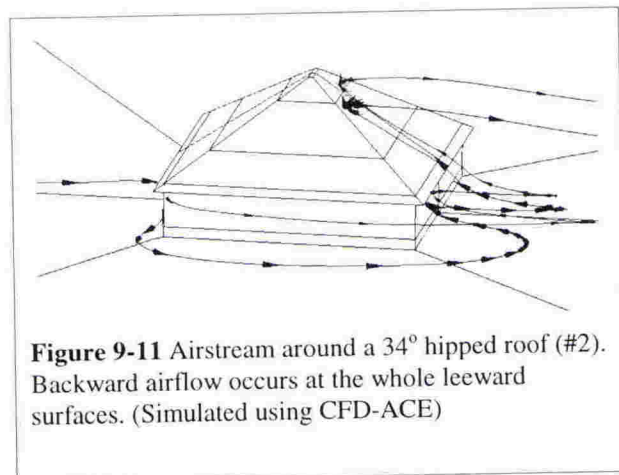

Figure 9-11 Airstream around a 34° hipped roof (#2). Backward airflow occurs at the whole leeward surfaces. (Simulated using CFD-ACE)

exist at the leeward walls, sidewalls and at the leeward roof behind the *guru* sectors. (see Figure 9-10) The hipped roof #2 (see Figure 9-11) has an almost identical airflow pattern

except that the wake exists at all the rear roof side, not only behind the ridge (or *guru* sector at *Joglo* and *Limasan* styles). The slope of the roof influences the wake formation. The smaller the slope the weaker the wake formation. Figure 9-12 shows that wake formation does not occur behind the 26° hipped roof.

- In all *Joglo* and *Limasan* roofs, *guru* sectors create vortices behind them. At the 34° hipped roof, the wind flows backward in all the leeward side. The absence of backward airflow at the leeward roofs (excepts behind the *guru* sector) might induce the indoor air to flow out easier because the gaps between clay tiles face downward.

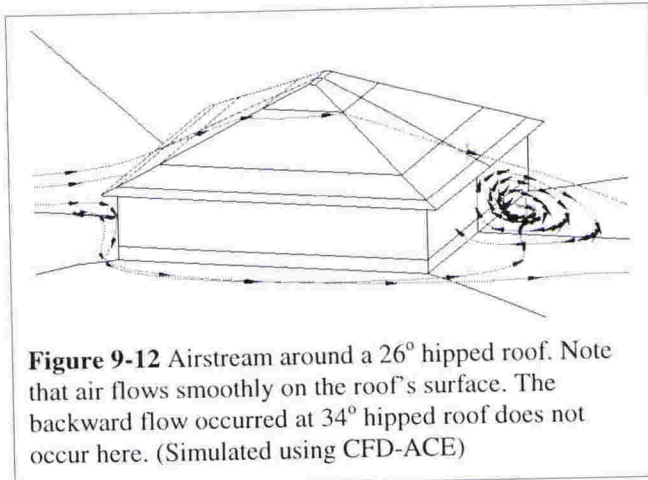

Figure 9-12 Airstream around a 26° hipped roof. Note that air flows smoothly on the roof's surface. The backward flow occurred at 34° hipped roof does not occur here. (Simulated using CFD-ACE)

- At roof level, *Joglo* and *Limasan*, have their maximum positive and negative C_p at points A (at *guru* sector) and B (see Figure 9-2 and Figure 9-3). The hipped roof has its maximum positive and negative C_p at points A (at the overhang) and B (see Figure 9-4). For the whole building, however, the maximum positive C_p is found near the top of the windward walls (at point G for *Joglo* and *Limasan* or at point D for the hipped roof). The locations of the maximum negative pressures are at corners (of the walls, roof hips, etc.). This makes these maximum negative pressures unusable, as those places are usually used for construction reinforcement.
- The overhangs have their highest negative pressure at the windward corners with *Joglo* having a slightly higher value than *Limasan*. Aynsley has mentioned this phenomenon.⁶ This will have a significant mechanical and structural implication, but in terms of indoor ventilation it might have no significance.
- Positive pressure only exists at windward sides (of the roofs and walls) at both sides of the centre lines (becoming negative towards the hips or corners). The corners of the walls, hips and ridges of the roofs have high negative pressures. This distribution of positive and negative pressure shows that most surfaces are affected by wind suction. Considering that Javanese roofs are porous, these wind suction effects generate a good ventilation effect where the indoor air can easily ventilate through small gaps between the clay tiles. During the field study, this phenomenon was obvious as smoke from the traditional stove rose and escaped through the gaps even on a relatively calm day.
- The maximum possible ΔC_p (based on average C_p) at roof level is different between *Joglo*

and *Limasan*. For *Joglo* it is between the windward and the side surfaces of the roof, whereas for *Limasan* it is between windward and leeward surfaces of the roof. This might cause different internal airflow patterns.

- There are small areas on the windward side with slightly higher C_p at points A and F. These areas with higher C_p do not occur in the hipped roof.
- Considering only the roof level, both *Joglo* and *Limasan* (with *sri* and *kitri*) have a higher possible maximum ΔC_p than the hipped roof. Thus, *Joglo* and *Limasan* have higher ventilation potential than the hipped roof.
- For the whole building, the possible maximum ΔC_p is found between the windward walls and the roofs. Since the original Javanese building design did not recognise windows, this potential for ventilation was not explored. However, it cannot be considered as a design flaw, as traditional Javanese building designs do prevent the occupants receiving excessive wind exposure. In new buildings, this potential might be useful.
- High negative pressures are found at sharp corners such as at hips, ridges, and wall corners. Though they provide more potential for ventilation, they might not be easily utilised, since usually they are obstructed by the building's construction. Redesign of these sharp corners might be introduced to maximise the potential of the ventilation.

9.8 Javanese Building Design and Aerodynamic Performance

The experiment found some facts about the aerodynamic performance of Javanese buildings which can be related to their *petungan* (*sri* and *kitri*) and styles (*Joglo* and *Limasan*). As has been mentioned, Javanese building designs are guided by specific orders (*petungan*/numerology, which gives a unique spiritual value to the building) and general traditional orders (styles, which give a unique form to the building). The results show very consistent changes between spiritual values (i.e. *sri* and *kitri*), between styles (i.e. *Joglo* and *Limasan*), and between building scales (small and large scale), which indicate that spiritual values, styles, and scales all affect the aerodynamic performance of Javanese buildings.

The finding that *kitri* allows more ventilation potential meets the recommendation of the *petungan*. Examples in Prijotomo's text⁷ (derived from the traditional references) clearly show that *Joglo* type applies *kitri* and *Limasan* applies *sri*. However, this recommendation is applied under a circumstance that it has to meet the *petungan* for the function of the building as well. It has been mentioned that *petungan* is more related to the function of the building rather than the style. (See Chapter Four for detailed explanation of Javanese architectural orders.) If a building is functioning as a *pendapa* (a semi-public space to welcome and entertain guests) than it should have *kitri*. On the other hand, if the building is utilised as a *dalem* (the main space for the family)

it should have *sri*. Meanwhile, there is no restriction in using a *Joglo* as a *dalem* and a *Limasan* as a *pendapa*. In that case, *Joglo* and *Limasan* should have *sri* and *kitri*, respectively.

Joglo and *Limasan* (and other styles) share common appearance, which generate the image of Javanese architecture. Two prominent characteristics of *Joglo* and *Limasan* are their combination of *guru* sectors and the two- or three-levelled roofs. The experiment found that these combinations affect the pressure coefficient distribution and the wake formation on the roofs. The two- and three-levelled roof type creates a non-linear pressure coefficient decrement at the windward side. Areas with slightly higher positive pressure are found near the fold line, which is not the case with the hipped roof.

In general, most surfaces are under negative pressures. The stronger positive pressures are found at areas around the centre line of the windward side of the roof and the wall. They become negative toward the corner of the wall, the hip of the roof and the ridge. Since Javanese roofs are porous, these negative pressures would suck the indoor air out; meanwhile the positive pressures would push the fresher outdoor air in. This process works continually if the wind is blowing.

With the ceilings at the *guru* sector, the biggest ΔC_p was found between two points: the top of windward wall to the intersection point between the hip of the *guru* sector and the hip of the *pananggap* sector. The good potential of the biggest ΔC_p may be ineffective in creating a good cross ventilation. The air movement will take a short path between those two points, even though it will also induce air circulation in the room.

9.9 The Performance of Computational Fluid Dynamic Program

During the experiment of the aerodynamics performance of Javanese building, some facts about the CFD program (i.e. CFD-ACE) were found. In general, the CFD-ACE has proved a user-friendly and versatile program even though moderate times are still needed to master it. However, once mastered, there should be no difficulty in using this general-purpose program to simulate building aerodynamics. There were some experiences worth noting:

- CFD-GEOM (Grid generator): The program is based on a structured grid method. This sometime makes simple geometry (such as a building with overhangs) seem complicated and can introduce bad cells. These bad cells encourage convergence problems.
- CFD-ACE (Flow solver): The flow solver is very sensitive to bad cells and sudden changes of cell volume. To remedy this problem, volume change between cells should be smoothed and under-relaxation should be turned high. Those result in, respectively, a huge number of

grid cells and slow convergence. To get the residual number reduced by five orders, approximately six hours of computing time is needed for each simulation. A batch file can be made to automatically order the computer to execute many simulations. For the ten models of Javanese buildings, for example, the computer could run three days non-stop. This, however, does not mean the process can be totally unattended. In many cases, the convergence problem cannot be predicted. Sometimes, only after three hours running, does the flow solver start showing convergence problems. This means that the computing should be aborted and re-executed after the cause of the problems can be found and fixed. If the problem is in the grid design, then the grid should be reviewed.

9.10 Summary

It was found that changes in *petungan* values, styles and scales affect the aerodynamic performance of Javanese buildings. *Joglo* style, *kitri* value and small-scale building create higher possible maximum ventilation potential at roof level than *Limasan*, *sri*, and large-scale building, respectively. The differences, however, are insignificant.

In general, at roof level, Javanese buildings have a higher possible maximum ventilation potential than non-Javanese buildings (represented by the hipped roof buildings). The use of porous roof materials (clay tiles) in small Javanese buildings (and gaps in large Javanese building) can be considered as a clever idea to utilise that ventilation potential. However, the possible maximum ventilation potential between wall and roof level is higher in non-Javanese buildings than that in Javanese buildings. This indicates that Javanese ventilation design is concentrated at the roof level.

Other findings:

- Javanese buildings and steep-hipped roofs (34°) create a long wind shadow on the leeward side. The less steeply hipped roofs (26°), on the other hand, produce only a short wind shadow.
- Maximum positive and negative pressures occur at locations with sudden geometry changes such as corners of walls, hips of roofs, and ridges. These locations have potential for ventilation but are difficult to utilise as they are usually at roof support structure locations.

The following chapter (Chapter Ten) will describe the thermal performance experiment.

Endnotes

¹ Prijotomo, J., 1995, Petungan: Sistem Ukuran dalam Arsitektur Jawa, Yogyakarta: Gadjah Mada University Press, pp.107-109.

² Ibid.

³ Aynsley, R.M., Melbourne, W. and Vickery, B.J., 1977, Architectural Aerodynamics, London: Applied Science Publisher, Ltd., p.89.

⁴ Prijotomo, J., loc.cit., pp.107-109.

⁵ Ibid.

⁶ Aynsley, R.M., op.cit., p.140.

⁷ Prijotomo, J., loc.cit., pp. 107-109.

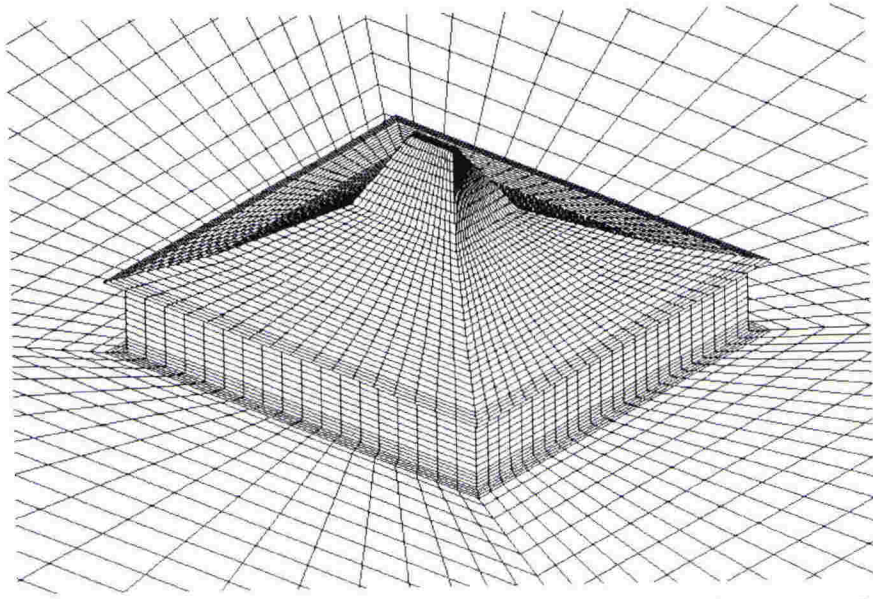

Figure 9-13 The grid design of a *Joglo kitri* model based on structured grid system (generated using CFD-GEOM).

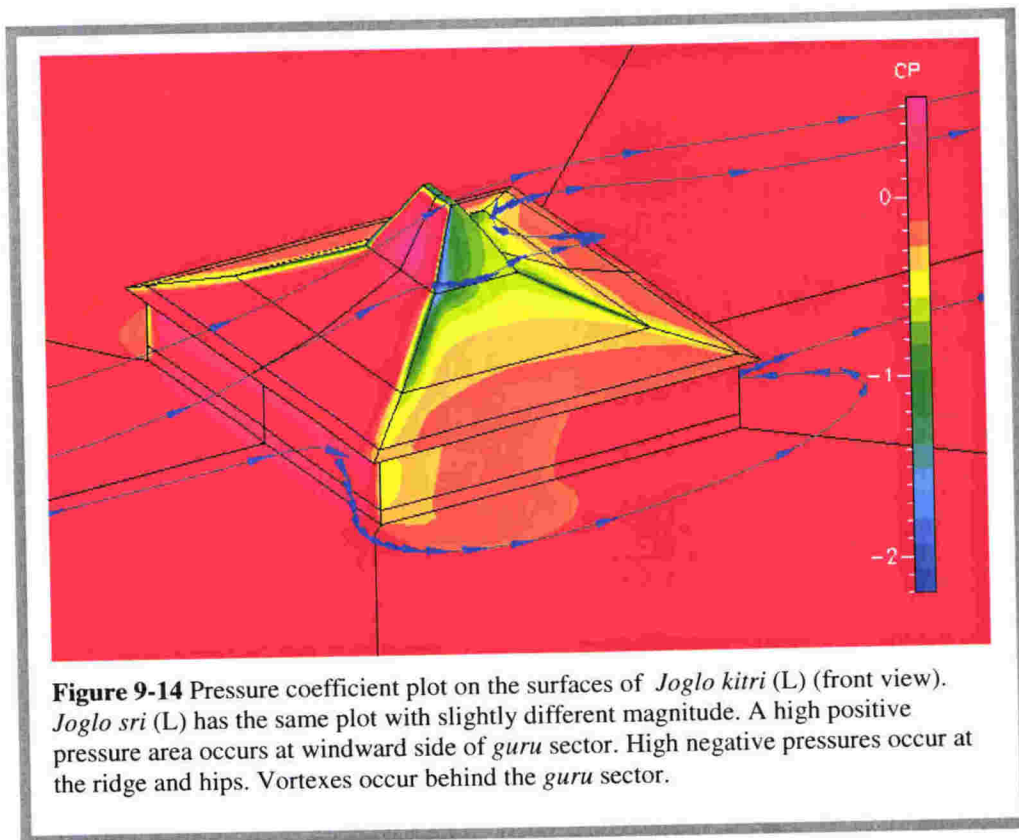

Figure 9-14 Pressure coefficient plot on the surfaces of *Joglo kitri* (L) (front view). *Joglo sri* (L) has the same plot with slightly different magnitude. A high positive pressure area occurs at windward side of *guru* sector. High negative pressures occur at the ridge and hips. Vortices occur behind the *guru* sector.

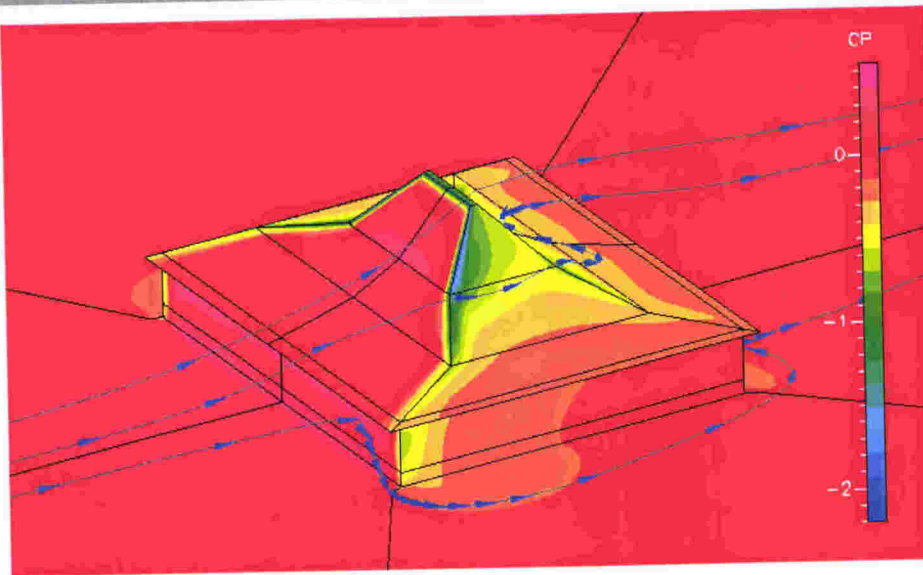

Figure 9-15 Pressure coefficient plot on the surfaces of *Limasan sri* (L) (front view). *Limasan kitri* (L) has the same plot with slightly different magnitude.

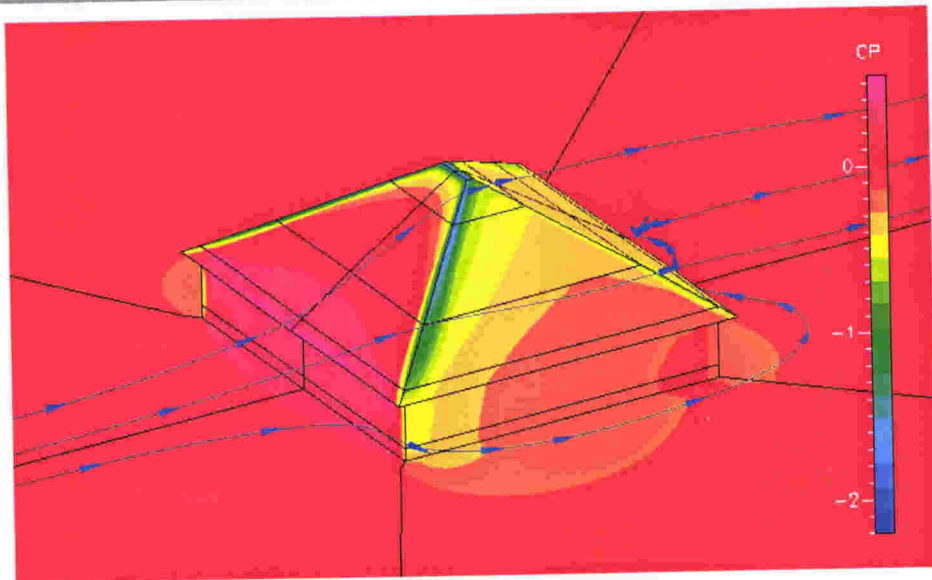
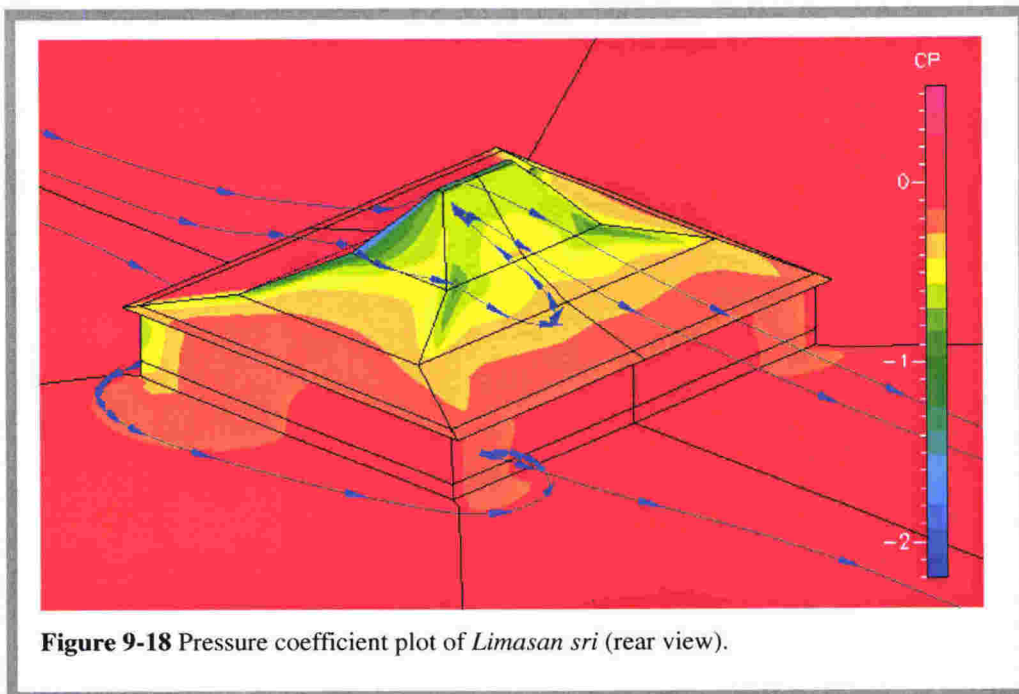
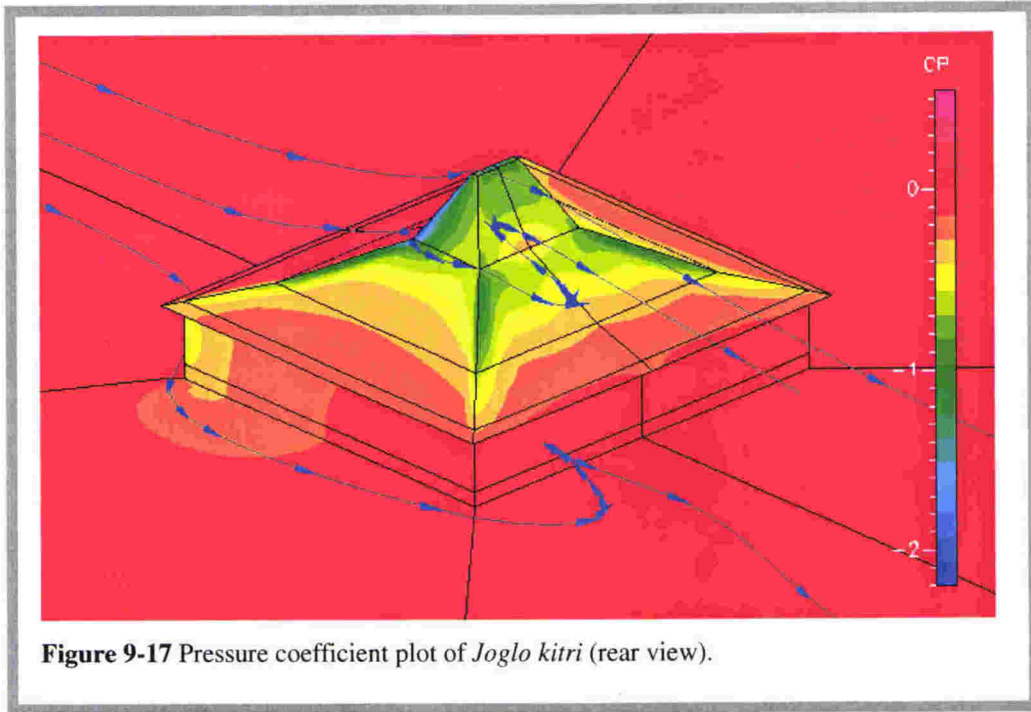

Figure 9-16 Pressure coefficient plot on the surfaces of hipped roof #2 (L) (front view). The high positive pressure area occurs at the windward overhang. Backward airflow occurs almost at the entire leeward surface of this 34° pitched roof. It is not the case in hipped roof buildings #1 which have their roof pitch 26° .



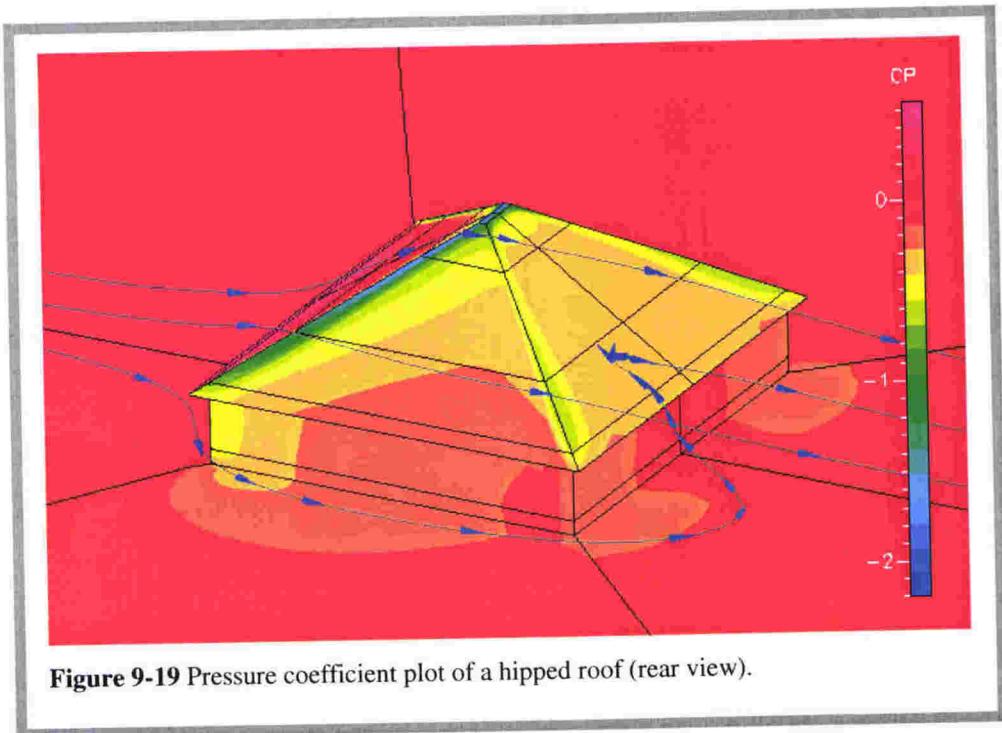

Figure 9-19 Pressure coefficient plot of a hipped roof (rear view).

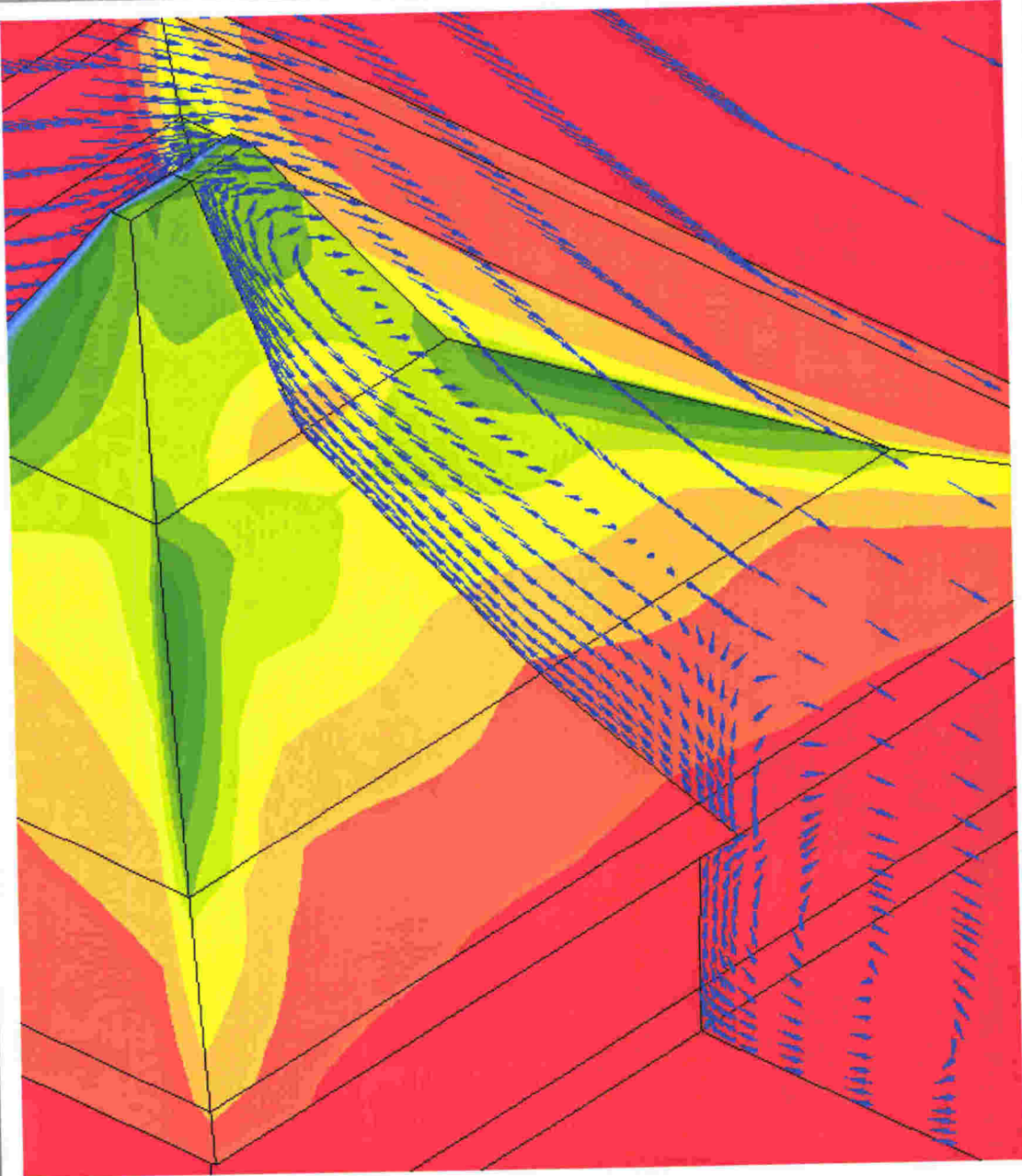

Figure 9-20 Vectors showing the backward airflow behind the *guru* sector of *Joglo kitri* (L).

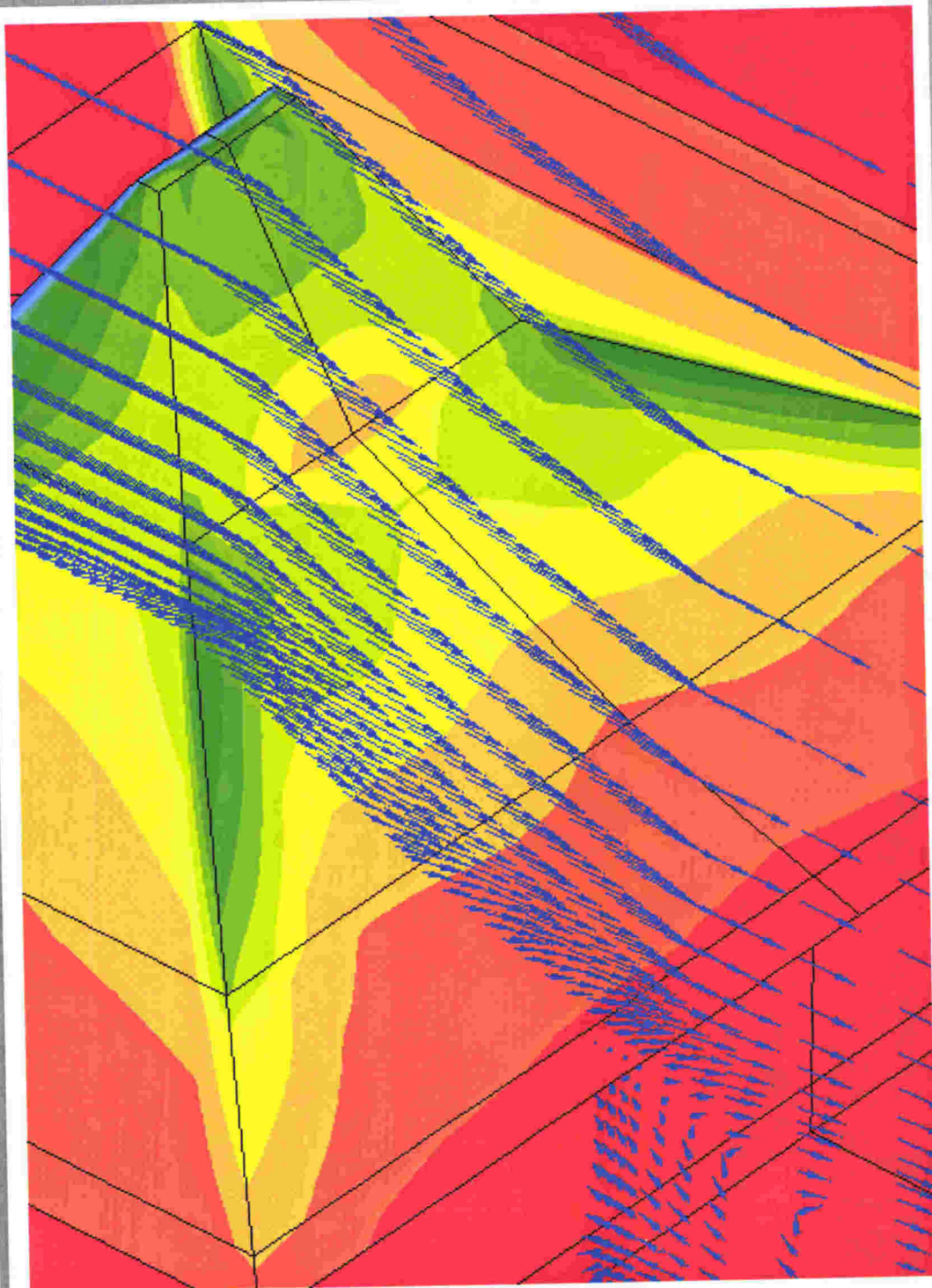

Figure 9-21 Vectors showing the change of airflow from backward flow (behind the *guru* sector) to forward flow (off the *guru* sector). Please compare with Figure 9-19.

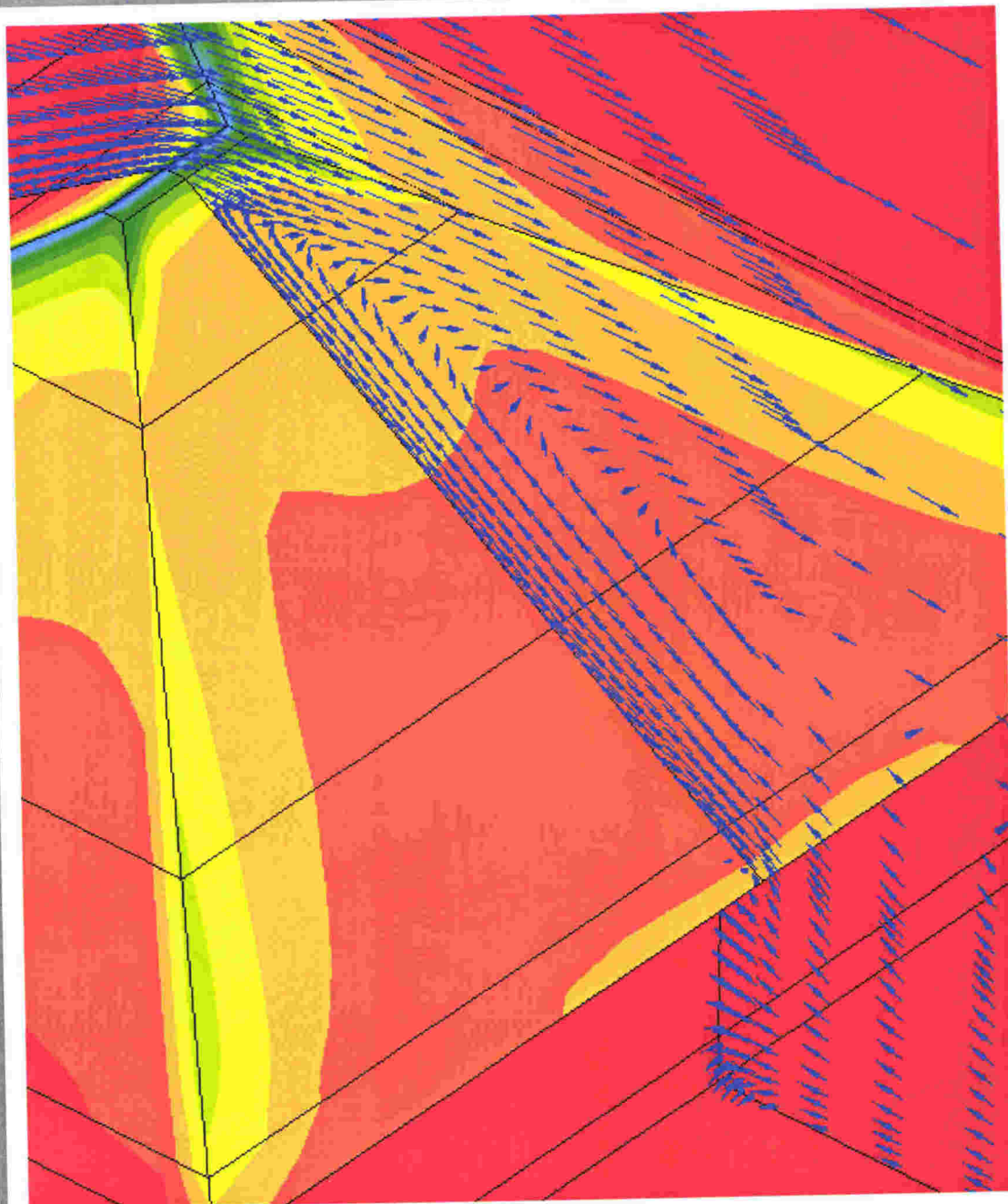

Figure 9-22 Vectors showing the backward airflow at the leeward side of a hipped roof #2 (L).

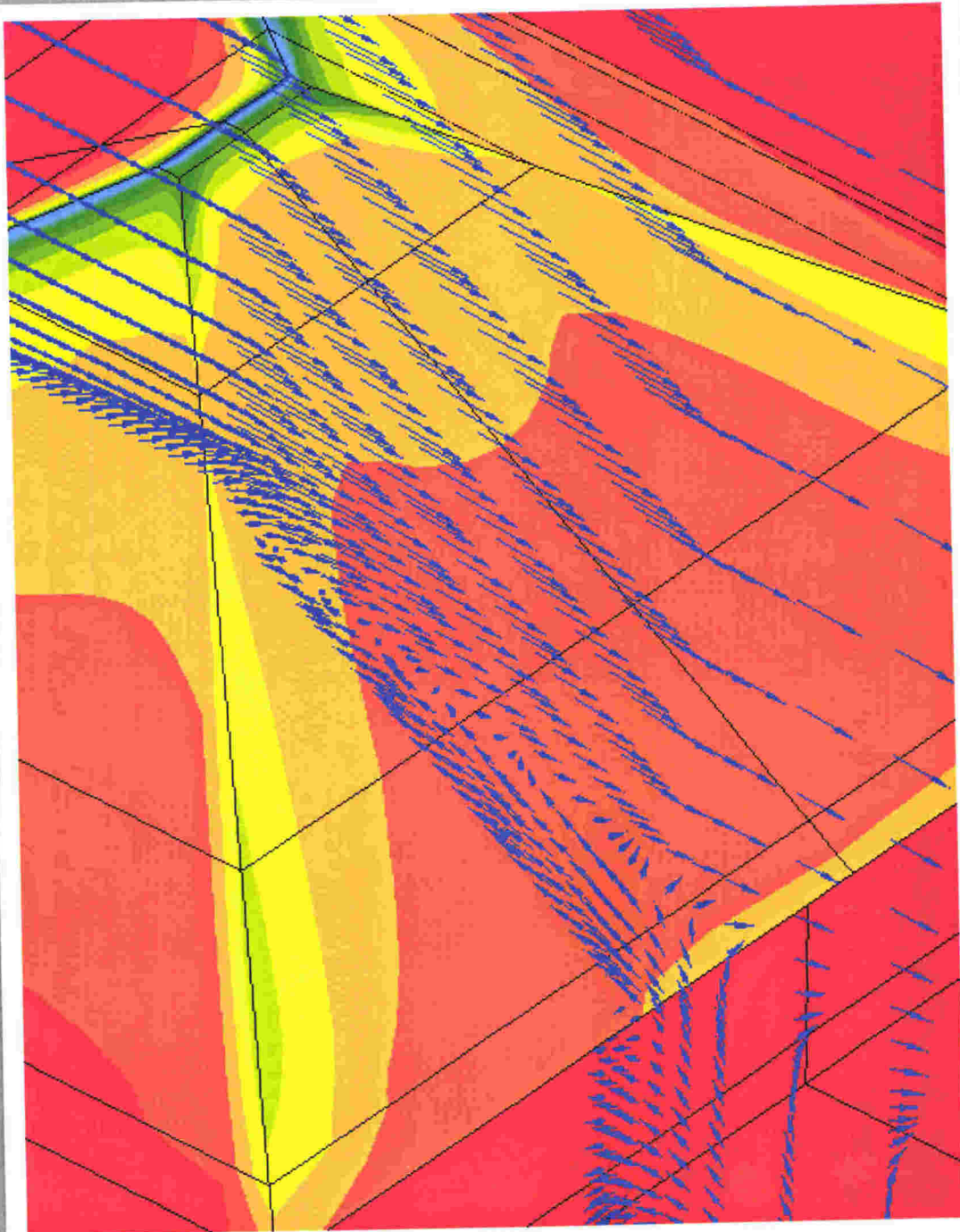

Figure 9-23 Vectors showing the backward airflow at the leeward side of a hipped roof#2 (L). This is not the case at the *Joglo* and *Limasan* where the backward airflow only occurs behind the *guru* sector.

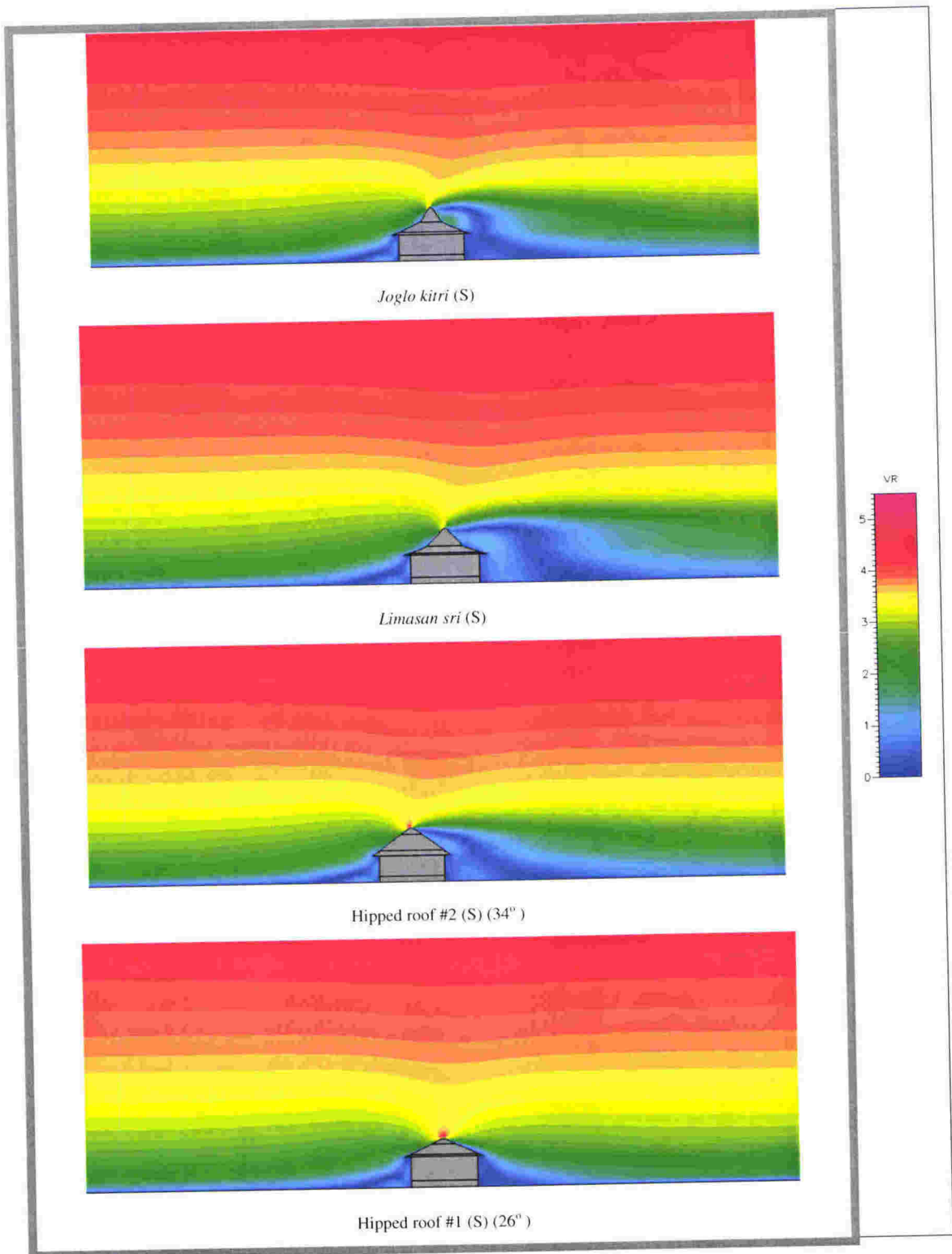

Figure 9-24 Comparison of air velocity distribution around small version models. The hipped roof#1(S) has the shortest wind shadow while *Limasan* has the longest. Small pitch of the hipped roof #1 building creates smooth airflow. In terms of ventilation, short wind shadow (area with very low air speed) will give a better air speed for close downwind buildings than long wind shadow. It is thus good for dense building areas such as in urban housings. For Javanese buildings, this issue is irrelevant as their design was intended for scattered buildings.

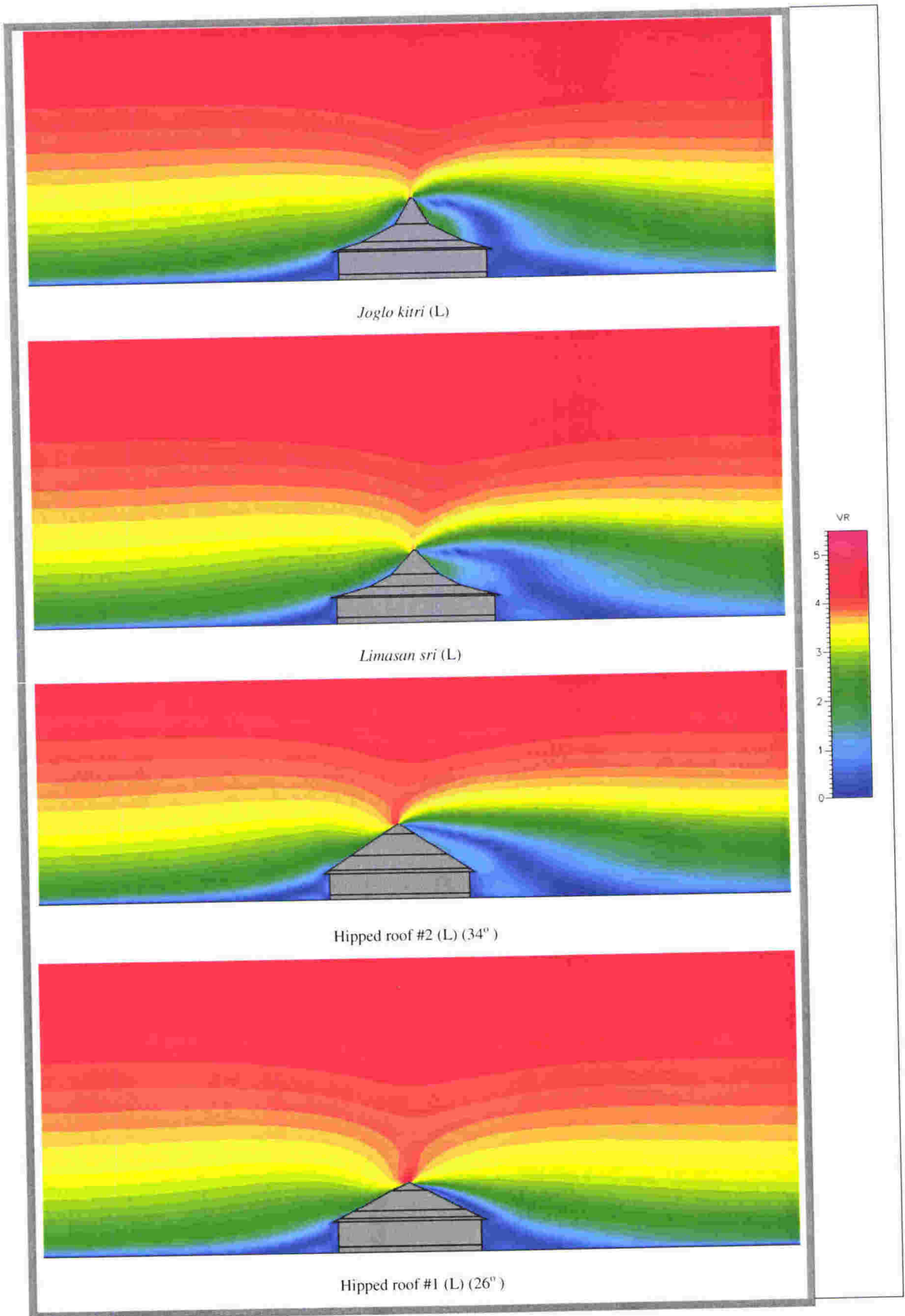

Figure 9-25 Comparison of air velocity distribution around large version models.

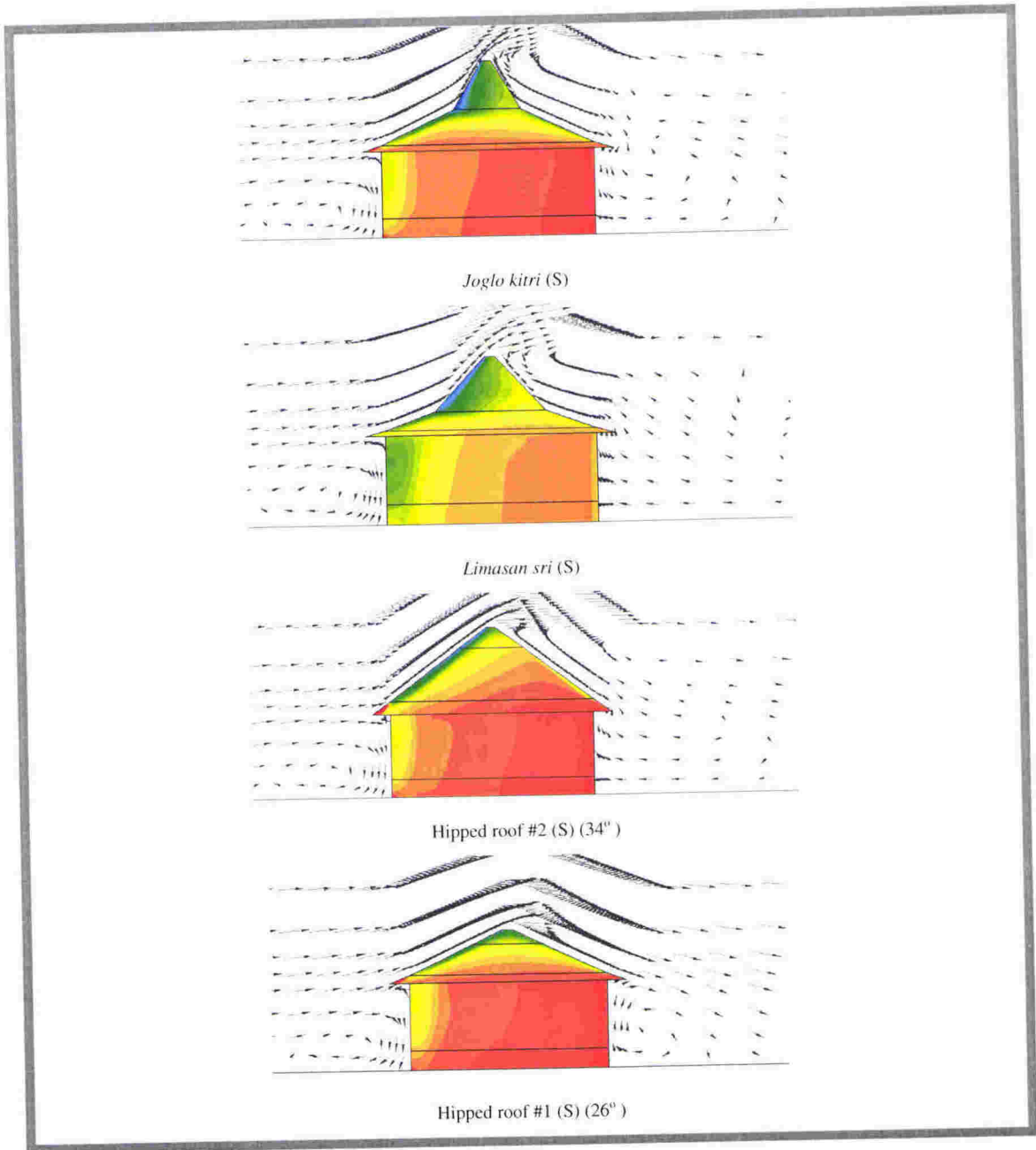

Figure 9-26 Vectors around small version models show almost the same airflow pattern. The hipped roof #1 shows the smallest vortex.

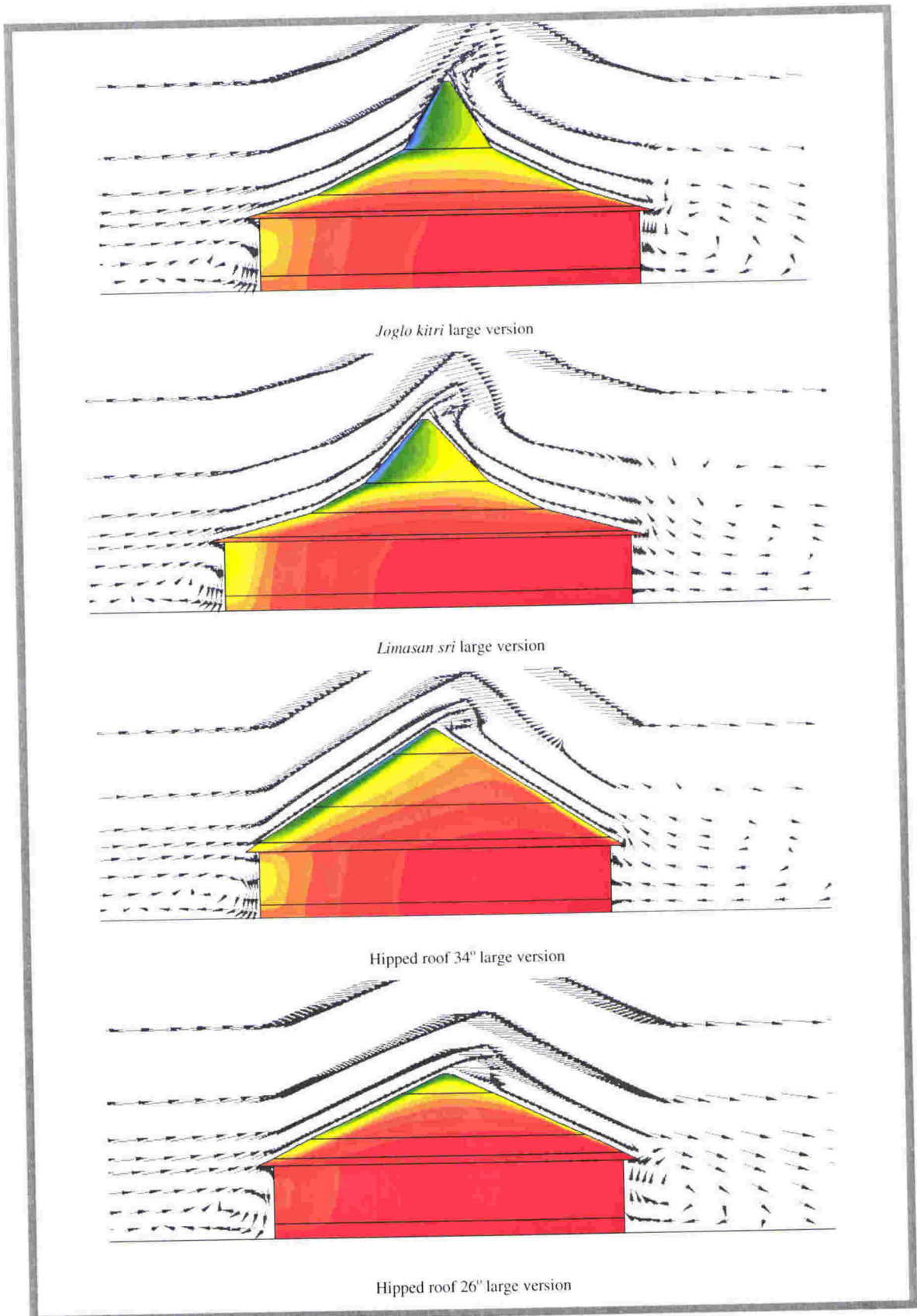

Figure 9-27 Vectors around large version models.

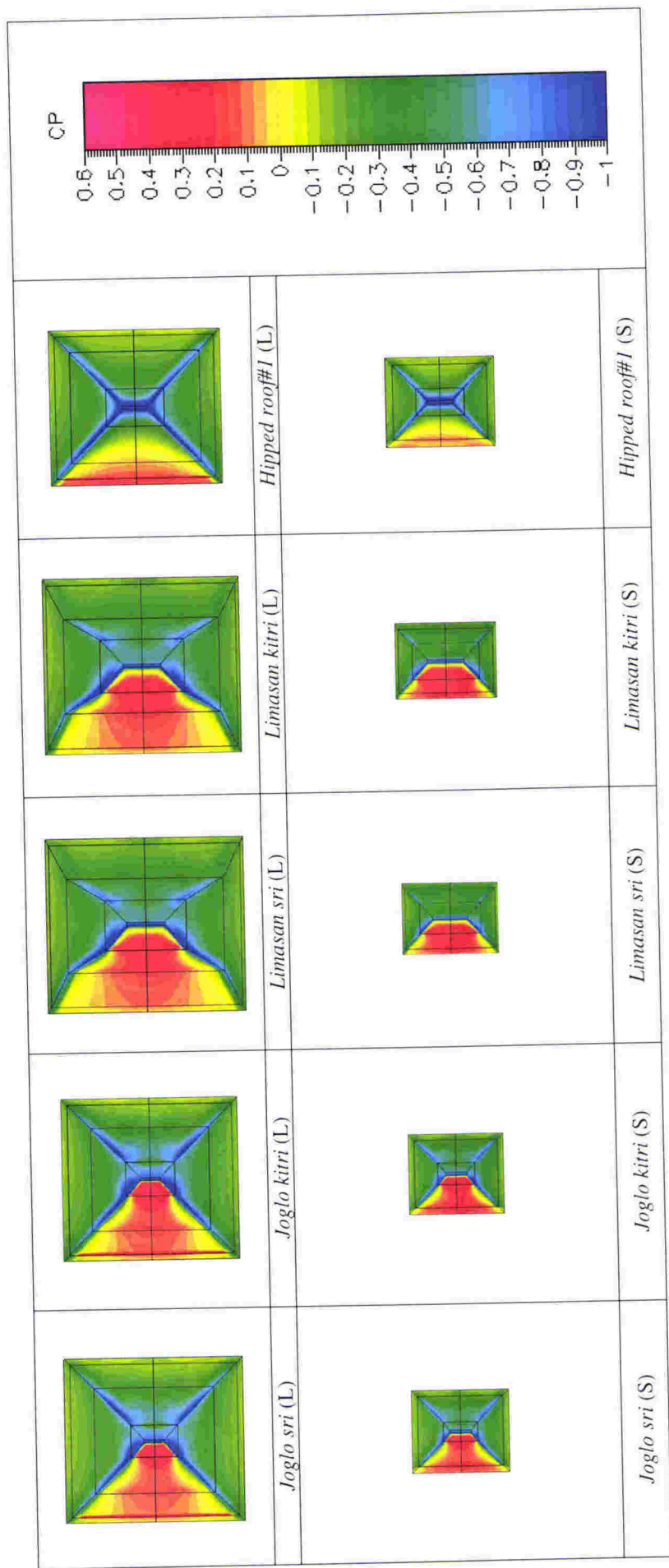
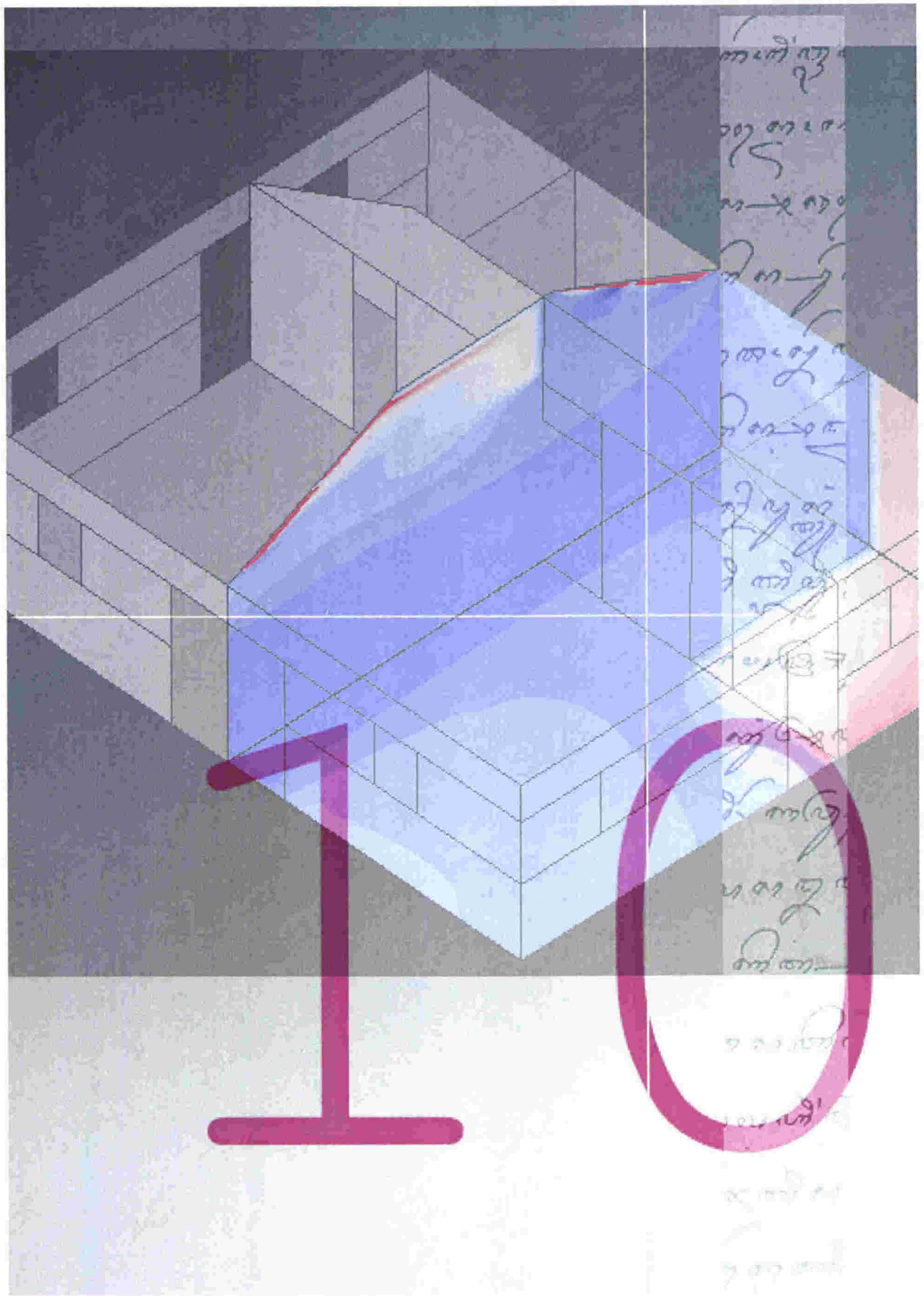

Figure 9-28 Comparison of pressure coefficient (C_p) plots on the roof surfaces.



10. JAVANESE BUILDINGS AND INDOOR THERMAL COMFORT PERFORMANCE

10.1 Introduction

This chapter discusses in detail experiments exploring the thermal comfort performance of Javanese buildings. It begins with descriptions of model selection, boundary conditions and flow domain, followed by a discussion of the experiments and their findings.

This exploration involved two main experiments. The first experiment studied the effect of solar radiation on the clay tiles' temperature and focused on a single clay tile. Using the results from the first, the second experiment studied the thermal performance of Javanese buildings, focusing on the internal parts of the buildings. Some minor experiments were also conducted to study the effect of partitions and airtight roof materials.

10.2 Model Selection

The effect of solar radiation on the clay tiles' temperature was calculated separately using the models listed in Table 10-1. The experiments studying thermal performance of Javanese buildings used only the internal parts of the buildings (see Table 10-2). These models were derived from models which were used in the aerodynamic performance experiment by omitting the exterior. Since the *guru* sector always has a ceiling, only the interior under this ceiling was modelled. It was assumed that the ceiling completely separates the cavity above it from the room below it.

Table 10-1 Models for experiments of the effect of solar radiation on clay tiles.

<i>Joglo</i>		<i>Limasan</i>	
<i>sri</i>	<i>kitri</i>	<i>sri</i>	<i>kitri</i>
Clay tiles	Clay tiles	Clay tiles	Clay tiles
<i>Guru, pananggap, panitih</i> sectors	<i>Guru, pananggap, panitih</i> sectors	<i>Guru, pananggap, panitih</i> sectors	<i>Guru, pananggap, panitih</i> sectors
Case-B1	Case-B2	Case-B3	Case-B4

Note: The pitches of the roof parts were maintained the same for *sri* and *kitri*. Since the effect of solar incidence angles is simply represented by different solar radiation intensity received by the clay tile surface, these six cases can in fact share the same model. Small version models do not have *panitih* sectors.

Table 10-2 Models for experiments of the thermal performance of Javanese buildings.

<i>Joglo</i>		<i>Limasan</i>		Hipped roof
<i>sri</i>	<i>kitri</i>	<i>sri</i>	<i>kitri</i>	
Internal	Internal	Internal	Internal	Internal
Case-C1S Case-C1L	Case-C2S Case-C2L	Case-C3S Case-C3L	Case-C4S Case-C4L	Case-C5#1S Case-C5#1L Case-C5#2S Case-C5#2L

Note: Case-C1S(mall version); Case-C1L(arge version)

Besides using the models as listed in Table 10-1 and Table 10-2, experiments were also conducted for some model variations as follows:

- A small version model of *Joglo sri* with internal partitions. This was to study the airflow and thermal comfort inside a partitioned Javanese building.
- A small version model of *Joglo sri* with gaps at the lower part of the walls. This was to study the effect of supplying outdoor air into a Javanese building without windows.
- Large version models of *Joglo kitri* and *Limasan sri* which use wood shingles as roofing material (with attached ceilings). This was to study the effect of different materials on indoor thermal comfort.
- A model of a clay tile hipped roof building typical of modern Indonesian houses. This was to study the effect of clay tiles on the thermal performance of buildings which do not apply Javanese style and numerology (*petungan*).

10.3 Geometry

The ideal thermal simulation should directly involve the sun. Thus, the effect of the solar radiation on the roofs' temperatures and their effect on the indoor air can be obtained simultaneously. CFD-ACE has the ability to simulate porous media, but not at the same location as other boundary conditions such as walls (which are required for defining hot bodies). To model the effect of porosity (which is, in fact, evenly distributed small gaps), some linear gaps were constructed in the roof. The roof's surfaces were defined as solid and had the material properties of clay tiles. Manual calculations could be done to calculate the roof temperatures and the results applied to the computer model. However, these would involve the heat balance calculation from conduction, convection, and radiation and would therefore require many trial and error calculations (iterations). As such an approach is very time consuming, it is therefore impractical and was not used in this experiment.

- **Clay tile model:**

The solar radiation experiment on clay tiles used a two-dimensional model. This model represented the longitudinal section of a clay tile. Only one model was required, as the effect of different angles of the roof (relative to the sun) can be represented by applying different solar radiation intensities. The thickness of the model is the thickness of the real clay tiles.









- **Interior modelling of Javanese buildings:**

As already discussed, the thermal performance experiment used the interior part of the models created for the aerodynamic performance experiment. Table 10-4 shows the exterior models and the corresponding interior models. The experiment utilised of the symmetry of Javanese buildings by only constructing on half of the model.

Table 10-3 Roof pitch, (° from horizontal).

		<i>Guru</i>		<i>Pananggap</i>		<i>Panitih</i>	
		<i>Paman- jang (ngajeng= Wingking)</i>	<i>Panyelak (kiwa= Tengen)</i>	<i>Pamanjang (ngajeng= wingking)</i>	<i>Panyelak (kiwa= Tengen)</i>	<i>Pamanjang (ngajeng= Wingking)</i>	<i>Panyelak (kiwa= tengen)</i>
<i>Joglo</i>	<i>sri</i>	56.5	61.2	26.6	26.6	17.3	17.3
	<i>kitri</i>	56.5	61.2	26.6	26.6	17.3	17.3
<i>Limasan</i>	<i>sri</i>	45.2	49.1	27.7	17	15.2	28.4
	<i>kitri</i>	45.2	49.1	27.7	17	15.2	28.4

Table 10-4 Interior and exterior models.

Style	Interior	Exterior
<i>Joglo sri (S)</i>		
<i>Joglo kitri (S)</i>		
<i>Limasan sri (S)</i>		
<i>Limasan kitri (S)</i>		

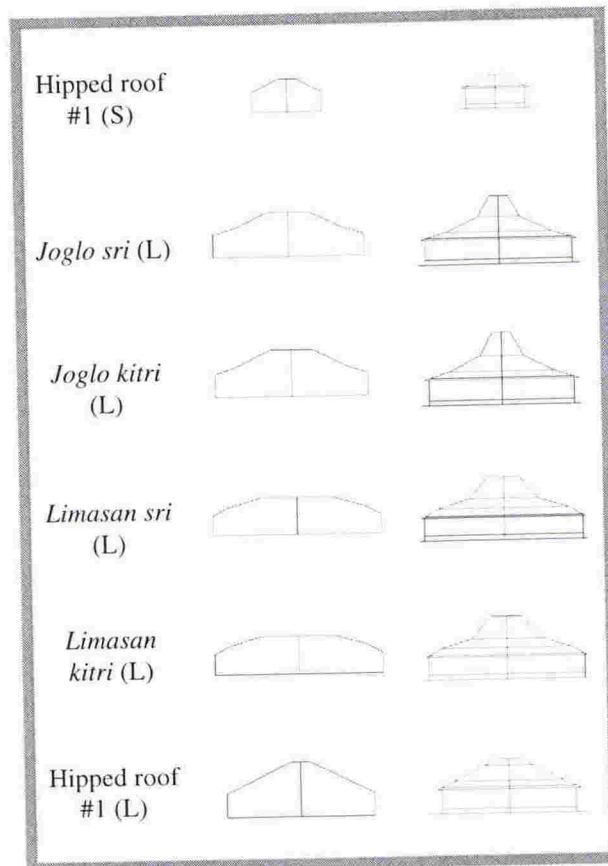

Note: The interior geometries were derived from exterior models by eliminating overhang, floors and space above the ceilings. Hipped roof models #2s are made by changing the roof pitch of hipped roof model #1 from 26° to 34°.

Table 10-5 Interior models of Javanese buildings.

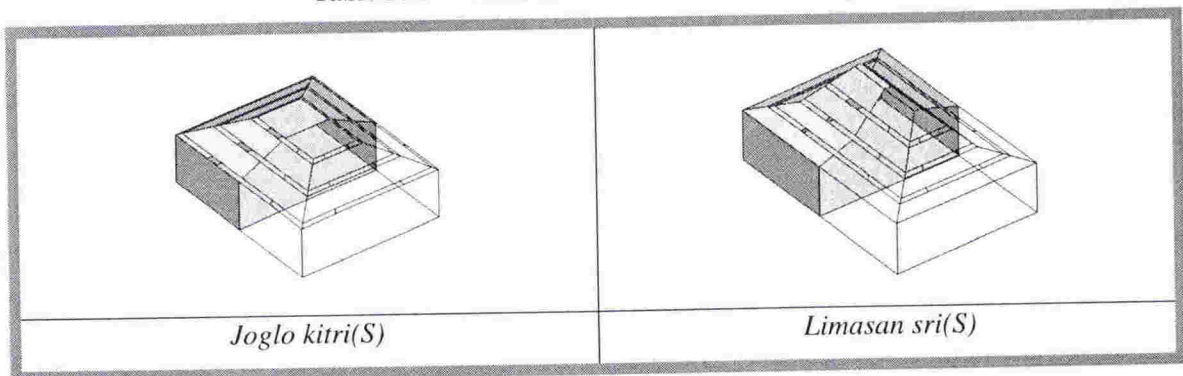

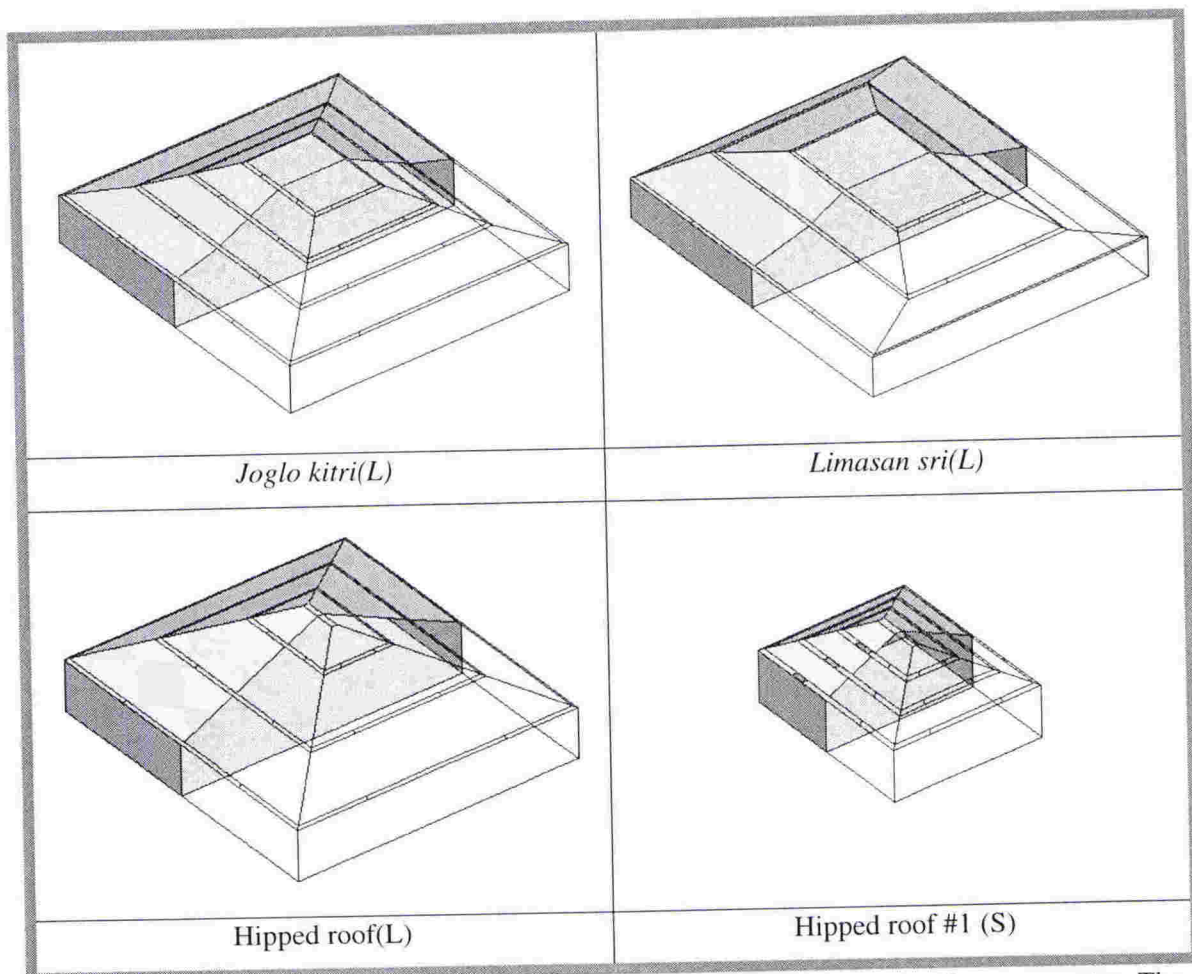

Note: *Joglo sri* and *Joglo kitri* are similar except that the former has a smaller *guru* sector. The above three-dimensional models were generated by CFD-GEOM and viewed using CFD-VIEW.

10.4 Boundary Condition

- **Clay tile model**

The clay tile model has its boundaries defined as CFD-ACE wall types. The upper side was defined to have a heat flux boundary condition, whereas the lower side was defined as a *wall* with convection and radiation heat transfer to the surroundings (i.e. indoor) air; sidewalls were defined as adiabatic. Calculations determining the magnitude of the heat flux were based on the solar radiation intensity and the roof pitch. The temperature of the clay tiles was measured at the lower side (facing to the room) of the model after thermal balance was achieved. This temperature was used to define the temperature of the roof of the interior model.

The large versions of Javanese roofs usually consist of twelve planes (four planes for each *guru*, *pananggap*, and *panitih* sector). To simplify the calculation, this experiment assumed the sun was at its zenith. As a result, only six surfaces needed to be calculated. Any two opposite surfaces have the same temperature increase, for example, *guru pamanjang ngajeng* = *guru pamanjang wingking*, *guru panyelak tengen* = *guru panyelak kiwa*. (front *guru* sector = rear

guru sector, left *guru* sector = right *guru* sector).

- **Interior models**

All the surfaces of the interior models were defined as CFD-ACE *walls*. The roofs have linear gaps to model the effect of porosity of the clay tiles. Some of the gaps were defined as inlet boundary conditions. Others were defined as outlet boundary conditions. The decision to apply inlet or outlet boundary conditions to the gaps was based on the results of the aerodynamics performance.

10.5 Flow Domain

Properties of materials need to be defined so that heat transfer and airflow can be modelled.

- **Clay tiles**

The clay tile model was defined as solid. There was no fluid flow in it and the material properties of clay were applied. Thus, to simulate the effect of solar radiation on the clay tiles, only heat transfer calculations were conducted.

- **Interior models**

The interior models were defined as an airflow domain. The flow domain inside the model was defined as occupied by turbulent airflow. The material properties of air at 300K (27°C) were applied. The turbulent kinetic energy (k) and turbulent energy dissipation rate (ϵ) were calculated using the same method as presented in Chapters Eight and Nine. In CFD-ACE, instead of manually calculating the value of ϵ , the width of the inlet can be inputted. The program will automatically calculate the value of ϵ .

10.6 Assessment Tool

The purpose of experiments was to study the environmental performance of Javanese architecture (i.e. aerodynamic and heat transfer) and its relation to comfort (i.e. thermal comfort). In other words, the effects of Javanese building environmental designs, specifically building aerodynamics and thermal characteristics, on the thermal comfort were to be observed. The most logical assessment criteria thus involve thermal comfort standards.

There are some thermal comfort standards available in references such as those developed by Houghton and Yaglou, Olgyay, and Fanger (See Table 6-7). There is also a user-friendly program, ASHRAE Thermal Comfort program, which can be used to evaluate thermal comfort. Standards are available in chart form (psychrometric and bio-climatic charts) or as formulae. For the CFD program the formulae form, Fanger's equation, is easier to use as it can be directly incorporated into the program post-processor module.

In this experiment, the thermal comfort formula developed by Fanger¹ is used. The formula is based on the six thermal comfort parameters: air temperature, velocity, humidity, mean radiant temperature, clothing, and metabolism. To avoid bias in assessing Javanese building thermal comfort performance, some scenarios of the environmental and occupants' habits within and around Javanese buildings were developed. Material from Chapter Three (the physical and non-physical conditions of Yogyakarta Special Region) and Chapter Six (Javanese residential building and their indoor thermal comfort performance) was used to construct the scenario.

The comfort criteria were supplied to the CFD-ACE post-processor module (CFD-VIEW). The CFD-VIEW can present the results graphically to show the thermally comfortable locations within the building. Fanger's Predicted Mean Vote (PMV) was used as the thermal comfort criteria. The PMV equations found in McIntyre's book² and Innova Air Tech Instruments web site³ were translated into a simple sub-routine and attached to the post-processor module. To calibrate the sub-routine, the comfort equations were translated into a simple FORTRAN program and compared to the ASHRAE Thermal Comfort program. To assess potential discomfort the PPD (Predicted Percentage of Dissatisfied) was also calculated.

Fanger's comfort equations are as follows:

$$PMV = (0.303 \cdot e^{-0.036M} + 0.028)[(M-W) - H - E_c - C_{res} - E_{res}]$$

$$H = \varepsilon\sigma(A_r/A_{Du})f_{cl} [(t_{cl}+273)^4 - (t_r+273)^4] + f_{cl}h_c(t_{cl}-t_a)$$

$$T_{cl} = t_{sk} - I_{cl}k_1f_{cl} [(t_{cl}+273)^4 - (t_r+273)^4] - I_{cl}f_{cl}h_c(t_{cl}-t_a)$$

$$k_1 = \varepsilon\sigma(A_r/A_{Du}) = 39.6 \cdot 10^{-9}$$

$$h_c = 2.38 \cdot (t_{cl}-t_a)^{0.25} \text{ or } 12.1 \cdot (V_{ar})^{0.5} \text{ which ever is bigger}$$

$$f_{cl} = 1.00 + 1.29 \cdot I_{cl} \text{ for } I_{cl} < 0.078 \text{ m}^2\text{C/W or}$$

$$1.05 + 0.645 \cdot I_{cl} \text{ for } I_{cl} \geq 0.078 \text{ m}^2\text{C/W}$$

$$t_{sk} = 35.7 - 0.028 \cdot (M-W)$$

$$E_c = 3.05 \cdot 10^{-3} \cdot [5733 - 6.99 \cdot (M-W) - p_a] + 0.42 \cdot (M-W - 58.15)$$

$$C_{res} = 0.0014 \cdot M \cdot (34 - t_a)$$

$$E_{res} = 1.72 \cdot 10^{-5} \cdot M \cdot (5867 - p_a)$$

$$PPD = 100 - 95 \cdot e^{-(0.03353 \cdot PMV^4 + 0.2179 \cdot PMV^2)}$$

Where ,

M	= Metabolic rate, W/m^2
W	= Effective mechanical power, W/m^2
p_a	= Humidity, Partial water vapour pressure, Pa
t_a	= Air temperature, $^{\circ}C$
t_r	= Mean Radiant Temperature, $^{\circ}C$
f_{cl}	= Clothing are factor. The ratio of the surface area of the clothed body to the surface area of the naked body
V_{ar}	= Relative mean air velocity. The air velocity relative to the occupant, including body movement, m/s
t_{cl}	= Clothing surface temperature, $^{\circ}C$
I_{cl}	= Clothing insulation, m^2C/W
E_C	= Evaporative heat exchange at the skin, when the person experiences a sensation of neutrality, W/m^2
C_{res}	= Respiratory convective heat exchange, W/m^2
E_{res}	= Respiratory evaporative heat exchange, W/m^2
T_{sk}	= Skin temperature, $^{\circ}C$
H	= Dry heat loss. Heat loss from the body surface through convection, radiation and conduction
PMV	= Predicted Mean Vote
PPD	= Predicted Percentage of Dissatisfied

PMV and PPD can be used to measure the degree of comfort at the occupants' zone. Typical heights normally chosen are at 0.15m (ankle), 0.6m (back level, seated), 1.2 (head level, seated), and 1.8m (head level, standing). In this experiment, the occupants' zone was considered to be that shown at Figure 6-3. It covers the area from the floor to about the head level of a standing man. For simplicity, the measurement is done at 1.2 m which is the average head height of seated people. This simplification should not give significant impact, since some measurements found that vertical temperature gradient at the occupants' zone (0 – 1.8 m from the floor) is very small, in the order of $0.1^{\circ}C$.

10.7 Experiment on the Effect of Solar Radiation on the Clay Tiles' Temperatures

This experiment substitutes the need to conduct a manual calculation to find the temperature increase of roof surfaces under the sun. The geometry has been discussed previously.

Roof materials are different between small and large buildings. The small versions of *Joglo* and *Limasan*, which are usually used by common people, use clay tiles and only have a ceiling on the *guru* sector. The large versions, which are commonly used by royal families, often use wood shingles and have ceilings over all sectors. These ceilings are often directly attached to the roof. As a result, the large buildings have their internal roofs' surfaces lower than the small buildings do. Also, these large buildings may not have ventilation through a porous roof. However, they usually have linear gaps between sectors, which might produce the same effect as the porous roof. Thus, large versions will only be used as if they have the same materials as the small version.

The effect of different solar radiation incidence angles can be simply simulated by specifying different radiation intensities, calculated using the following simple formula:

$$I_{ct} = I \cdot \cos\alpha$$

Where I_{ct} = solar radiation at the clay tile upper surface, W/m^2

I = solar radiation intensity perpendicular to the horizontal plane, W/m^2

α = the pitch of the roof, ° (see Table 10-3, for the roof angles)

Data to be used in the calculation:

- Roof material: clay tiles (density, $\rho = 2645 \text{ kg/m}^3$; heat capacity, $c = 960 \text{ J/kg}^\circ\text{C} = 0.267 \text{ Wh/kg}^\circ\text{C}$; thickness, $\delta = 6 \text{ mm}$; emissivity, $e = 0.6$; conductivity, $k = 0.775 \text{ W/mK}$)⁴, δ is the average thickness of clay tiles.
- Roof pitch (θ), see Table 10-3
- Air temperature: 27°C (300K)
- Convection heat transfer coefficient, $h_c = 16 \text{ W/m}^2^\circ\text{C}$ (This figure was assumed, as there is no measured data available for Indonesian buildings. The rate of heat transfer by convection is usually a complicated function of surface geometry and temperature, fluid temperature and velocity, and fluid thermo-physical properties⁵, which is beyond the scope of this experiment to discuss in detail.) Koenigsberger⁶ offers 9.48 for underside of the roof. For external surfaces, he offers a range from 14.20 (for sheltered roof) to 56.70 (severe exposure roof). Mills⁷ gives h_c range from 3 to 25 for air free convection.
- Solar radiation intensity, $I = 540 \text{ W/m}^2$

The simulated roof temperatures presented in Table 10-6 show a temperature range from 312 to 323K (39 to 50°C). The temperature range closely resembles field data (32 to 51°C), which was measured using the Wallac thermometer. To repeat, in order to reduce the complexity of models, this experiment defined the roof surfaces as flat. Thus, some unique features of Javanese roofs (such as the overlapping arrangement of tiles with air gaps; mould layers on the tiles' surface) could not be easily modelled. As a result, Table 10-6 might give slightly higher temperatures (2 to 3°C) than may be the case if those unique features were considered.

Table 10-6 Roof temperatures from experiment, $I = 540 \text{ W/m}^2$.

		Guru		Pananggap		Panitih	
		Paman- jang (ngajeng= wingking), K (°C)	Panyelak (kiwa= tengen), K (°C)	Pamanjang (ngajeng= wingking), K (°C)	Panyelak (kiwa= tengen), K (°C)	Pamanjang (ngajeng= wingking), K (°C)	Panyelak (kiwa= tengen), K (°C)
Joglo	sri (Case- A1)	314 (41)	312 (39)	321 (48)	321 (48)	322 (49)	322 (49)
	kitri (Case- A2)	314 (41)	312 (39)	321 (48)	321 (48)	322 (49)	322 (49)
Limasan	sri (Case- A4)	317 (44)	316 (43)	321 (48)	322 (49)	323 (50)	321 (48)
	kitri (Case- A3)	317 (44)	316 (43)	321 (48)	322 (49)	323 (50)	321 (48)

Note: Solar radiation intensity of 540 W/m^2 was taken as an average (see 3.4); The roof pitches are listed in Table 10-3. Each calculation could be solved within three seconds with residual number of ten orders lower than the initial values.

10.8 Experiment on the Thermal Performance of Javanese Buildings

Data input for this experiment:

- The scenario can be seen in Table 10-7. It reconstructs a normal day situation both inside (i.e. the occupants) and outside (i.e. the environment) a Javanese building by combining certain parameters (presented by shaded cells). The selected values (shown by the shaded cells) are the average values for normal days.
- Air properties for air temperature at 27°C : conductivity (k)= 0.0267 W/mK ; density (ρ)= 1.177 kg/m^3
- Gravity: 9.8 m/s^2

Data input for this experiment is basically the same as that used in the aerodynamic performance experiment. The results of the clay tile temperature experiment were applied to the roof surfaces. This scenario, which was used in the experiment of aerodynamic performance, used also in experiments of thermal performance. The emissivity of surfaces is set to 0.9 (Koenigsberger⁸ ranges the emissivity of red brick, stone and tile from 0.85 to 0.95). This experiment did not account for the possibility of any internal heat sources.

Table 10-7 Scenario

Atmospheric/climatic			Topography/geography			Human		
The sun radiation intensity, W/m ²	Minimum, cloudy	360	Ground roughness height, RH,	Stands alone surrounded by paddy field, terrain category 2	0.03	Clothing values, clo	Minimal; Bare chest, shorts, bare feet	0.1
	Average, scattered clouds	540		Surrounded by woods, terrain category 3	0.3		Average; typical tropical clothing ensemble	0.3
	Maximum, clear sky	1000		In the city, surrounded by multi-level buildings, terrain category 4	3		Maximum; light summer clothing	0.4
Air temperature, °C	Minimum	20	Atmospheric boundary layer, thickness, m	Stands alone surrounded by paddy field, terrain category 2	300	Metabolic rate, met	Minimum; sleeping soundly	0.8
	Average	27		Surrounded by woods, terrain category 3	400		Average; relax, reading, chatting	1.0
	Maximum	34		In the city, surrounded by multi-level buildings, terrain category 4	500		Maximum; sedentary work,	1.2
Air velocity, m/s	Minimum, calm	0						
	Average, normal	3.53						
	Maximum, windy	5.56						
Air humidity, %	Minimum, noon, bright sun	70						
	Average	80						
	Maximum, morning or after raining	90						
Wind direction, degree from the north	Minor, the third most frequent direction	180						
	Average, the second most frequent direction	210						
	Major, the most frequent direction	240						
Sky conditions, estimated duration of constant solar radiation, hour	Heavy overcast cloud	0						
	Normal, intermittent cloud	1						
	Clear sky	2						

As already mentioned, CFD-ACE cannot simulate heat transfer through porous media. Thus, to model that phenomenon, some linear gaps were constructed on the roofs and defined as inlets and outlets. It was expected that these linear gaps would not be able to perfectly substitute the Javanese roof porosity, which creates evenly distributed ventilation. However, airflow through these linear gaps is important in simulation of driving forces for air movements as well as fresh air supply to the building. There are two options to induce these driving forces: applying either a fixed velocity or total pressure at the inlets.

- First option: applying fixed velocities at the inlets. This option is impractical, as data on the air velocity at the inlets is not readily available. Even though the air velocity can be manually calculated from experimental results of aerodynamic performance, it is time and labour consuming.
- Second option: to apply total pressures to the inlets. In this option, total pressures obtained from experiments of aerodynamic performance can be used directly. This option has four sub-options: no velocity direction, normal, Cartesian, and cylindrical direction. Of these, the third option is ideal, as the air direction can be controlled.

Table 10-8 Comparison of the small versions.

	<i>Joglo sri</i> (Case-C1S)	<i>Joglo kitri</i> (Case-C2S)	<i>Limasan sri</i> (Case-C3S)	<i>Limasan kitri</i> (Case-C4S)	Comments
Airflows pattern	External air enters through inlets, pushed upward by stack effect, clung to the underside of the ceilings, partly escaped through the outlets and partly flows downward to the occupant' zone with a chaotic movement.	External air enters through inlets, pushed upward by stack effect, crawling underneath the ceilings, partly escaped through the outlets and partly flows downward to the occupant' zone with a chaotic movement.	External air enters through inlets, pushed upward by stack effect and fill in the <i>guru</i> sector, partly escaped through the outlets and partly flows downward to the occupant' zone with a chaotic movement.	External air enters through inlets, pushed upward by stack effect and fill in the <i>guru</i> sector, partly escaped through the outlets and partly flows downward to the occupant' zone with a chaotic movement.	Warm roof heats air underneath and creates stack effect. The ceiling in <i>Joglo</i> blocks the upward air movement. Oppositely, since there is no ceilings in <i>Limasan</i> the air can flow further and fill the space at <i>guru</i> sector. It also receives heat from <i>guru</i> sector surfaces.

Air velocity	0.294 m/s; small fluctuated speed, imperceptible.	0.304 m/s; small fluctuated speed, imperceptible.	0.303 m/s; small fluctuated speed, imperceptible.	0.342 m/s; small fluctuated speed, imperceptible.	<i>Limasan</i> and <i>kitri</i> create higher air velocity than, respectively, <i>Joglo</i> and <i>sri</i> . The difference is insignificant and the air velocity is imperceptible.
Air temperature	~27.989°C; small air temperature range, southern part of the room is cooler than northern part.	~27.984°C; small air temperature range, southern part of the room is cooler than northern part.	~28.987°C; small air temperature range, southern part of the room is cooler than northern part.	~28.966°C; small air temperature range, southern part of the room is cooler than northern part.	<i>Joglo</i> and <i>kitri</i> create lower air temperature than, respectively, <i>Limasan</i> and <i>sri</i> . Air temperature inside <i>Joglo</i> is 1°C lower than that inside <i>Limasan</i> . The southern part of the room is cooler than the northern part.
PMV	0.071; comfortable, tend to slightly warm.	0.049; comfortable, tend to slightly warm.	0.549; comfortable, slightly warm.	0.478; comfortable, slightly warm.	<i>Joglo</i> and <i>kitri</i> create more thermally comfortable indoor air than, respectively, <i>Limasan</i> and <i>sri</i> with the tendency to warm.
PPD	5.103	5.049	11.306	9.773	<i>Joglo</i> and <i>kitri</i> create more thermally comfortable indoor air than, respectively, <i>Limasan</i> and <i>sri</i> with a less percentage of people dissatisfied.

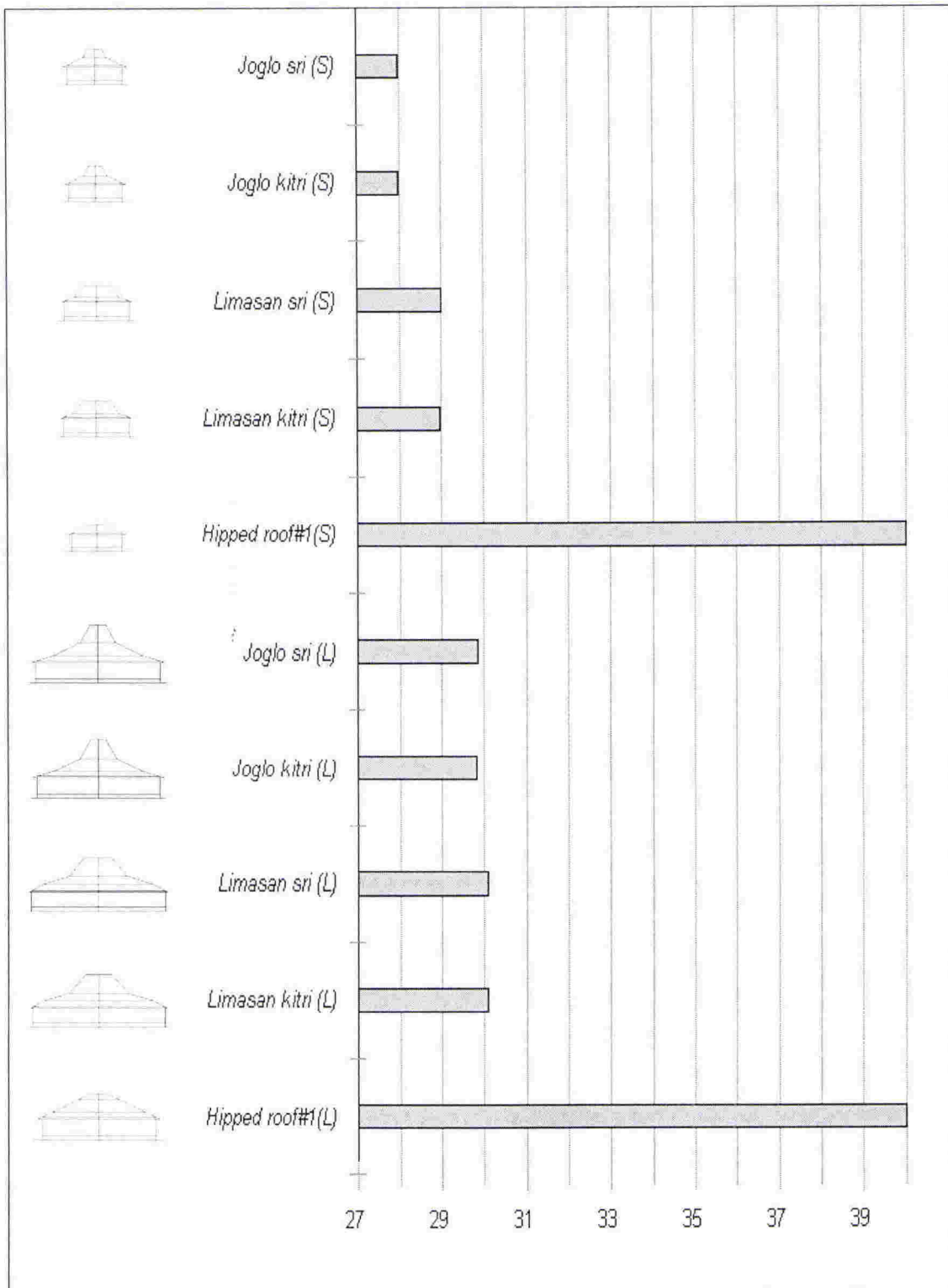

Figure 10-1 Comparison of indoor air temperature (°C). *Joglo*, *kitri* and small scale buildings create lower indoor temperatures than, respectively, *Limasan*, *sri* and large scale buildings do. Indoor air temperature of *Joglo* is 1°C lower than that of *Limasan*. Javanese buildings have lower indoor temperatures than non-Javanese buildings (hipped roof buildings) do with a very significant difference.

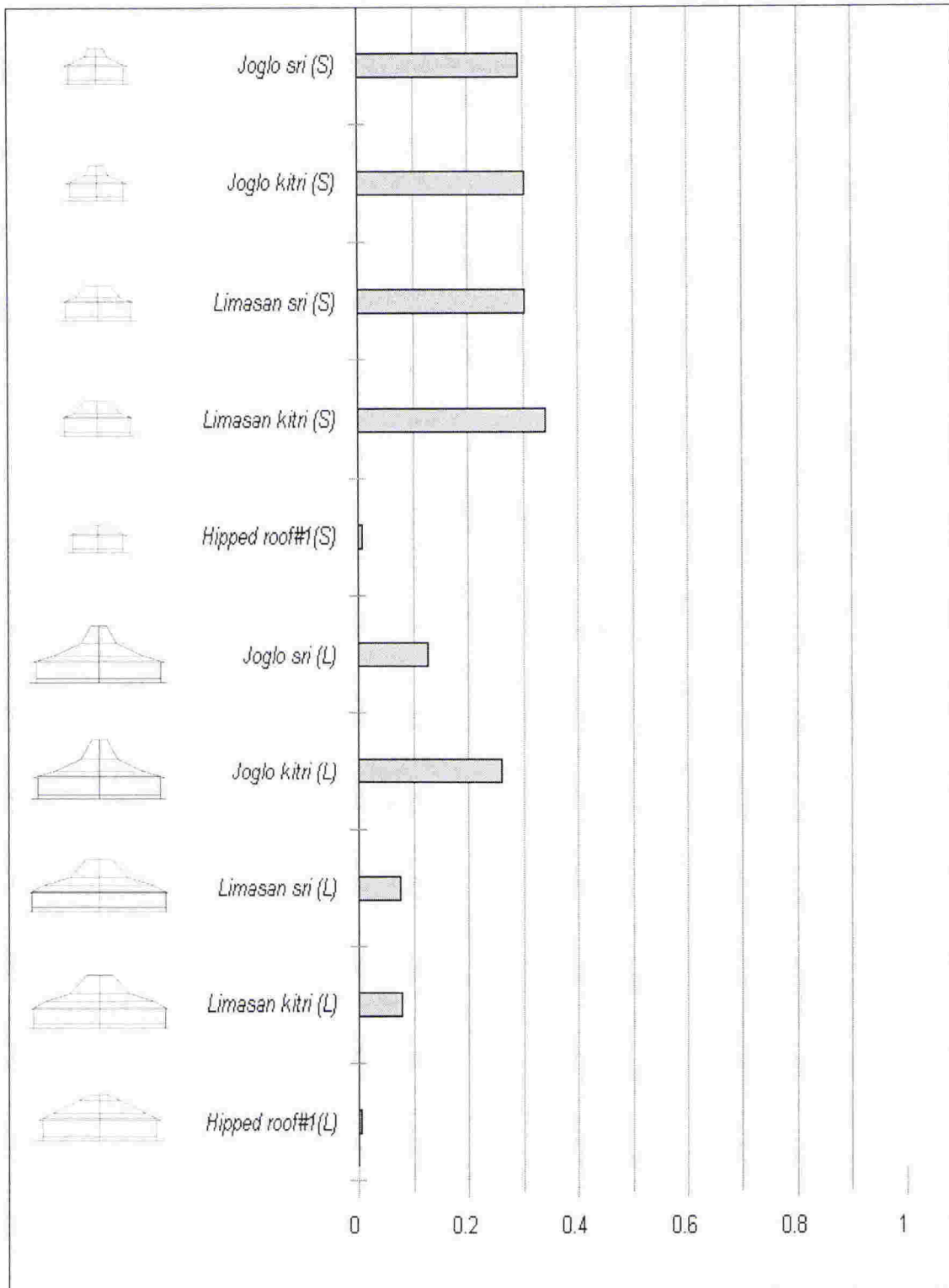

Figure 10-2 Comparison of indoor air velocity (m/s). There is no obvious effect of styles and *petungan* to the indoor air velocities. Small-scale Javanese buildings have higher air velocities than their large-scale counterparts. Javanese buildings have very much higher indoor air velocity than non-Javanese (hipped roof) buildings do.

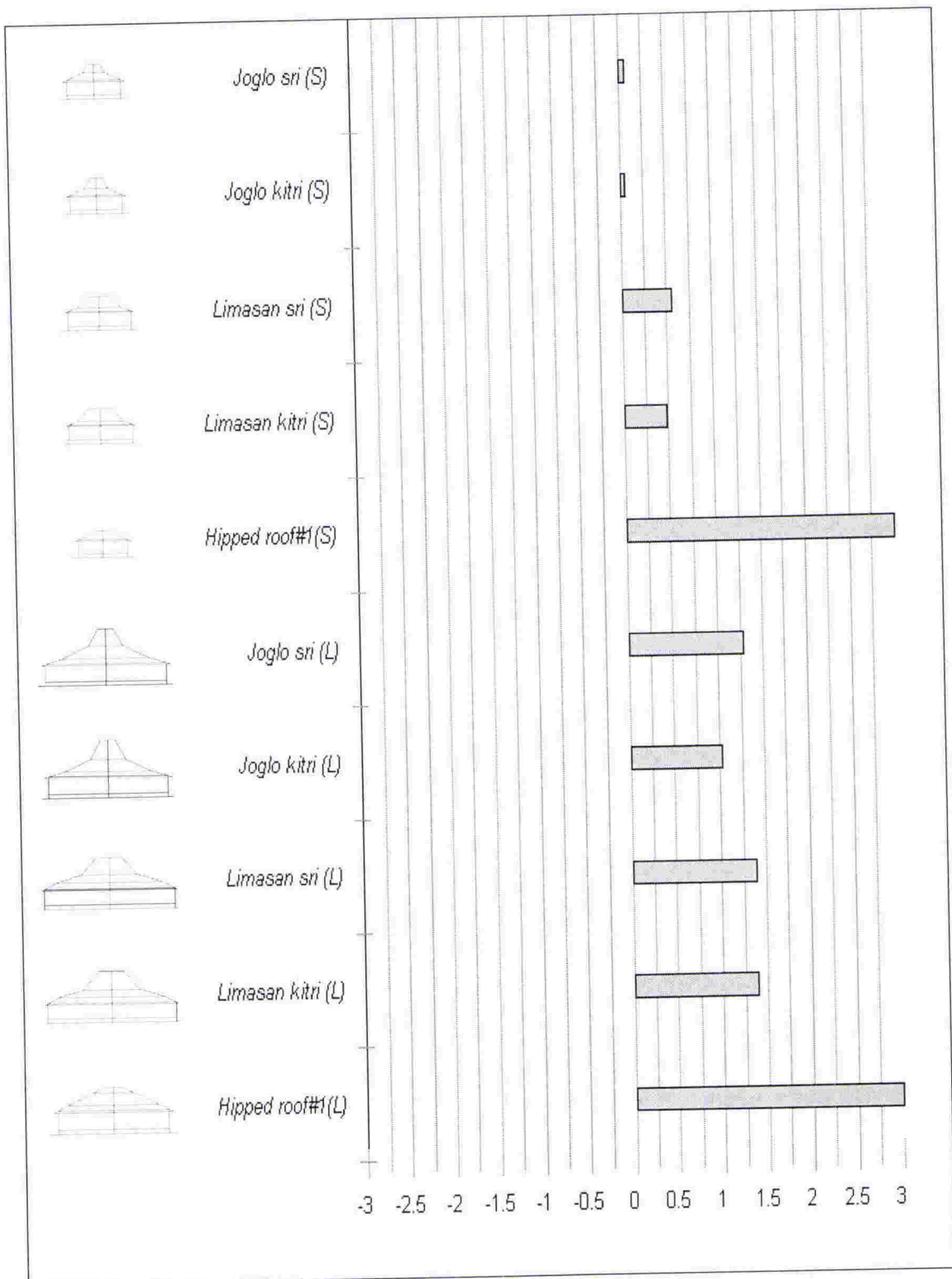

Figure 10-3 Comparison of Predicted Mean Values (PMV). Javanese buildings are thermally comfortable. *Joglo*, *kitri* and small scale buildings create more thermally comfortable indoor air than, respectively, *Limasan*, *sri* and large scale buildings do. Styles has a bigger effect on thermal comfort than *petungan* does. *Petungan* gives insignificant effects. Non-Javanese (corrugated steel-hipped roof) are thermally uncomfortable.

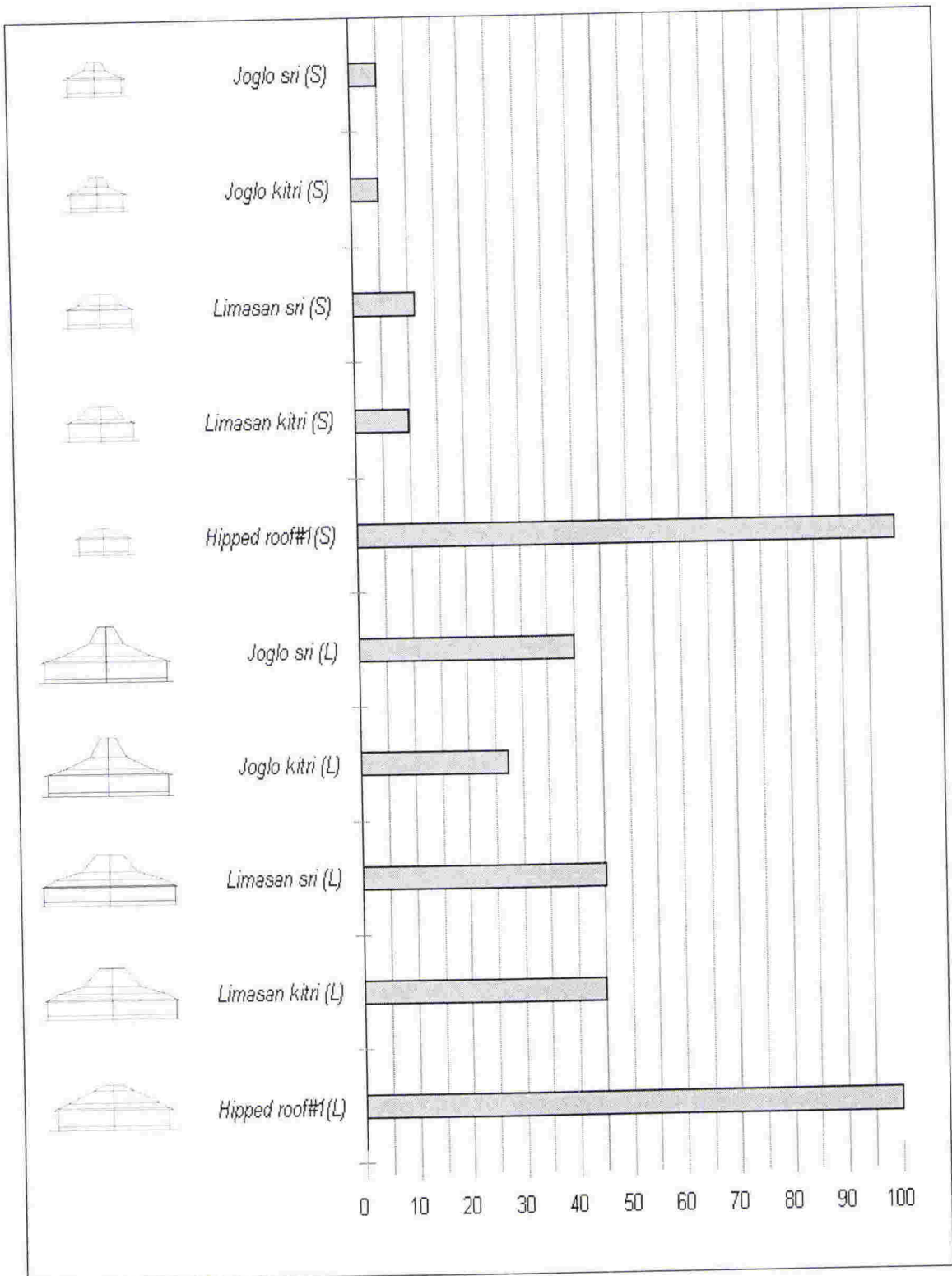

Figure 10-4 Comparison of Predicted Percentage of Dissatisfied (%). Javanese buildings are thermally comfortable. *Joglo*, *kitri* and small scale buildings create more thermally comfortable indoor air than, respectively, *Limasan*, *sri* and large scale buildings do. Styles give bigger effect of thermal comfort than *petungan* does. *Petungan* gives insignificant effects. Non-Javanese (corrugated steel-hipped roof) are thermally uncomfortable.

10.9 Relating the Experimental Results to Indoor Thermal Comfort

The experiments proved Javanese buildings of *Joglo* and *Limasan* style to be thermally comfortable. At daytime, occupants wearing typical tropical clothes (clo value = 0.3) and performing sedentary tasks (met rate = 1.0) would feel comfortable though slightly warm. Different *petungan* values and types have caused very small differences. However, in general, *Joglo* has better thermal performance than *Limasan*. Also, applying *kitri* will generally give better thermal performance than applying *sri*.

Ceilings can influence thermal comfort in two ways. First, a ceiling can partly prevent the heat of roof surfaces from transferring to indoor air. Second, ceilings at *guru* sector direct the cooler outdoor air supply through the occupants' zone. The second phenomenon was obvious through comparison of the indoor airflow pattern in small version models of *Joglo* and *Limasan* style. In the *Limasan* model, the outdoor cooler air supply was pushed upward by the buoyancy effect of the hot roof surfaces and filled the *guru* sector area. In *Joglo* style the buoyancy effect could not push the air supply up further as the ceiling of the *guru* sector blocked it. This mechanism thus improved the indoor air comfort by introducing a higher velocity and cooler air from the outdoor supply (see Figure 10-6).

The porosity of the roof has been proved very important in avoiding excessive heat gain from the hot roof to the indoor air by enabling the indoor air to ventilate. The cooler outdoor air supply prevents the indoor air temperature from rising too high. In the case of the hipped roof which uses airtight corrugated steel, without any outdoor (cooler) air supply, the indoor air temperature approaches the temperature of the roof surface. Although heat was added to the indoor air (by the hot roof), no heat was removed from it. The indoor air temperature has far exceeded the tolerable temperature for comfort. The value of cooler air supply in reducing the indoor air temperature becomes obvious through an experiment with a ventilated-hipped roof. When gaps were applied to the hipped roof, the indoor air temperature was dramatically reduced, from above 40°C to 28°C. This shows the importance of ventilation. In terms of a building without windows such as the original Javanese building designs, the non-airtight traditional clay tiles of Javanese buildings are vital. They provide continuous ventilation night and day.

10.9.1 Air Temperatures

Under average conditions (the scenario in Table 10-7) the indoor air temperature of the small version of Javanese buildings is relatively warm, between 28 and 29°C. For the large version, the indoor air temperature is slightly higher at around 29.5°C. Convection and radiation from the warm roof do not create excessive heat inside the building. It has been proved that *kitri* causes a

lower temperature than *sri*. *Joglo* has lower temperature than *Limasan*; however, the difference is negligible.

The upper zone of the building had a lower temperature than the lower zone (occupants' zone). This was because the cooler outdoor air, which was entering the building through the gaps in the roof, was induced by the stack effect of the hot air from the hot surfaces to flow upward rather than downward. This mixed air was still cooler than the air at the occupants' zone. This can be seen as both a positive and negative aspect of Javanese building design. Even without windows, Javanese buildings are comfortable; however, the cooler outdoor air supply is not used to its optimum. An experiment with a gap near the floor gave further improved thermal comfort (see Figure 10-6). The indoor air temperature of *Joglo kitri* can be reduced from 28°C to 27°C. With the wind flows from the south, the north-western part (*senhong kiwa*) and north-eastern part (*senhong tengen*) are warmer than other parts. The north part (*senhong tengah*) is cooler than other parts of the building. (see Figure 10-6 and 10-7)

10.9.2 Airflow Patterns and Velocities

Indoor air velocity in all the buildings is very low, less than 1 m/s. It is imperceptible. The airflow pattern is chaotic. The air enters through gaps in the roof, flows upward, then flows downward, sweeps the occupants' zone before flowing upward again, and escapes through the opposite gaps. This might be beneficial to controlling air pollution without necessarily introducing perceptible air movement.

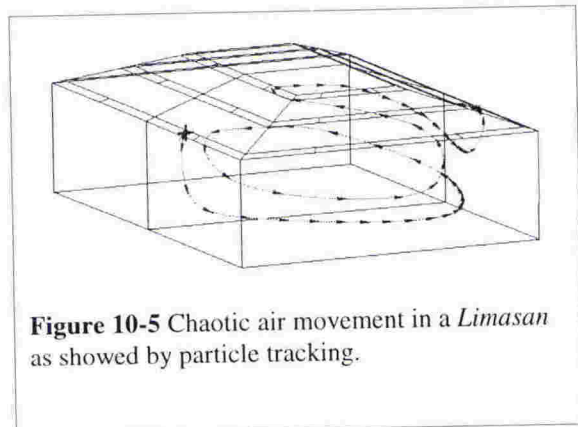

The lack of air movement inside Javanese building shows the preference of Javanese people for building as a total shelter from wind. It brings to mind the traditional Javanese wisdom that wind can do bad things to health.

10.9.3 Predicted Mean Vote and Predicted Percentage of Dissatisfied

The experiment found that Javanese buildings are comfortable with the tendency to be warm. The PMV and PPD scales identify that the indoor climate of Javanese buildings is comfortable. Figure 10-3 and Figure 10-8 show comparisons of the PMV. *Joglo* is more comfortable than *Limasan*. Small-scale buildings are more comfortable than large-scale buildings. Figure 10-8

shows various PPD inside *Joglo sri* under an average climate condition. The occupants' zone is comfortable. The figure also shows that the middle of the northern part of the building is the most comfortable location. It is the location of *senhong tengah*.

10.9.4 Air Humidity

CFD-ACE has the ability to calculate the relative humidity inside the building. When modelling atmospheric air it is often necessary to include the effect of humidity in the system. This is especially true for some HVAC (Heating Ventilation and Air Conditioning) simulations where the intent is often to control the humidity level. CFD-ACE can be used to model humidity effects by solving a mixing calculation that includes water vapour mixed with dry air. This, however, requires some manual calculations to define a mixture of dry air and water vapour to obtain the desired level of humidity. Also, it contributes to the complication of the CFD-ACE calculation that might lead to a convergence problem. To simplify the calculation, based on the field data in this experiment, the relative humidity was defined as a constant of 80% and incorporated into the PMV equation.

10.10 Javanese Building with Partitions

Javanese buildings are mostly single rooms. Figures 10-10 to 10-12 show the CFD-ACE results of *Joglo sri* (*Joglo* for *dalem*). The partitions divide the room into *senhong tengen*, *senhong tengah*, and *senhong kiwa*. All of the apertures (doors and windows) were opened.

Figure 10-11 and Figure 10-12 show that *senhong tengen* and *kiwa* is warmer than *senhong tengah* and *dalem*. Outdoor air, set to 27°C, introduces cooler air into the room. But, away from the openings the air temperature increases as a result of heat transfer from the hot roof. In the experiment without internal partitions the locations of *senhong kiwa* and *tengen* have a slightly lower temperature than *dalem*. Thus, partitions change the distribution pattern of air temperature. The air temperature is affected by the airflow. Locations with higher air velocity have a lower temperature. Stagnant locations have higher air temperature. Figures 10-13 to 10-15 shows the distribution of air velocity, including stagnant locations. Figures 10-18 and 10-19 show the path of airflow and the direction.

Clothes affect the level of thermal comfort. Figures 10-16 and 10-17 show that for people wearing minimal dress (shorts and T-shirt) *senhong tengen* (and *kiwa*) are more comfortable than *dalem*. *Dalem* will be a bit cooler. But, for people wearing trousers and shirt, *senhong kiwa* will be slightly too warm.

10.11 The Performance of Computational Fluid Dynamics Program

As in the aerodynamics experiment, in this CFD-ACE has proved to be a user-friendly and versatile program. It is not only successful in reproducing real conditions but also makes it easy to study the effect of changes such as geometry, surface temperature, and air velocity on thermal comfort.

10.12 Summary

Computer simulation using a CFD program confirmed that Javanese buildings are thermally comfortable with the tendency to be warm. They are far more comfortable than non-Javanese buildings (hipped roof buildings with corrugated steel). The key feature is the ventilated roof. It keeps the indoor air thermally comfortable even with the absence of windows. However, with the presence of windows the superiority of Javanese buildings over non-Javanese buildings is not entirely obvious, even though the latter have a much higher roof temperature than the former do. This also shows that the effect of heat radiation from hot corrugated steel can be offset by ventilation.

Other findings:

- Style only affects the thermal comfort performance slightly. *Joglo* is slightly more comfortable than *Limasan*.
- Spiritual values affect thermal comfort performance. *Kitri* has consistently created a different thermal comfort value from *sri*. Applying *kitri* creates a more comfortable indoor climate than applying *sri*. However, the difference is insignificant, as it can only be seen from CFD-ACE results.
- The clay tiles of a Javanese roof are essential for providing continuous ventilation since they are not airtight. The ventilation exists at the upper zone of the building so that it does not introduce perceptible air movement at the occupants' level. This is especially true for buildings with closed windows (as in the original Javanese building designs).
- Windows can improve the thermal performance of Javanese building. However, they introduce perceptible air movement that might be not preferred by Javanese people. It seems that original Javanese building designs do not emphasise indoor ventilation to optimise the physiological cooling effect of air movement. (Note: Javanese people have other places to take the benefit of physiological cooling effect from perceptible air movement, as in taking a nap on the veranda during a hot day.)
- Constructing gaps at floor level has been proved to increase the thermal performance as a consequence of introducing perceptible air movement.

The following chapter (Chapter Eleven) will summarise the entire study of the environmental performance of Javanese buildings and comment on the research tool.

Endnotes

¹ Awbi, H.B., 1991, Ventilation of Buildings, London: Chapman and Hall.

² McIntyre, D.A., 1980, Indoor Climate, Architectural Science Series, London: Applied Science Publisher Ltd.

³ <http://www.innova.dk/books/thermal/thermal.htm#>

⁴ These material properties are found in Mills, A.F., 1992, Heat Transfer, Boston: Irwin. δ is from field data.

⁵ Mills, A.F., 1992, Heat Transfer, Boston: Irwin, p.18.

⁶ Koenigsberger, O., Ingersol, T.G., Mayhew, A., and Szokolay, S.V., 1973, Manual of Tropical Housing and Buildings, Part 1: Climatic Design, Bombay: Orient Longman, p.286.

⁷ Mills, A.F., op.cit., p.22.

⁸ Koenigsberger, O., op.cit., p. 289.

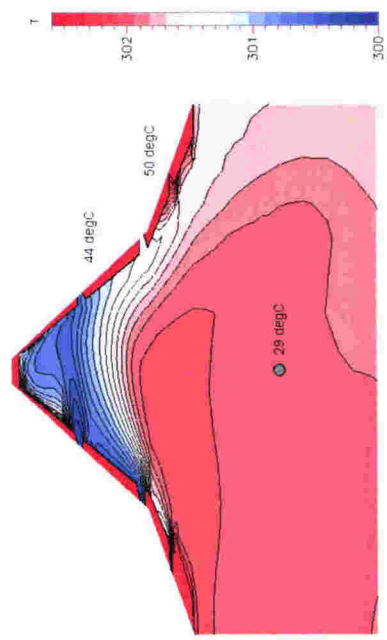

Limasan sri (S)

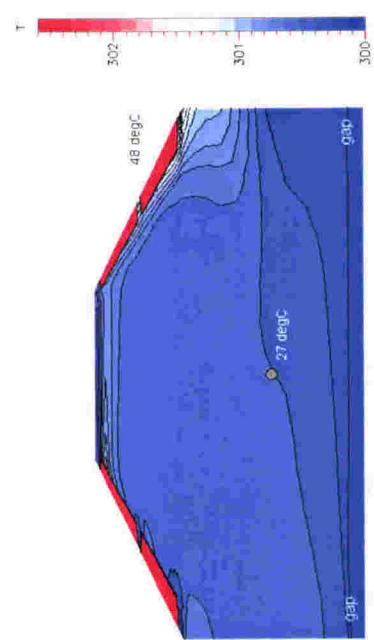

Joglo kitri (S) with gaps above floor

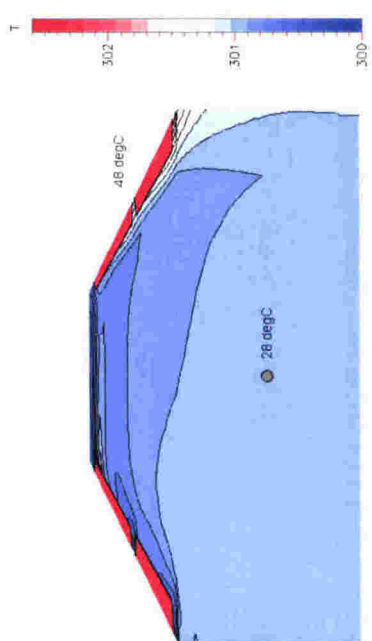

Joglo kitri (S)

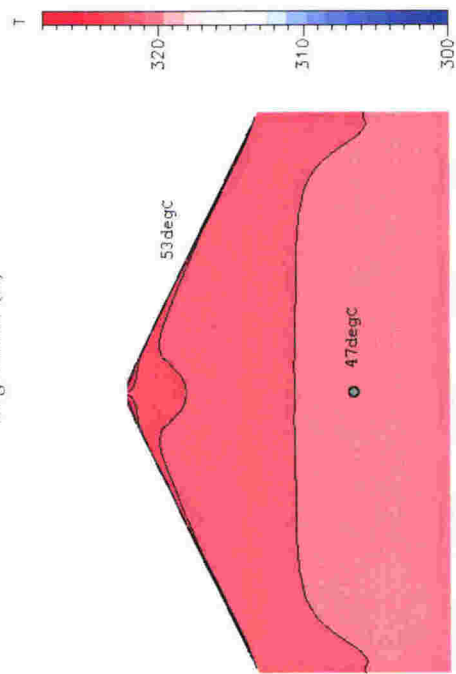

Hipped roof #1 (S)

Figure 10-6 Comparison of indoor air temperature distribution in small version models (cutting plane through the center of buildings, perpendicular to the long axis). *Joglo* has 1°C lower indoor air temperature than *Limasan*. Supplying 27°C outdoor air through gaps above the floor can reduce the *Joglo* indoor air temperature from 28 to 27°C. The indoor air temperature of the hipped roof building (with corrugated steel) rises very high.

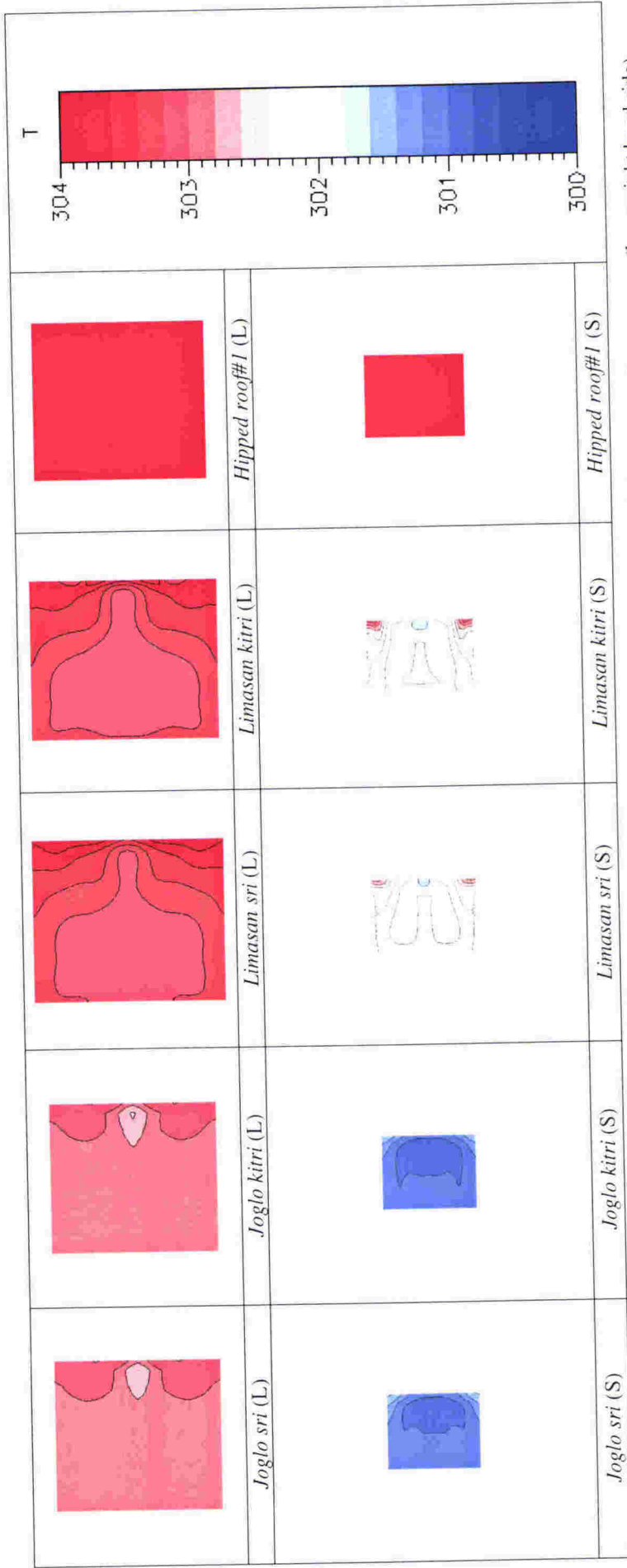

Figure 10-7 Comparison of air temperature distribution at 120 cm above the floor. *Senthong kiwa* (upper right hand side) and *senthong tengen* (lower right hand side) are warmer than other parts of the buildings. *Senthong tengah* (middle right hand side) is cooler than other parts of the building. Hipped roof buildings are evenly hot.

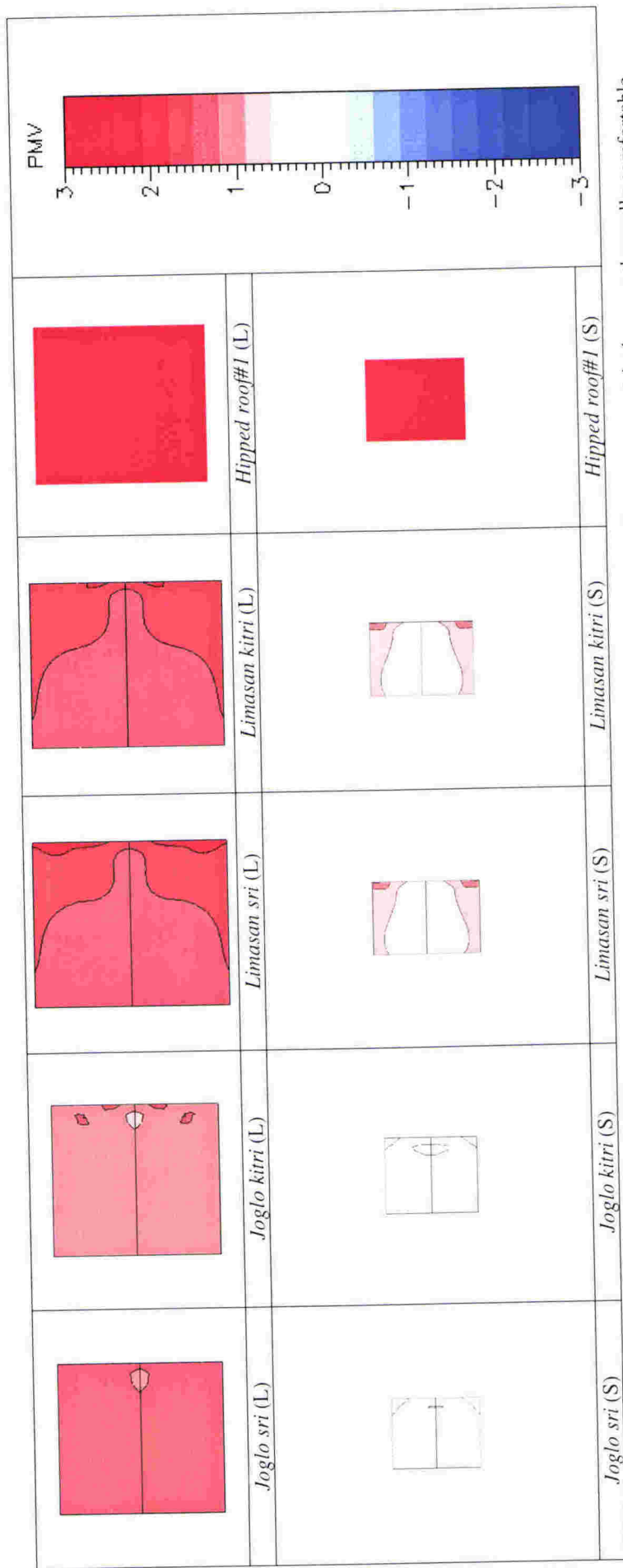

Figure 10-8 Comparison of Predicted Mean Votes (PMV) distribution at 120 cm above the floor. *Senthong tengah* (northern part) is the most thermally comfortable place. Small Javanese buildings are more comfortable than the large ones. Non-Javanese (hipped roof) buildings are thermally uncomfortable.

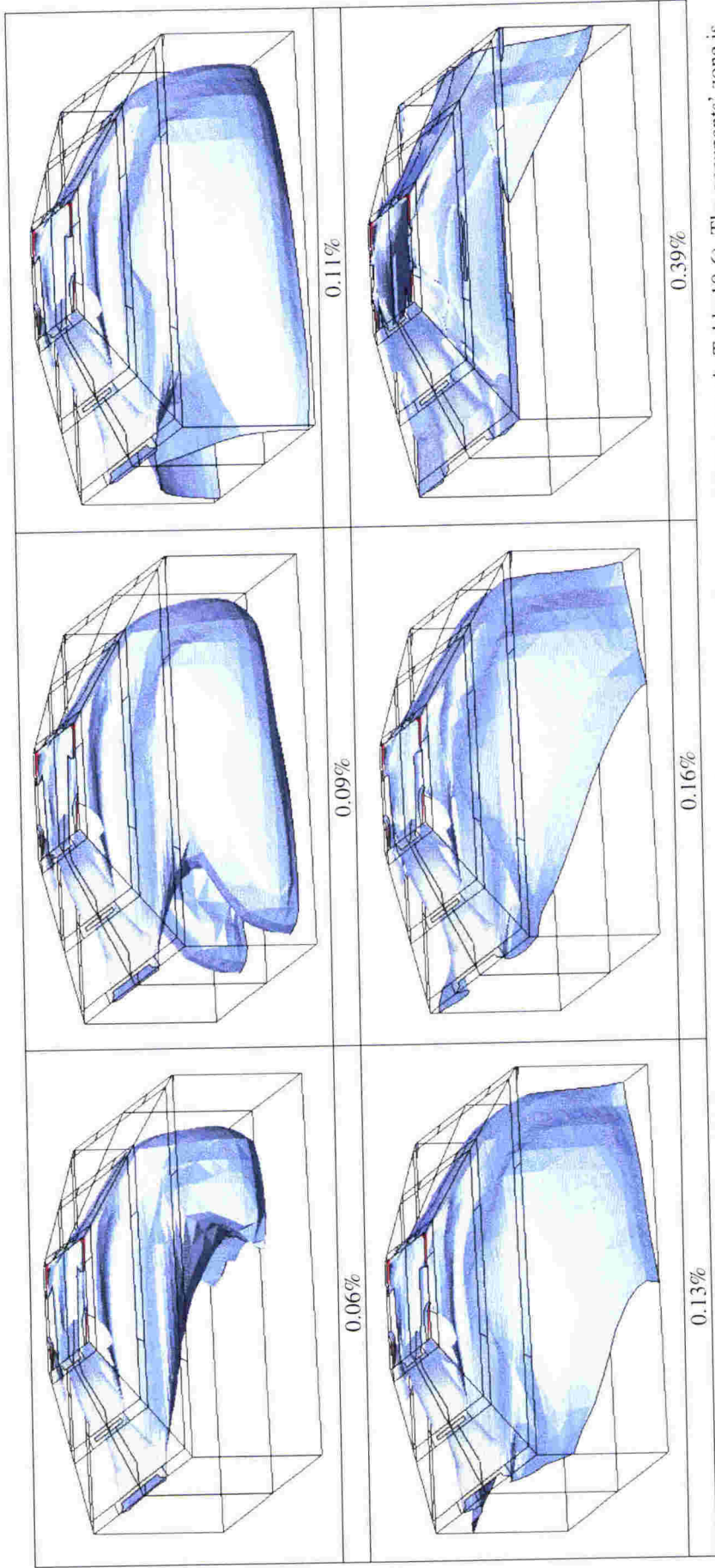

Figure 10-9 Area of various Predicted Percentage of Dissatisfied (PPD) in *Joglo sri* under an average climate condition (scenario Table 10-6). The occupants' zone is thermally comfortable. PPD = 0.39% means less than one person of a hundred will complain about the indoor climate. Location of *senhlong tengah* is the most comfortable.

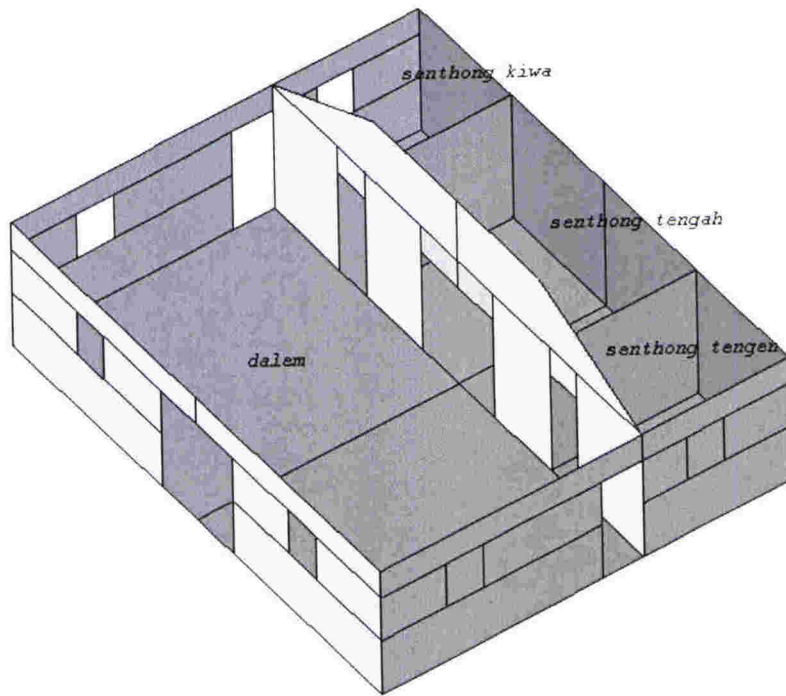

Figure 10-10 *Joglo sri* with partition.

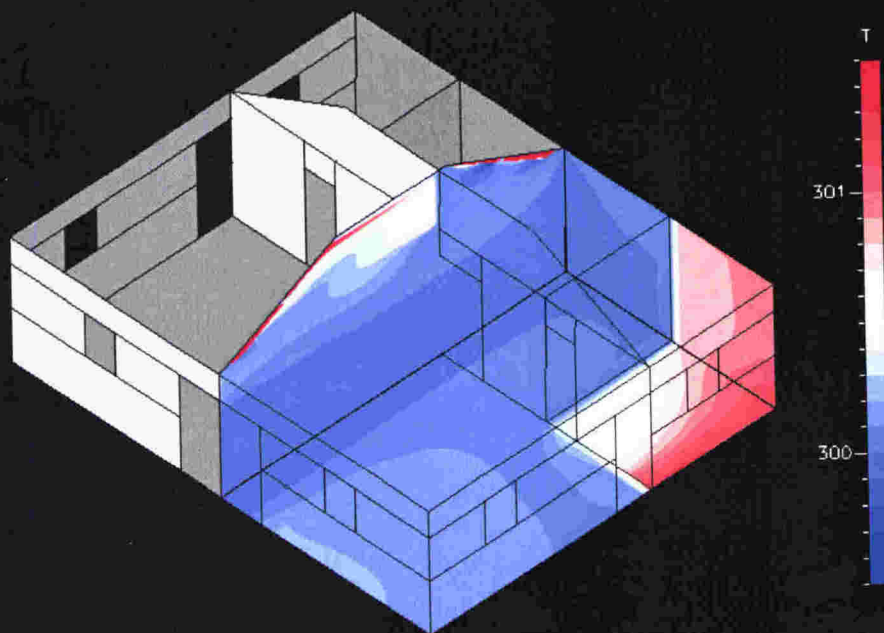

Figure 10-11 Air temperature distribution inside *Joglo sri*. *Senthong tengen* (and also *senthong kiwa*) is warmer than other parts of the building. *Senthong tengah* is cooler than other parts.

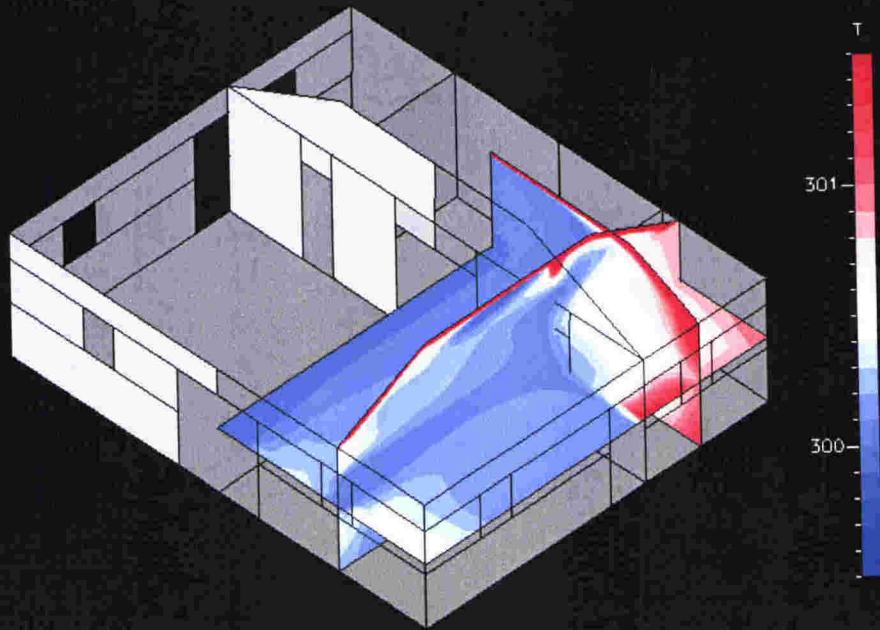

Figure 10-12 Air temperature distribution inside *Joglo sri*.

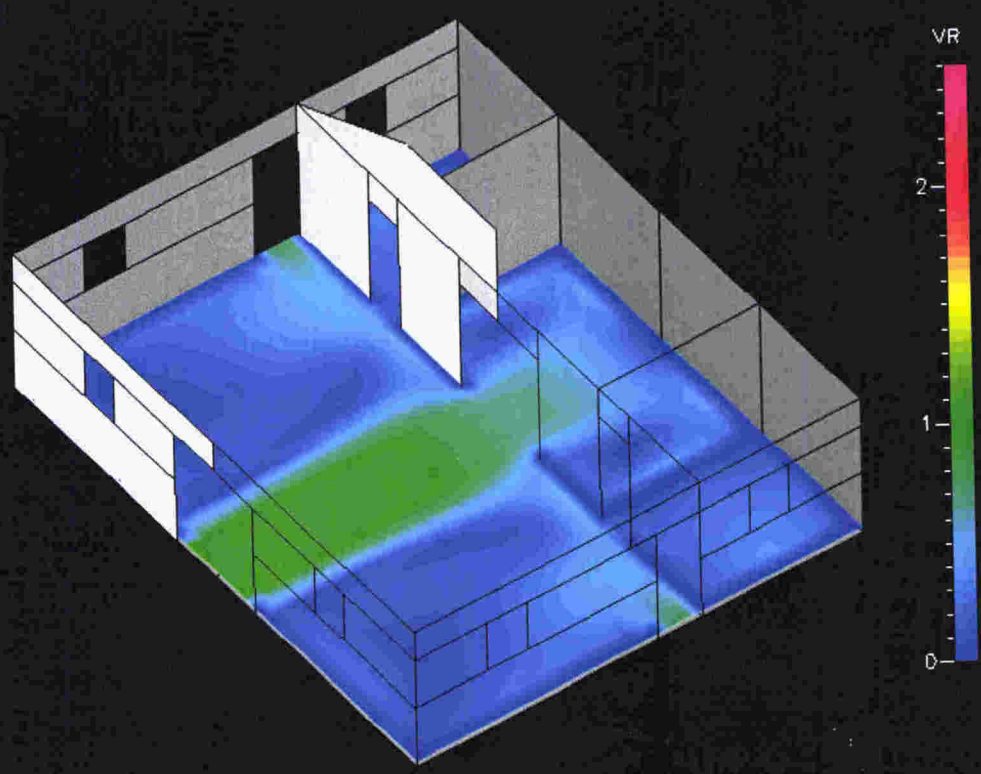

Figure 10-13 Air velocity distribution inside *Joglo sri*, 10 cm above the floor shows very low air speed at most of the places except those in the air stream from the door. The air velocity at doors and windows were based on data from the aerodynamic performance experiment.

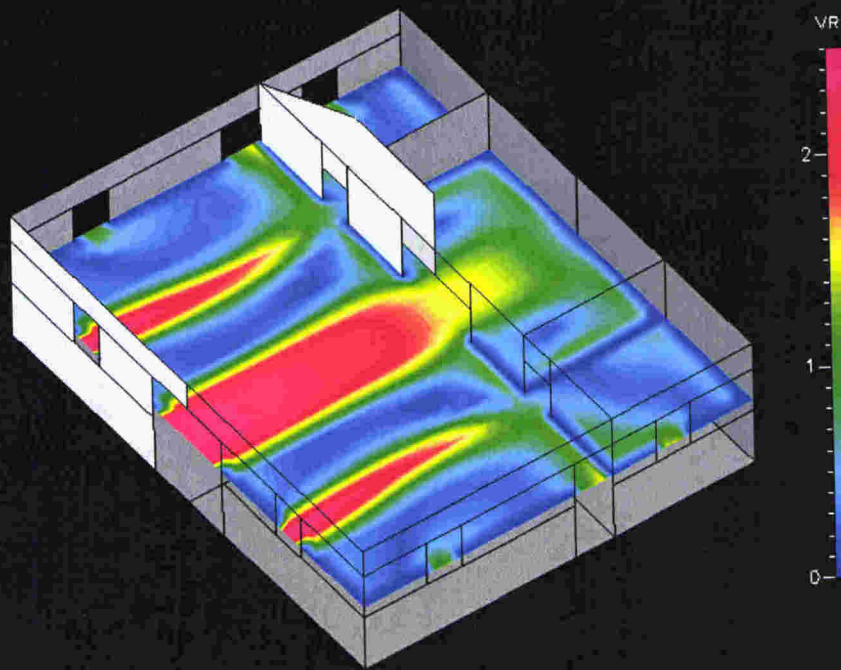

Figure 10-14 Air velocity distribution inside *Joglo sri*, 120 cm above the floor. Air velocities in *Senthong kiwa* and *Senthong tengen* are lower than those in *Senthong tengah*.

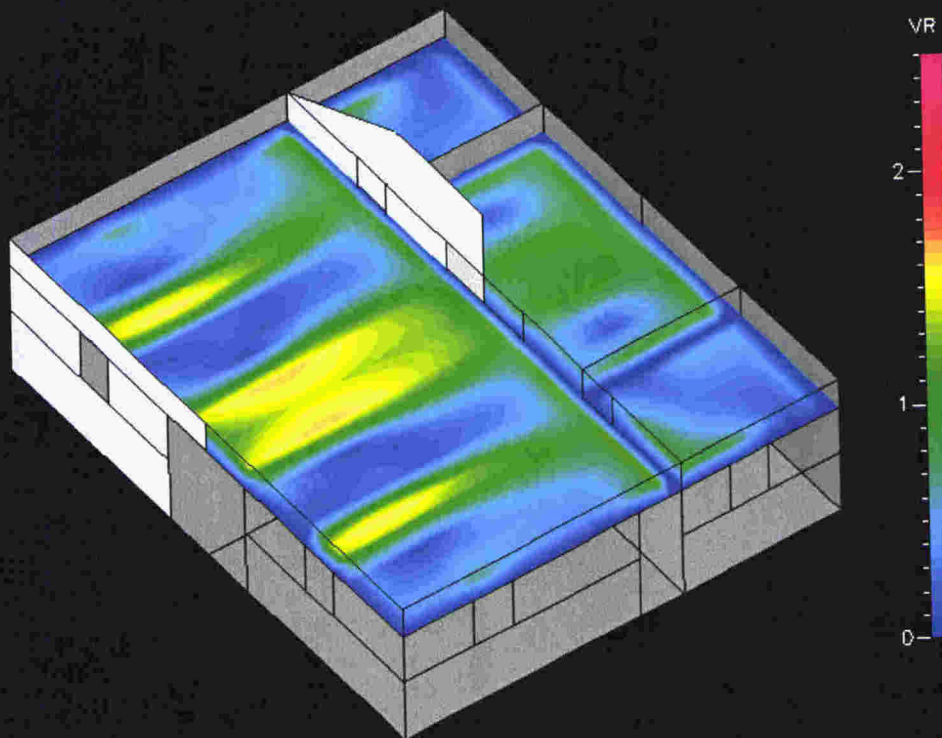

Figure 10-15 Air velocity distribution inside *Joglo sri*, 210 cm above the floor.

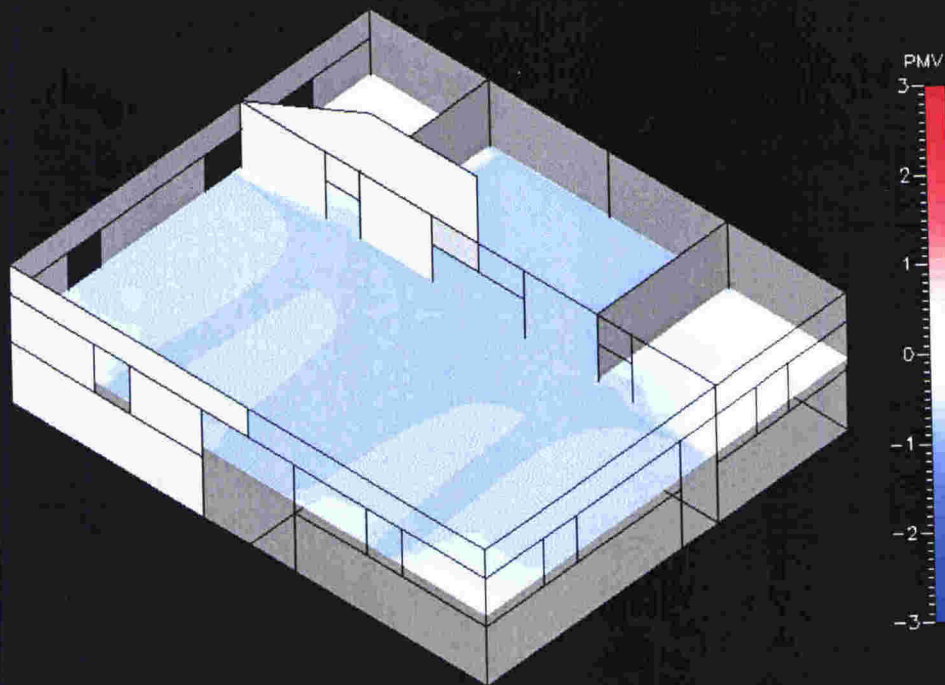

Figure 10-16 Predicted Mean Vote inside *Joglo sri* for a person wearing short and T-shirt. *Senthong kiwa* and *Senthong tengen* are thermally comfortable. Other places are slightly cool.

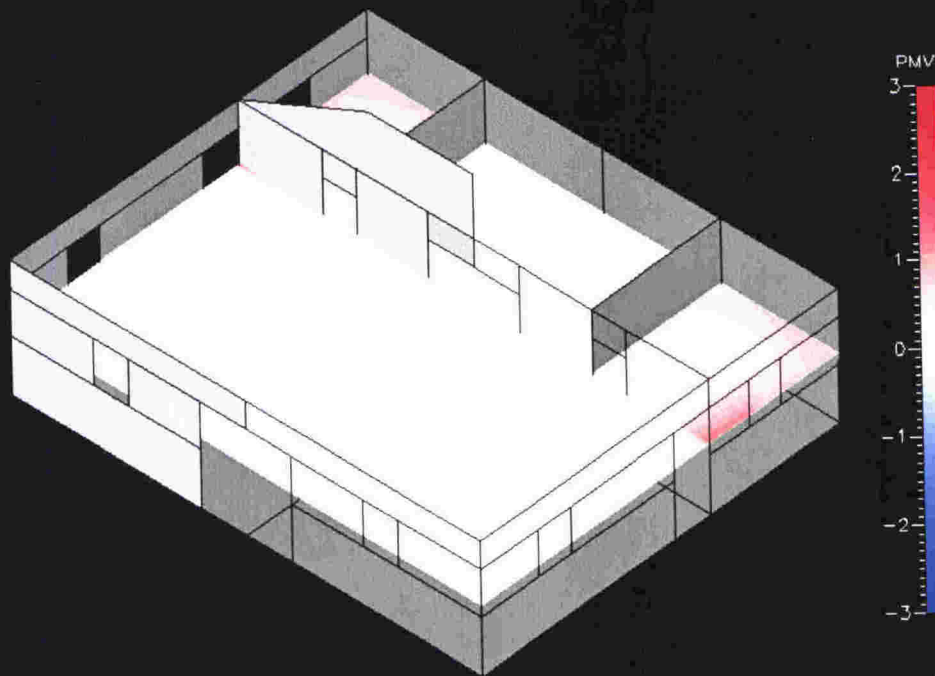

Figure 10-17 Predicted Mean Vote inside *Joglo sri* for a person doing sedentary work, wearing trousers and a long sleeve shirt. *Senthong kiwa* and *Senthong tengen* are slightly too warm. Other places are comfortable.

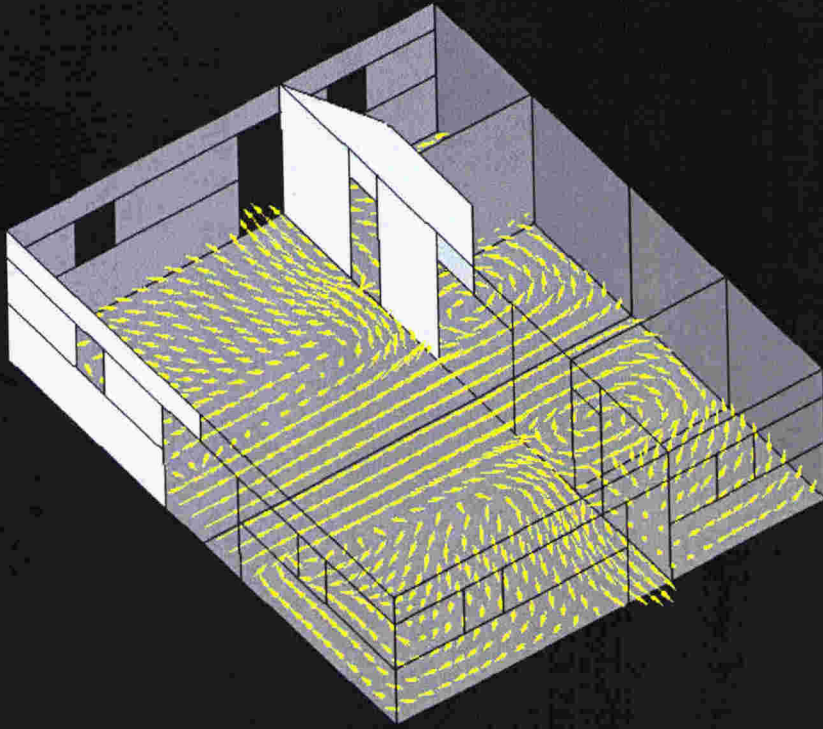

Figure 10-18 Airstream inside *Joglo sri*, at 10 cm above the floor.

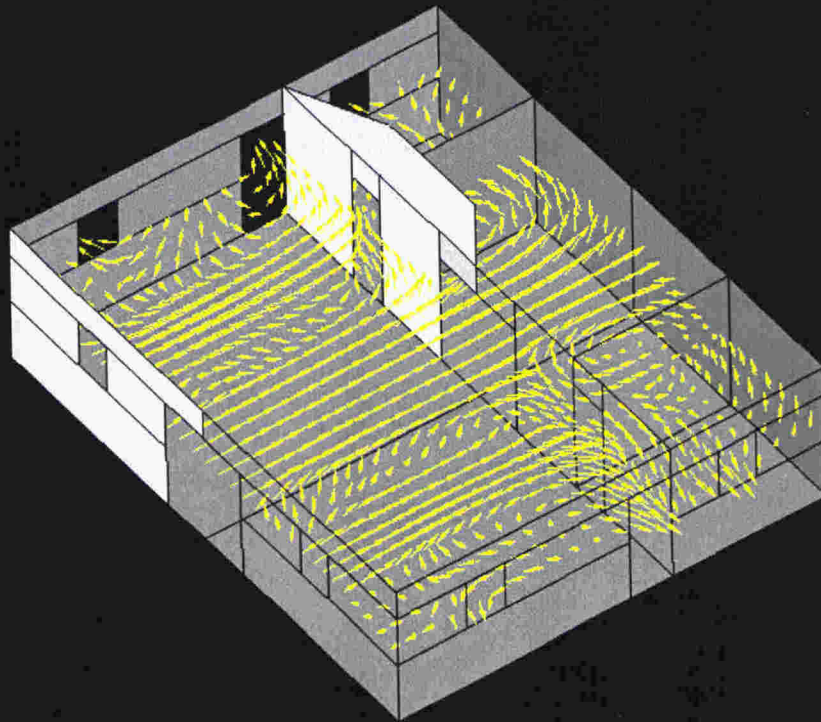

Figure 10-19 Airstream inside *Joglo sri*, at 120 cm above the floor. Vectors show the air path from the south wall's openings to the east and west walls' openings.

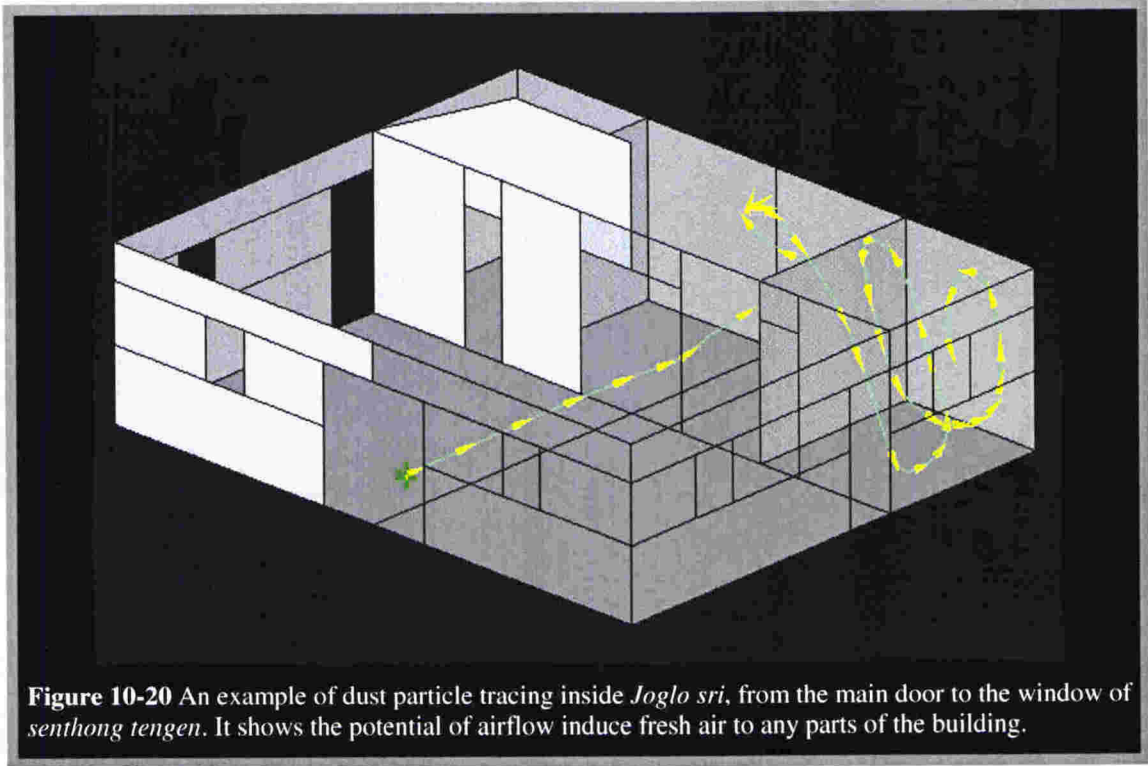

Figure 10-20 An example of dust particle tracing inside *Joglo sri*, from the main door to the window of *senthong tengen*. It shows the potential of airflow induce fresh air to any parts of the building.

11

11. CONCLUSIONS

11.1 Introduction

In this concluding chapter, the main and subsidiary questions raised at the outset are addressed under the following headings:

- Main question on Javanese building design and thermal comfort performance.
- Subsidiary questions:
 - Unique forms of Javanese architecture and thermal comfort.
 - Unique materials of Javanese architecture and thermal comfort.
 - Modelling simplification and simulation accuracy.

Some recommendations for further study are also made.

11.2 Main Question on Javanese Building Design and Thermal Comfort Performance

How do Javanese building designs contribute to thermal comfort performance?

Having explored every possibly related aspect of this question, it is now appropriate to deal with it in general.

It has been proven that traditional Javanese buildings were built according to an integrated understanding of those design features, contributing to a thermally comfortable indoor climate. While not an explicit objective within traditional design methods, the experimental results indicate a consciousness, which has informed wider building practice. Experimental data has reinforced this point, revealing traditional Javanese buildings to be comfortable, with a tendency to be warm. This study has substantiated the perception that they are more comfortable than non-Javanese buildings (represented by hipped-roof buildings, with corrugated steel roof, and no application of *petungan* values; see Figure 11-1)

The role of thermal comfort and interior climate considerations in traditional Javanese building technique is implicit rather than explicit. These considerations are revealed through scientific data linked to thermal comfort using a descriptive analysis method. The principles are inherent to the traditional Javanese building design guides found within traditional literatures (i.e. *Serat centhini*, *Primbon* and *Kawruh kalang*), presented in the forms of stories and songs. In these forms, building practice (the dos and don'ts) is linked to metaphysical considerations

resulting in good or bad luck upon the building's owner, and not to aerodynamic and thermal environmental consequences. However, studying modern building science texts pertinent to warm humid climate environmental design strategies has revealed prolific application of environmental considerations in Javanese designs. Numerical analysis methodology (using Computational Fluid Dynamic program) reinforced this descriptive observation.

Javanese building designs use a holistic (integrated) approach to thermal comfort. From the landscaping and the building orientation to the roof's form and materials, all have been adjusted to warm humid climatic conditions in order to create thermally comfortable indoor air. Despite its integrated approach, Javanese architecture focuses special attention on roofs as they reflect the styles and spiritual values of the buildings. Aerodynamic and thermal performance experiments proved that the roofs are also important contributors to indoors thermal comfort. Their forms (styles) and materials (clay tiles) act simultaneously to produce the end result, a thermally comfortable indoor climate. Using a Javanese style without also applying its unique materials will create a less thermally comfortable environment. Similarly, applying those unique materials to non-Javanese buildings will not allow the full aerodynamic benefits of Javanese styles.

Tests of aerodynamic and thermal performance shows Javanese buildings to have an integrated roof ventilation system. Finding this is consistent with the discovery that original Javanese designs did not involve the use of windows to any great extent. The experiments found the ventilation superiority of Javanese buildings over non-Javanese buildings is obvious only under those circumstances. The introduction of windows has improved the ventilation performance and the thermal comfort of Javanese buildings as well as those of non-Javanese buildings and makes the superiority of the former less significant.

11.3 Subsidiary Questions

11.3.1 The Unique Forms of Javanese Buildings and Thermal Comfort

The unique forms of Javanese buildings are a combined result of their styles and *petungan* (Javanese numerology). Both have been found to affect thermal comfort.

- The Style

In terms of styles, *Joglo* has been proved to be thermally more comfortable than *Limasan*. It has been found to have an indoor air temperature 1°C lower than *Limasan*.

The multi-angled forms of Javanese roofs create higher positive pressures at the windward surfaces, especially near the folded lines (between sectors), and creates high ventilation potential at roof level. Thus, Javanese buildings have higher ventilation potential than non-Javanese buildings (represented by single angle hipped roof buildings). This superiority is only true at roof level.

The ventilation potential from pressure differences between wall and roof level shows that Javanese buildings have relatively similar ventilation potential to non-Javanese buildings. Again, this is consistent with the original Javanese building designs, which rely on the roof ventilation rather than on windows and doors. In other words, the ventilation superiority of Javanese buildings is only obvious when there are no windows and doors opened. (See Figure 11-2)

Ceilings are important in directing the cooler outdoor air (penetrating through the roof gaps) to the occupants' zone. The presence of a ceiling at the *guru* sector of *Joglo* deflects the airflow downward. That is not the case for *Limasan* where the absence of ceiling has allowed the buoyancy effect to push the cooler incoming outdoor air up.

- The *Petungan*

In terms of spiritual values (*petungan*), *kitri* creates a more thermally comfortable indoor air space than *sri* does. However, the difference is barely significant. *Petungan* thus contributes little in the issue of superiority of Javanese buildings over non-Javanese architecture. The aspects of architectural design, which contribute to thermal comfort issues, are *not* dictated by a numerological system, but by pragmatic design choices within traditional constraints.

11.3.2 The Unique Materials of Javanese Buildings and Thermal Comfort

Traditional clay tiles are unique materials for Javanese buildings. These traditionally hand made roof materials are mostly used in residential buildings. The experiments found that the combination of low conductivity and high porosity of the traditional clay tile roofs gives advantages for buildings in hot humid climate in reducing solar heat gain. As heat insulator materials, the clay tiles' inside temperature does not rise very high (less than 51°C) under average solar radiation intensity.

Clay tiles provide gaps for continuous ventilation, which can be induced by wind force and stack effect. The experiments found that these gaps have a significant effect on thermal comfort. Without any wall openings, Javanese buildings have been proved much more

comfortable than non-Javanese buildings (hipped roof buildings with corrugated steel), since ventilation occurs at roof level. This ventilation enables the warm indoor air (caused by radiation and convection from the warm roof) to be replaced by cooler outdoor air.

The superiority of the clay tiles is particularly true in Javanese buildings when all doors and windows are closed. With doors and windows opened, the superiority becomes insignificant as the airflow from those openings dominates the occupants' zone.

Thus, all of the unique aspects of Javanese residential architectural designs can be shown to have an environmental function built into their traditional roles. When inhabited in a traditional manner, these buildings continue to be thermally comfortable, according to user-requirements.

11.3.3 Modelling Simplification and Simulation Accuracy

The CFD program has proved a reliable research tool, as shown by the aerodynamic and thermal calibration results and the experiments with the Javanese buildings. However, calibration of the program prior to its use as a research tool is strongly recommended.

The precision of data input is important for obtaining accurate results. However, unlike industrial design contexts, in building aerodynamic and thermal performance the required precision of the input can be reduced. Within a building context, usually only general ideas of phenomena are required. However, without forcing unrealistic computer, time, and labour costs, it is always worthwhile to define boundary conditions and flow domain in such a way as to simulate real conditions as closely as possible. This is particularly the case when detailed observation of small-scale phenomena in and around the building is required, such as the effect of window and door style on the airflow.

Running a CFD program with complicated data input has been proved to increase solution problems (i.e. convergence problems). It is thus wise to make the data input as simple as possible to avoid complication in model construction as well as calculation. Dividing an experiment into smaller processes could simplify the input (for example, one experiment uses the results of previous experiments as its data input and produces results to be used as data input for the next experiment). Careful attention is needed in transferring data (interpreting the results of previous experiment to be used as data input), or inaccurate results can filter through.

Modelling simplification can be applied to the geometry and the airflow models. Even though the CFD program offers various facilities to model airflow and heat transfer problem inside and around building, a selection can be made to obtain the required accuracy while keeping the model as simple as possible.

It was found that for aerodynamic performance simulation, a combination of three-dimensional model (with non-uniform grid), standard k- ϵ turbulence model, and atmospheric boundary layer is sufficient to get realistic results. For thermal performance simulation, a combination of three-dimensional model, standard k- ϵ turbulence models with convection, and radiation heat transfer is sufficient.

11.4 Recommendations for Further Research

- Further studies are also needed to explore the ventilation potential at roof surfaces. A new design might be developed based on Javanese roof design to maximise ventilation potential while minimising the negative effects (rain water spray, dust, etc.). This kind of ventilation can be very useful in high building density areas where the efficiency of window (and door) ventilation is minimised by the lack of free air movement.
- The *Joglo* style, popularly known as the symbol of Javanese architecture, has been proved more comfortable than *Limasan*. Though this research studies both styles (since residential buildings mostly use these styles), further comparative studies involving other styles (*Tajug*, *Kampung* and *Panggung pe*) might be useful. It would further justify the position of *Joglo* as the best style for thermal comfort.

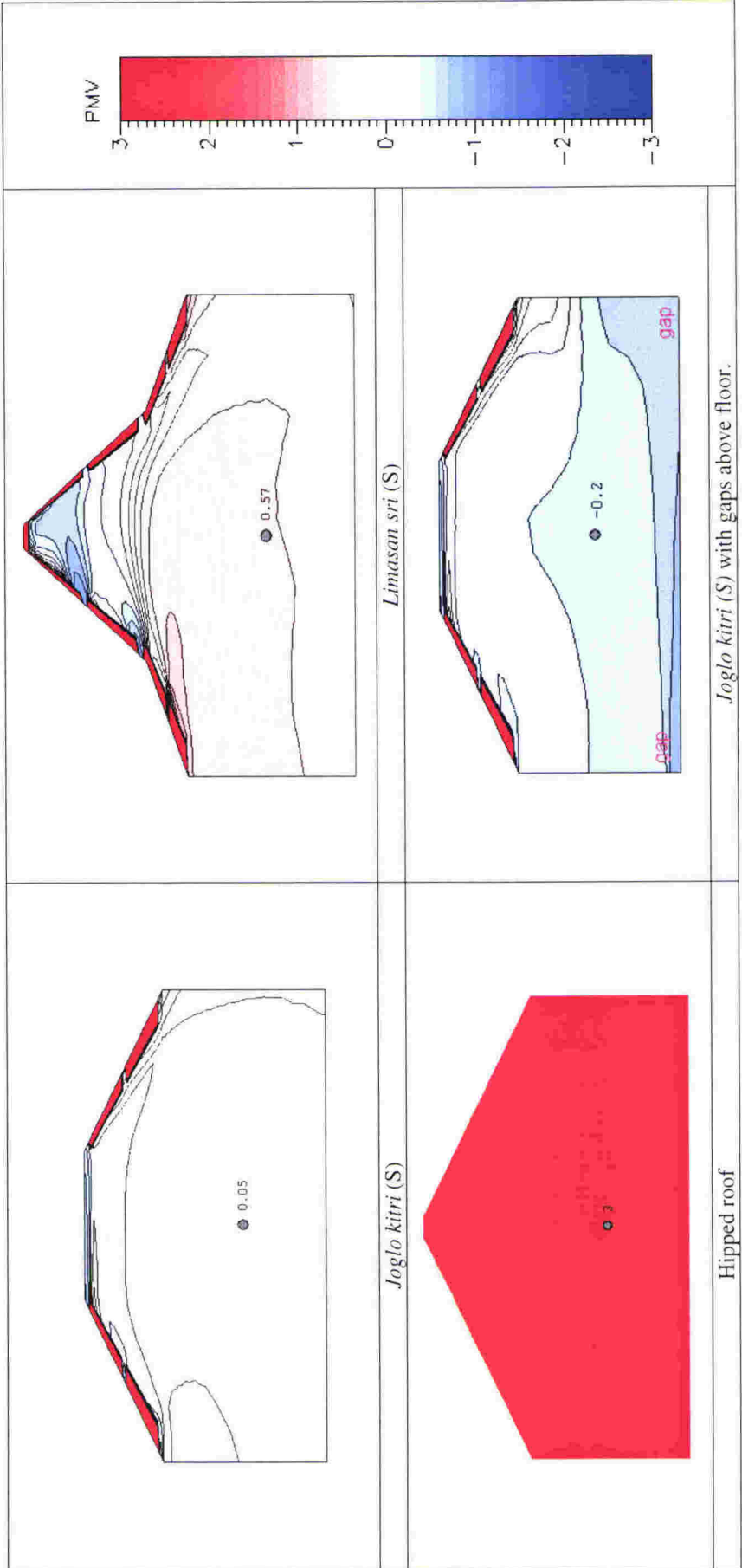

Figure 11-1 Comparison of Predicted Mean Vote (PMV) based on people who do sedentary work and wear informal tropical clothes (shorts, T-shirt, sandals). *Joglo kiiri* is thermally more comfortable than *Limasan sri*. Introducing outdoor air through gaps above floor makes *Joglo kiiri* slightly too cool. The hipped roof building (no *petungan*, corrugated steel roof) is not comfortable.

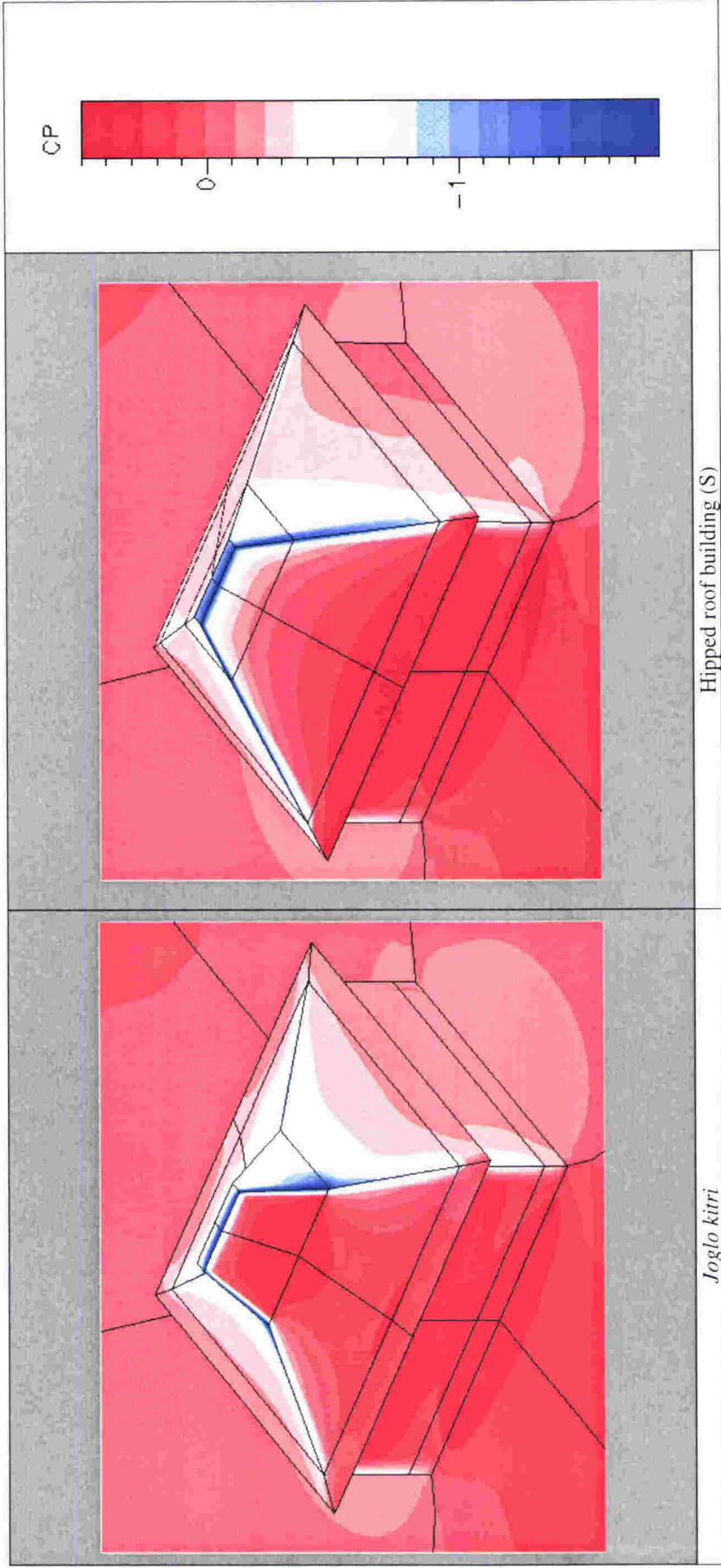

Figure 11-2 Comparison of pressure coefficient (C_p) distribution at roof surfaces of *Joglo kitri* (S) and the hipped roof building (S). Folded line between *guru* and *pananggap* sectors creates high positive pressure area. The ventilation potential at roof level of *Joglo kitri* is higher than that of the hipped roof building.

Handwritten text in a cursive script, likely a historical document or manuscript. The text is written in dark ink on aged, yellowish paper. The script is dense and fills most of the page, with some lines appearing to be part of a list or a series of entries. The handwriting is characteristic of the 17th or 18th century.

AB

A.

A.1 The Ten Buildings

The ten Javanese buildings studied are formerly owned by *lurah*. All of them are easily visually recognisable as Javanese buildings. However, no building has exactly the same form. All of them have in some degree been modified.

Table A-1 Conditions of the ten Javanese buildings.

Owners	location	Landscape	mass and plan	roof		external walls		internal walls		structure		floor		furnish- ing
				form	materials	form	materials	form	materials	form	materials	form	materials	
Samsi Wardani	Yogya-karta, in a kam-pong	Wide front yard, trees	2 masses, simple plan: <i>pendapa</i> , <i>pering-gitan</i> , <i>dalem</i> , <i>senhong</i> , <i>gandok</i> (extension)	2 <i>joglos</i> , 3 <i>limasan</i> , 1 ceiling for <i>dalem</i> with some glass tiles	clay tiles for cover, bamboo for ceiling, some corrugated steel at <i>pendapa</i>	1 m high wall at <i>pendapa</i> , simple ornamented wall for <i>dalem</i> and <i>pering-gitan</i> with small openings.	Wood, brick	simple wood partitioning for <i>senhong</i> with no door leaves (use linens)	wood, brick	traditional timber frame construction and brick wall	wood, brick	60 cm high at <i>pendapa</i> , 80 cm high at <i>senhong</i>	teraso tiles, cement	basic dining table, cupboards, beds. No heat sources except a few 15 watts lamps.
Dalidjo	Yogya-karta, in a kam-pong	Wide front yard	1 mass, simple plan: <i>pendapa</i> , <i>dalem</i> , <i>senhong</i> , <i>gandok</i> (extension)	1 <i>joglo</i> , 4 <i>limasan</i> , 1 <i>kampung</i> , ceilings for <i>pendapa</i> and <i>dalem</i>	clay tiles for cover, woven bamboos for <i>dalem</i> 's ceiling, gypsum for <i>pendapa</i> 's ceiling	simple walls mainly with doors as openings with ventilation closed, small windows to other rooms, closed all the time. Doors use glass	brick	brick wall for <i>senhong</i> with doors.	brick	traditional timber frame construction and 30 cm thick brick wall	wood, brick	30 cm high at <i>pendapa</i> , 50 cm high at <i>senhong</i>	cement	mattress on floor, bed, cupboards. Heat sources: 15 watts lamps, TV

Soesilo	Sleman, in a village	wide front yard, big trees	1 mass, simple plan: <i>pendapa</i> , <i>pering-gitan</i> , <i>dalem</i> , <i>senhong</i>	3 <i>limasans</i> , 1 <i>kampung</i> , glass tiles	clay tiles for cover	simple brick walls	brick	simple ornamented timber wall for <i>dalem</i> 's and <i>senhong</i> 's south side	timber and brick	bearing wall for <i>pendapa</i> and <i>dalem</i> , traditional timber frame for roof support	timber for roof support and partition; brick for bearing walls	1 m high simple floor	brick and cement	basic sofa, cupboards, heat sources: 25 watts incandescent lamp, 20 watt fluorescent, TV
Gotri	Sleman, in a village	wide front yard, big trees	1 mass, simple plan: <i>pendapa</i> , <i>pering-gitan</i> , <i>dalem</i> , <i>senhong</i> , <i>gandok</i>	2 <i>joglos</i> , 2 <i>limasan</i> , 1 <i>kampung</i> , glass tiles	clay tiles for cover	simple ornamented timber wall for <i>dalem</i> ' south facade and simple brick walls for the rest, no windows	timber, brick	simple ornamented timber wall for <i>senhong</i> south side	timber and brick	traditional structure for <i>pendapa</i> , bearing wall combined with timber frame for <i>dalem</i>	timber for <i>pendapa</i> and brick for <i>dalem</i>	simple floor, 50 cm high	cement	basic sofa, cupboards, heat sources: 25 watts incandescent lamp, 40 watt fluorescent, TV

Dwi Putranti	Yogyakarta	no front yard, busy road at the east side and less busy road at the south side.	1 mass, simple plan: <i>pendapa</i> , <i>pering-gitan</i> , <i>dalem</i> , <i>senhong</i>	2 <i>joglos</i> , 1 <i>limasan</i> , ceiling for <i>dalem</i> with glass tiles	clay tiles for cover, multiplex for ceiling	simple wall at the east side of <i>pendapa</i> (street side) with no openings, simple ornamented timber walls for <i>pering-gitan</i> , many windows	multiplex for wall at the street side of <i>pendapa</i> ,	simple timber wall, doors with leaves, except <i>senhong tengah</i>	timber	traditional timber frame	timber	simple floor, 30 cm high	cement tiles	chairs and tables, cupboards, Heat sources: TV, computer, stereo, 40 watts incandescent lamp, 40 watts fluorescent
Soekiman	Sleman, in a village	wide front yard, big trees	1 mass, simple plan: <i>pendapa</i> , <i>pering-gitan</i> , <i>dalem</i> , modified <i>senhong</i>	2 <i>joglos</i> , 1 <i>limasan</i>	clay tiles for cover	simple brick walls for <i>pendapa</i> 's west and south facade with large timber openings	brick, timber	only <i>senhong kiwo</i> left with 2 m high partition	timber	bearing walls, traditional timber frame for roof support	wood, brick	60 m high simple floor	modern ceramic tiles for <i>dalem</i> , cement for <i>pendapa</i>	chairs, tables, beds, cupboards, Heat sources: 15 watts lamp, TV
Djadi	Sleman, in a village	wide front yard, big trees	1 mass, simple plan: <i>pendapa</i> , <i>pering-gitan</i> , <i>dalem</i> , modified <i>senhong</i>	1 <i>joglo</i> , 1 <i>limasan</i>	clay tiles for cover	simple brick walls for <i>dalem</i> 's south facade with doors	brick, timber	simple timber partition for <i>senhong</i> 's south facade	timber	bearing walls, traditional timber frame for roof support	wood, brick	60 m high simple floor	cement	unoccupied

Hadi Suyitno	Sleman, in a village	wide front yard, trees,	2 masses, simple plan: <i>pendapa</i> , <i>pering-gitan</i> , <i>dalem</i> <i>senthong</i>	1 <i>joglo</i> , 2 <i>limasan</i> , glass tiles	clay tiles for cover, bamboos for ceilings	simple ornamented brick walls, small openings always closed	brick	simple timber partition for <i>senthong</i> 's south side	timber, brick	traditional timber frame for roof support, bearing walls	wood, brick	1 m high simple floor	cement	chairs, tables, beds, cupboards. Heat sources: 15 watts lamp, TV
Sukabsir	Sleman, in a village	wide front yard, big trees	2 masses, simple plan: <i>pendapa</i> , <i>pering-gitan</i> , <i>dalem</i> <i>senthong</i>	2 <i>joglos</i> , 3 <i>limasan</i>	clay tiles for cover, bamboos for ceilings	2 m high woven bamboos for <i>pendapa</i> 's west, east, and some parts of north sides; brick walls for <i>dalem</i> , with large doors and windows at the south facade closed most of the time.	Woven bamboos, timber, brick	timber wall for south side of <i>senthong</i> with doors, no door leaves	timber plank, multiplex, brick	traditional timber frame for <i>pendapa</i> , combination of brick bearing walls and timber frame for <i>dalem</i>	timber, brick	60 cm high simple floor	cement	basic sofas, cupboards, beds. No heat sources except 15 watts incandescent lamp and 40 watts fluorescent

Hadi Prasetyo	Yogyakarta, in a kampong	no front yard	1 mass, simple plan: <i>pendapa</i> , <i>pering-gitan</i> , <i>dalem</i> , <i>senhong</i>	1 <i>joglo</i> , 2 <i>limasan</i> , ceiling for <i>dalem</i> with glass tiles	clay tiles for cover, woven bamboos for <i>dalem</i> 's ceilings	ornamented walls with openings, woven bamboos partitions for <i>pendapa</i> 's north, west sides.	Woven bamboos, timber, brick	timber wall for south side of <i>senhong</i> with doors, no door leaves	Timber	traditional timber frame for <i>pendapa</i> , combination of brick bearing walls and timber frame for <i>dalem</i>	timber, brick	60 cm high simple floor	cement	basic sofas, cupboards, mattress on floor. Heat sources: 15 watts incandescent lamp and 40 watts fluorescent, TV
---------------	--------------------------	---------------	---	---	--	---	------------------------------	---	--------	--	---------------	-------------------------	--------	--

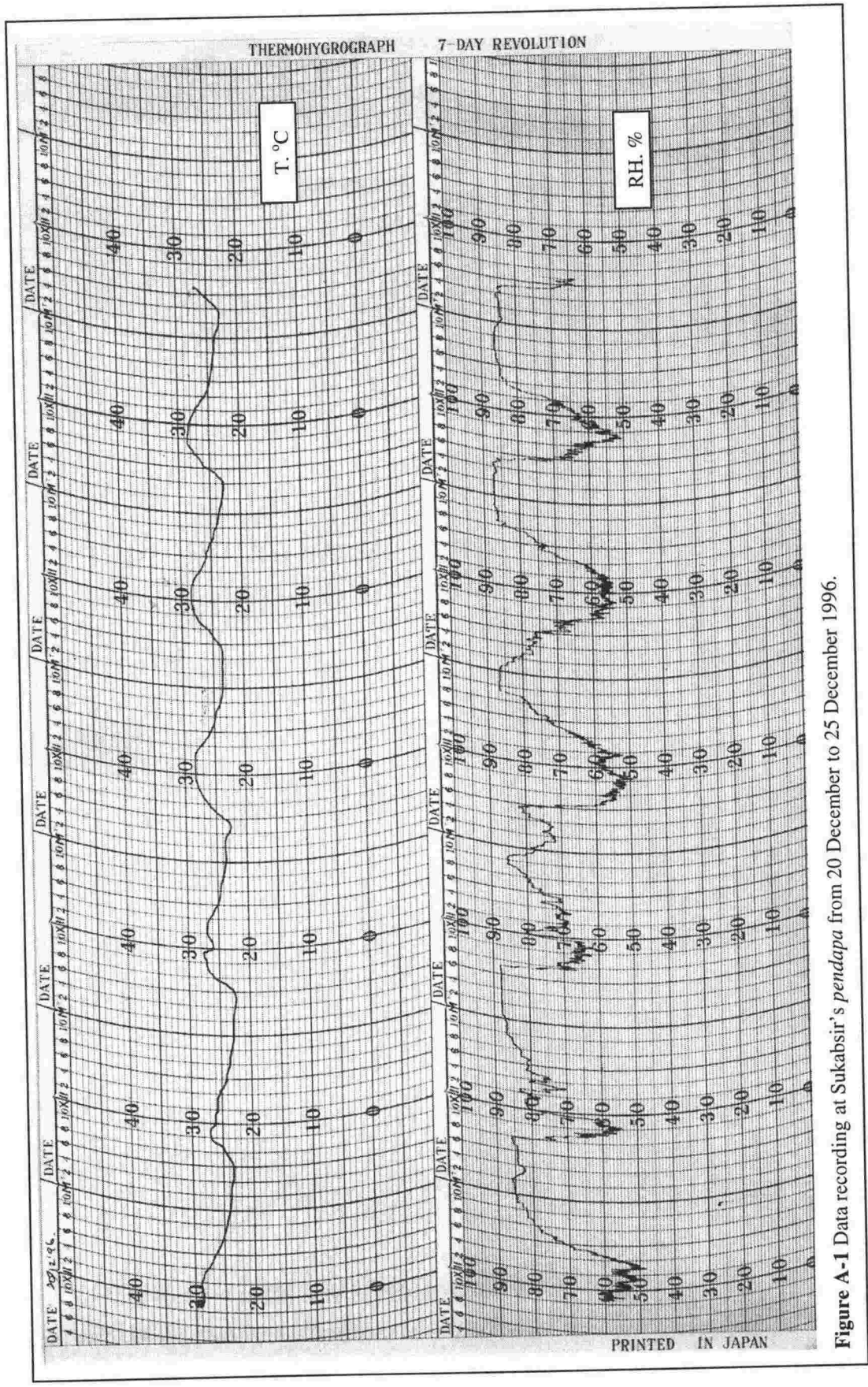

Figure A-1 Data recording at Sukabsir's pendapa from 20 December to 25 December 1996.

A.2 The Six Related Aspects of Thermal Comfort

In this research, evaluation of thermal comfort uses six related aspects and methods available through references: air temperature, air velocity, air humidity, Mean Radiant Temperature (MRT), clothing values (clo), and metabolic rates (met) are mostly used.

During field observation, it was found that air temperatures, humidity, and air movement in *pendapa* and *dalem* followed a periodical pattern. Table A-2 shows a resume of thermo-hygrographs taken from four Javanese buildings.

There was no indication that *pendapa* always have lower air temperatures than *dalem* or vice versa. In Wardani's and Sukabsir's houses, the *pendapa* tends to have lower air temperatures than the *dalem*, whereas in Prasetyo's and Suyitno's houses the *pendapa* tends to have higher air temperatures than the *dalems*. There are two probable explanations. First, Wardani's and Sukabsir's *dalem* have more glass tiles than Prasetyo's and Suyitno's *dalem*. Considering the constancy of sky conditions during the observation (sunny days), Prasetyo's and Suyitno's *dalem* were darker than the other two. Second, the Prasetyo's and Suyitno's *dalem* have only small openings, which were closed during the observation. Additionally, all four *dalem* have relatively the same heat sources: TV, radio, lamps and most of the time only one person (or perhaps two people) as occupant(s). The activities were also similar: watching TV, chatting, and sleeping.

Pendapa tend to have a larger amplitude of air temperatures (ranging between maximum and minimum air temperatures) than *dalem*. This is easily explained, as *pendapa* are more open to outdoor air than *dalem*.

An illustration of daily humidity cycles in a Javanese building can be seen from Figure A-1. The measurement was held at the *pendapa* as it is relatively open to the surrounding weather. Recording at Sukabsir's *pendapa* from 20 December 1996 to 25 December 1996 found that RH were between 50 and 88%. The less humid air is around mid-day and the most humid is around mid-night. A sharp fluctuation was caused by rain. A record from 8 December 1996 to 12 December 1996 in Prasetyo's *pendapa*, situated within the city, shows that maximum and minimum air temperatures are 28°C (at around 13:00) and 23.5°C (at around 06:00) respectively. Measurement conducted at Suyitno's *pendapa* between 14 December 1996 and 19 December 1996 found the maximum and minimum air temperatures were 28°C and 23°C. Suyitno's house is rurally situated (about 18 km from Yogyakarta). Data recording at Sukabsir's *pendapa* from 20 December to 25 December 1996 found the maximum and minimum air temperatures were

28.5°C and 22.2°C. Sukabsir's house is located 5 km from Suyitno's house. Measurements were conducted at *pendapa*, being relatively exposed to weather changes.

Table A-2 Climatic data in *pendapa* and *dalem*.

Owners			Wardani		Prasetyo		Suyitno		Sukabsir	
air temp.	<i>pendapa</i>	max.	30.2	13:00	28.2	13:00	28.8	12:00	28.2	12:00
		min.	23.5	06:00	23.2	06:00	23.0	06:00	22.2	05:00
	<i>dalem</i>	max.	32.5	13:00	27.0	13:00	27.2	15:00	28.8	14:00
		min.	24.2	05:00	24.5	06:00	24.0	06:00	24.1	06:00
humidity	<i>pendapa</i>	max.	84.5	06:00	90	08:00	88	04:00	88	01:00
		min.	53.5	14:00	67.5	13:00	57	12:00	50	12:00
	<i>dalem</i>	max.	86	02:00	95	09:00	91.5	12:00	91	08:00
		min.	46	12:00	84	05:00	77	18:00	64	14:00
air speed	<i>pendapa</i>	max.	4.5	12:00	5.1	12:00	4.2	12:00	3.9	12:00
		min.								
	<i>dalem</i>	max.	4.5	12:00	2.1	12:00	1.8	12:00	1.2	12:00
		min.								
MRT	<i>pendapa</i>	max.	30.95	12:00	28.4	12:00	29.42	12:00	29.3	12:00
		min.								
	<i>dalem</i>	max.	32.86	12:00	27.4	12:00	27.71	12:00	29.42	12:00
		min.								

Note: This table is based on the field measurement. It is used to give a rough idea on the real condition of Javanese buildings only. It is not intended to be used as a comparison between the buildings' thermal performance. Too many variables were involved which might result in a misleading interpretation. Some of the reasons that discourage the comparison are: measurements were taken at different times, all four buildings' have differences (furniture arrangement, equipment type, window configuration, etc.) which might induce various effects on thermal performance, making conclusion difficult.

Data recording at Susilo's *pendapa* shows a slightly different air temperatures. The detected maximum and minimum air temperatures 16 November 1996 and 21 December 1996 were 25.5°C (at around 13:00) and 20°C (at around 06:00). Susilo's house is situated near Pakem, 22 km north from Yogyakarta (see Figure 3.2 for Yogyakarta Special Region).

Figures in the above table were based on data recording using thermohygrographs (for air temperature and humidity), a kata thermometer (for air velocity), and a black globe thermometer (for MRT). The air velocities were derived from the following formula¹:

$$V = \left[\frac{\frac{H}{T-t} - a}{b} \right]^2$$

where

V	= air velocity, ft/min.
H	= kata thermometer cooling power, i.e. the kata factor divided by the average cooling time, in second.
T, a, b	= constants depending on the type of instrument used
t	= air temperature, °F

The MRT used the following formula²:

$$T_s^4 \times 10^{-9} = T_G^4 \times 10^{-9} + 0.1028 \sqrt{v} (t_g - t_a)$$

where

T_s	= MRT, °F Abs.
T_G	= temperature of globe thermometer, °F Abs.
t_g	= temperature of globe thermometer, °F
	$T_G = t_g + 460$
t_a	= temperature of air, °F
v	= air velocity, ft./min.

A.3 Simple thermal comfort evaluation

The following is an example involving a simple thermal comfort evaluation of the past condition of a Javanese building. It was just a common quiet day in the village. The time was 01:00 p.m. and the sun was shining. There were scattered clouds; the breeze blew gently. A peasant (not so rich farmer) took a short break after working in the rice field the whole morning. He sat in the *dalem* (with the door opened), relaxed, and had a cup of after lunch tea.

Analysis:

The peasant house was in a village. It was a one-unit building, surrounded by trees. The walls were made of timber plank and the roof used clay tiles. It did not have any ceiling. The peasant called his house the *dalem* which was a *limasan* type. At 01:00 p.m. the sun was high. Thus, walls were shaded by the overhangs. This makes the roof the only part of the building that receives direct solar radiation. But, the clay tiles were good insulators and, as they were not

perfectly matching each other, they had a good ventilation that could reduce the heat accumulation. So, the mean radiant temperature could be kept low (MRT ~ 29°C). He left the door open. This enabled the breeze to enter his house, although its speed was reduced (V ~ 0.15 m/s). The air temperature (T ~ 28°C) and the humidity were normal for the afternoon (RH ~ 60%). The peasant wore his *working clothes*, consisting of a T-shirt and shorts (clo ~ 0.18). As other common peasants, he liked having bare feet rather than using sandals. It was very muddy in the rice fields.

Figure A-1 shows a simple thermal comfort evaluation. It concludes that the condition was thermally comfortable (within ISO standards) even though it was warm, humid, and calm. In this quick check the default physiological data (skin temperature, body surface area, etc.) are used.

Table A-3 An example of data for a simple thermal comfort evaluation.

Factor	Condition	Values
Clo	T-shirt and short	0.18
Met	seated	1.0
V	light breeze	0.15 m/s
T	Sunshine with scattered clouds	28°C
RH	Common condition at noon	60%
MRT	walls shaded	29°C

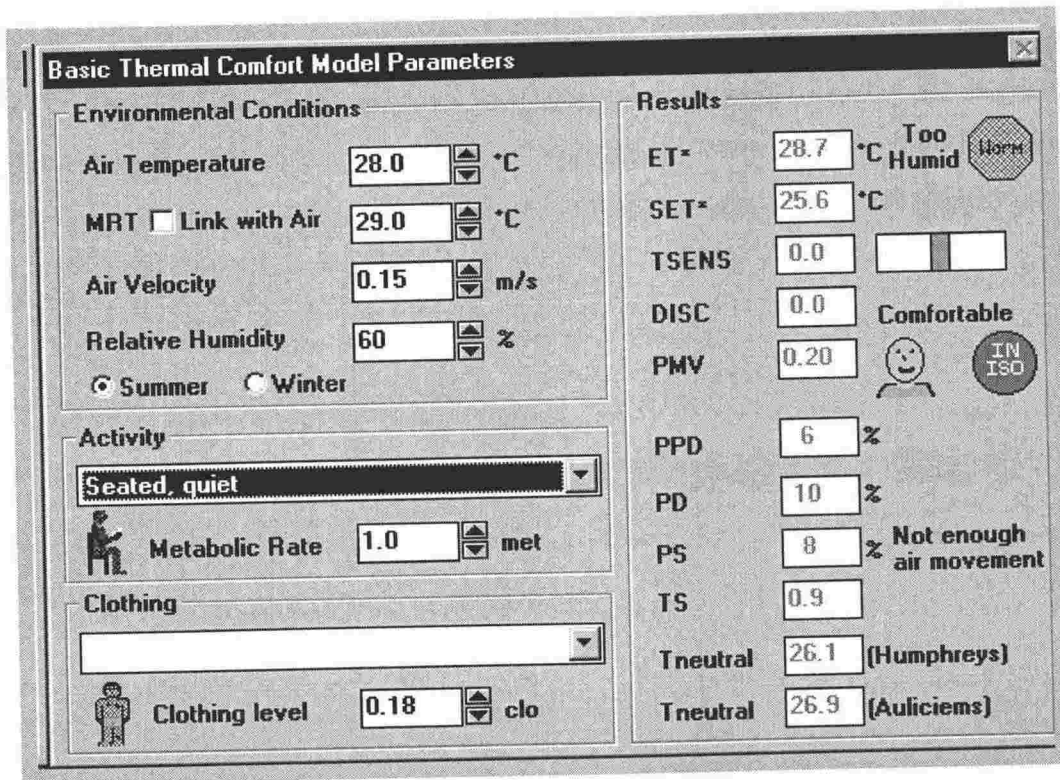

Figure A-1 An example of a simple evaluation to the data presented at Table A-3.

Endnotes

¹ Bedford, T., 1984, *Basic Principles of Ventilation and Heating*, London: H.K. Lewis & Co. Ltd., p.26.

² Ibid., p.38.

B.

- Field Research Equipment:
 - Kata thermometer (for very low air velocity)
 - Anemometer (for low to high air velocity)
 - Wallac thermometer (for surface temperature)
 - Black Globe thermometer (for mean radiant temperature)
 - Whirling hygrometer (for humidity)
 - Thermo-hygrograph (for 24 hours and 7 days measurement of humidity and air temperature)
 - SLR Camera + flashlight
 - Barometer (for location height above the sea level)
 - Ruler
- Computer Research Equipment
 - Monitor: Sony Trinitron Multiscan17sfII
 - CPU: Pentium 166, 256 MB RAM
 - Environment: Windows NT, Networking
 - Software for experiment: CFD-GEOM, CFD-GUI, and CFD-VIEW (ver. 4.0 pack)
 - Other software: Corel Quattro Pro 8, Microsoft Word 7, Systat 5, AutoCAD 14, Adobe Photoshop 4.0, ASHRAE Thermal Comfort Program, Microsoft WordPad 4.0.
- Example of data input for experiment of thermal performance – interior model:

```
TITLE ' ' Joglo kitri large version - interior "
*
*
*
*
*
***** Model *****
*
*
MODEL jkh1-intf
*
GEOMETRY
  GRID 3D BFC
  USE GRID FROM jkh1-intf.DTF DTF
* Cell Types
END
*
PROBLEM_TYPE
  SOLVE FLOW TURBULENCE HEAT RADIATION
* Steady flow
END
*
PROPERTIES
  DENSITY GAS_LAW PRESS 100000 MOL_WT 29
  VISCOSITY CONSTANT_KINEMATIC 1.59e-005
  SPECIFIC_HEAT 1005
  CONDUCTIVITY PRANDTL 0.69
  PRT 1
  RADIATION EMISS = 0.9 ABSOR = 0 SCATTER = 0
```

END

*

MODELS

TURBULENCE_MODEL KE

RADIATION_MODEL S4_AAQ

END

*

*** Boundary Conditions ***

*

BOUNDARY_CONDITIONS

* Gravity boundary condition specified

GRAV_X 0

GRAV_Y -9.8

GRAV_Z 0

RHOREF 1.177

* boundary condition: Default

WALL 1 1 50 62 1 12 WEST

U = 0 V = 0 W = 0 RH = 0.005 T = 321

* boundary condition: Default

TOTAL_P_CART 1 1 63 65 1 6 WEST

U = 1 V = 0 W = 0 P = 2.788 K = 0.505 D = 0 L = 0.2 T = 300

* boundary condition: Default

WALL 1 1 63 65 7 12 WEST

U = 0 V = 0 W = 0 RH = 0.005 T = 321

* boundary condition: Default

WALL 1 1 47 49 7 12 WEST

U = 0 V = 0 W = 0 RH = 0.005 T = 321

* boundary condition: Default

TOTAL_P_CART 1 1 47 49 1 6 WEST

U = 1 V = 0 W = 0 P = 2.625 K = 0.505 D = 0 L = 0.2 T = 300

* boundary condition: Default

WALL 1 1 34 46 1 12 WEST

U = 0 V = 0 W = 0 RH = 0.005 T = 321

* boundary condition: Default

TOTAL_P_CART 1 1 31 33 1 6 WEST

U = 1 V = 0 W = 0 P = 2.211 K = 0.505 D = 0 L = 0.2 T = 300

* boundary condition: Default

WALL 1 1 31 33 7 12 WEST

U = 0 V = 0 W = 0 RH = 0.005 T = 321

* boundary condition: Default

WALL 1 1 18 30 1 12 WEST

U = 0 V = 0 W = 0 RH = 0.005 T = 322

* boundary condition: Default

WALL 1 1 15 17 7 12 WEST

U = 0 V = 0 W = 0 RH = 0.005 T = 322

* boundary condition: Default

TOTAL_P_CART 1 1 15 17 1 6 WEST

U = 1 V = 0 W = 0 P = 1.974 K = 0.505 D = 0 L = 0.2 T = 300

* boundary condition: Default

WALL 1 1 1 14 1 12 WEST

U = 0 V = 0 W = 0 RH = 0.0001 EM = 0

* boundary condition: Default

EXIT_P 19 19 63 65 1 6 EAST

U = 0 V = 0 W = 0 P = -3.1 K = 0.505 D = 0 L = 0.2 T = 300

* boundary condition: Default

WALL 19 19 63 65 7 12 EAST

U = 0 V = 0 W = 0 RH = 0.005 T = 321

* boundary condition: Default

WALL 19 19 50 62 1 12 EAST

U = 0 V = 0 W = 0 RH = 0.005 T = 321

* boundary condition: Default

EXIT_P 19 19 47 49 1 6 EAST

U = 0 V = 0 W = 0 P = -3.8 K = 0.505 D = 0 L = 0.2 T = 300

* boundary condition: Default

WALL 19 19 47 49 7 12 EAST

U = 0 V = 0 W = 0 RH = 0.005 T = 321

* boundary condition: Default

WALL 19 19 34 46 1 12 EAST

U = 0 V = 0 W = 0 RH = 0.005 T = 321

* boundary condition: Default

```

EXIT_P 19 19 31 33 1 6 EAST
U = 0 V = 0 W = 0 P = -2 K = 0.505 D = 0 L = 0.2 T = 300
* boundary condition: Default
WALL 19 19 31 33 7 12 EAST
U = 0 V = 0 W = 0 RH = 0.005 T = 321
* boundary condition: Default
WALL 19 19 18 30 1 12 EAST
U = 0 V = 0 W = 0 RH = 0.005 T = 322
* boundary condition: Default
EXIT_P 19 19 15 17 1 6 EAST
U = 0 V = 0 W = 0 P = -1 K = 0.505 D = 0 L = 0.2 T = 300
* boundary condition: Default
WALL 19 19 15 17 7 12 EAST
U = 0 V = 0 W = 0 RH = 0.005 T = 322
* boundary condition: Default
WALL 19 19 1 14 1 12 EAST
U = 0 V = 0 W = 0 RH = 0.0001 EM = 0
* boundary condition: Default
WALL 1 19 1 1 1 12 SOUTH
U = 0 V = 0 W = 0 RH = 0.0001 EM = 0
* boundary condition: Default
WALL 1 19 65 65 1 12 NORTH
U = 0 V = 0 W = 0 RH = 0.0001 EM = 0
* boundary condition: Default
SYMMETRY 1 19 1 65 1 1 LOW
* boundary condition: Default
EXIT_P 6 14 63 65 12 12 HIGH
U = 0 V = 0 W = 0 P = -5 K = 0.505 D = 0 L = 0.2 T = 300
* boundary condition: Default
WALL 1 5 63 65 12 12 HIGH
U = 0 V = 0 W = 0 RH = 0.005 T = 321
* boundary condition: Default
WALL 15 19 63 65 12 12 HIGH
U = 0 V = 0 W = 0 RH = 0.005 T = 321
* boundary condition: Default
WALL 1 19 50 62 12 12 HIGH
U = 0 V = 0 W = 0 RH = 0.005 T = 321
* boundary condition: Default
EXIT_P 6 14 47 49 12 12 HIGH
U = 0 V = 0 W = 0 P = -3.3 K = 0.505 D = 0 L = 0.2 T = 300
* boundary condition: Default
WALL 1 5 47 49 12 12 HIGH
U = 0 V = 0 W = 0 RH = 0.005 T = 321
* boundary condition: Default
WALL 15 19 47 49 12 12 HIGH
U = 0 V = 0 W = 0 RH = 0.005 T = 321
* boundary condition: Default
WALL 1 19 34 46 12 12 HIGH
U = 0 V = 0 W = 0 RH = 0.005 T = 321
* boundary condition: Default
WALL 15 19 31 33 12 12 HIGH
U = 0 V = 0 W = 0 RH = 0.005 T = 321
* boundary condition: Default
EXIT_P 6 14 31 33 12 12 HIGH
U = 0 V = 0 W = 0 P = -2 K = 0.505 D = 0 L = 0.2 T = 300
* boundary condition: Default
WALL 1 5 31 33 12 12 HIGH
U = 0 V = 0 W = 0 RH = 0.005 T = 321
* boundary condition: Default
WALL 1 19 18 30 12 12 HIGH
U = 0 V = 0 W = 0 RH = 0.005 T = 322
* boundary condition: Default
WALL 15 19 15 17 12 12 HIGH
U = 0 V = 0 W = 0 RH = 0.005 T = 322
* boundary condition: Default
EXIT_P 6 14 15 17 12 12 HIGH
U = 0 V = 0 W = 0 P = -1.3 K = 0.505 D = 0 L = 0.2 T = 300
* boundary condition: Default
WALL 1 5 15 17 12 12 HIGH
U = 0 V = 0 W = 0 RH = 0.005 T = 322

```

```

* boundary condition: Default
WALL 1 19 1 14 12 12 HIGH
U = 0 V = 0 W = 0 RH = 0.0001 EM = 0
END
*
INITIAL_CONDITIONS
U = 1 V = 0 W = 0 P = 0 T = 300 K = 0.505 D = 0 L = 0.2
RESTART FROM jkh1-intf.AUR
END
*
***** Solve *****
*
SOLUTION_CONTROL
ALGORITHM SIMPLEX
S_SCHEME UPWIND U V W
S_SCHEME UPWIND RHO
S_SCHEME UPWIND K D
S_SCHEME UPWIND H
ITERATIONS 2000
C_ITERATIONS 1
SOLVER WHOLE_I U V W
SOLVER CG PP
SOLVER WHOLE_I K D
SOLVER CG H
S_ITERATIONS 5 U V W
S_ITERATIONS 500 PP
S_ITERATIONS 5 K D
S_ITERATIONS 500 H
INERTIAL_FACTOR 0.9 U V W
INERTIAL_FACTOR 0.8 K D
INERTIAL_FACTOR 0.7 H
RELAX 0.3 P RHO T VIS
RELAX 0.5 RAD
MINVAL -1e+020 U V W
MINVAL -1 P
MINVAL 1e-006 RHO
MINVAL 1e-010 T VIS
MINVAL 1e-010 K D
MINVAL -1e+020 H
MAXVAL 1e+020 U V W
MAXVAL 1e+020 P RHO
MAXVAL 5000 T
MAXVAL 100 VIS
MAXVAL 1e+020 K D
MAXVAL 1e+020 H
END
*
OUTPUT
PLOT3D ON FORMATTED
SCALAR_FILE 1 P T TOT_P - -
DTF ON
DTF_SCALARS P T TOT_P
DIAGNOSTICS OFF
RESTART_SAVE 5000
END
INTERNAL
CROSS_TERMS OFF K D
END

```

• Example of data input for experiment of aerodynamic performance – exterior model

```

TITLE ' Joglo kitri large version - exterior '
*
*
*
*
***** Model *****
*
*
MODEL jkh
*
GEOMETRY
  GRID 3D BFC
  USE GRID FROM jkh.DTF DTF
* Cell Types
* name: Default
  BLOCK 1 9 5 13 1 24
* name: Default
  BLOCK 1 9 1 4 1 24
  DOMAIN 2
* name: Default
  BLOCK 29 60 1 4 1 9
* name: Default
  BLOCK 29 60 1 4 10 33
* name: Default
  BLOCK 29 60 1 4 34 42
* name: Default
  BLOCK 29 60 5 13 34 42
* name: Default
  BLOCK 29 60 5 13 1 9
* name: Default
  BLOCK 29 60 5 13 10 33
END
*
PROBLEM_TYPE
  SOLVE FLOW TURBULENCE
* Steady flow
END
*
PROPERTIES
  DENSITY CONSTANT 1.177
  VISCOSITY CONSTANT_KINEMATIC 1.57e-005
END
*
MODELS
  TURBULENCE_MODEL KE
END
*
*** Boundary Conditions ***
*
BOUNDARY_CONDITIONS
* Gravity boundary condition specified
  GRAV_X 0
  GRAV_Y -9.8
  GRAV_Z 0
  RHOREF AUTO
* boundary condition: Default
  INTERFACE 1 1 14 37 1 24 WEST
* boundary condition: Default
  INTERFACE 1 9 14 37 1 1 LOW
* boundary condition: Default
  INTERFACE 1 9 14 37 24 24 HIGH
* boundary condition: Default
  SYMMETRY 9 9 14 37 1 24 EAST
* boundary condition: Default
  WALL 1 9 14 14 1 24 SOUTH

```

```

U = 0 V = 0 W = 0 RH = 0.005
* boundary condition: Default
  SYMMETRY 1 9 37 37 1 24  NORTH
  DOMAIN 2
* boundary condition: Default
  INTERFACE 60 60 14 37 1 9  EAST
* boundary condition: Default
  INTERFACE 60 60 14 37 10 33  EAST
* boundary condition: Default
  INTERFACE 60 60 14 37 34 42  EAST
* boundary condition: Default
  WALL 28 28 1 4 1 9  EAST
  U = 0 V = 0 W = 0 RH = 0.0001
* boundary condition: Default
  INLET 1 1 14 37 1 9  WEST
  U = PROF_Y V = 0 W = 0 P = 0 K = 0.505 D = 1.2 L = 0 T = 300
  U 17
  0 0.1 0.25 0.6 0.7 1 2 2.9 3 3.3 4 10 20 30 40 50 60
  0 1.1 1.4 1.75 1.82 1.98 2.36 2.59 2.6 2.67 2.8 3.53 4.2 4.65 4.99
  5.28 5.52
* boundary condition: Default
  WALL 52 60 14 14 1 9  SOUTH
  U = 0 V = 0 W = 0 RH = 0.005
* boundary condition: Default
  WALL 38 51 14 14 1 9  SOUTH
  U = 0 V = 0 W = 0 RH = 0.005
* boundary condition: Default
  WALL 29 37 14 14 1 9  SOUTH
  U = 0 V = 0 W = 0 RH = 0.005
* boundary condition: Default
  WALL 25 28 13 13 1 9  NORTH
  U = 0 V = 0 W = 0 RH = 0.005
  WALL 25 28 14 14 1 9  SOUTH
  U = 0 V = 0 W = 0 RH = 0.005
* boundary condition: Default
  SYMMETRY 1 60 37 37 1 9  NORTH
* boundary condition: Default
  SYMMETRY 1 60 14 37 1 1  LOW
* boundary condition: Default
  INLET 1 1 5 13 1 9  WEST
  U = PROF_Y V = 0 W = 0 P = 0 K = 0.505 D = 1.2 L = 0 T = 300
  U 17
  0 0.1 0.25 0.6 0.7 1 2 2.9 3 3.3 4 10 20 30 40 50 60
  0 1.1 1.4 1.75 1.82 1.98 2.36 2.59 2.6 2.67 2.8 3.53 4.2 4.65 4.99
  5.28 5.52
* boundary condition: Default
  WALL 28 28 5 13 1 9  EAST
  U = 0 V = 0 W = 0 RH = 0.0001
* boundary condition: Default
  SYMMETRY 1 28 5 13 1 1  LOW
* boundary condition: Default
  INLET 1 1 1 4 1 9  WEST
  U = PROF_Y V = 0 W = 0 P = 0 K = 0.505 D = 1.2 L = 0 T = 300
  U 17
  0 0.1 0.25 0.6 0.7 1 2 2.9 3 3.3 4 10 20 30 40 50 60
  0 1.1 1.4 1.75 1.82 1.98 2.36 2.59 2.6 2.67 2.8 3.53 4.2 4.65 4.99
  5.28 5.52
* boundary condition: Default
  WALL 1 28 1 1 1 9  SOUTH
  U = 0 V = 0 W = 0 RH = 0.3
* boundary condition: Default
  SYMMETRY 1 28 1 4 1 1  LOW
* boundary condition: Default
  WALL 28 28 1 4 10 33  EAST
  U = 0 V = 0 W = 0 RH = 0.0001
* boundary condition: Default
  SYMMETRY 1 1 1 4 10 33  WEST
* boundary condition: Default
  WALL 1 28 1 1 10 33  SOUTH
  U = 0 V = 0 W = 0 RH = 0.3

```

```

* boundary condition: Default
  SYMMETRY 1 1 5 13 10 33 WEST
* boundary condition: Default
  WALL 28 28 5 13 10 33 EAST
  U = 0 V = 0 W = 0 RH = 0.0001
* boundary condition: Default
  WALL 25 28 13 13 10 33 NORTH
  U = 0 V = 0 W = 0 RH = 0.005
  WALL 25 28 14 14 10 33 SOUTH
  U = 0 V = 0 W = 0 RH = 0.005
* boundary condition: Default
  SYMMETRY 1 1 14 37 10 33 WEST
* boundary condition: Default
  WALL 52 60 14 14 10 33 SOUTH
  U = 0 V = 0 W = 0 RH = 0.005
* boundary condition: Default
  WALL 38 51 14 14 10 33 SOUTH
  U = 0 V = 0 W = 0 RH = 0.005
* boundary condition: Default
  WALL 29 37 14 14 10 33 SOUTH
  U = 0 V = 0 W = 0 RH = 0.005
* boundary condition: Default
  SYMMETRY 1 60 37 37 10 33 NORTH
* boundary condition: Default
  EXIT_P 1 1 1 4 34 42 WEST
  U = 3.53 V = 0 W = 0 P = 0 K = 0.505 D = 1.2 L = 0 T = 300
* boundary condition: Default
  WALL 28 28 1 4 34 42 EAST
  U = 0 V = 0 W = 0 RH = 0.0001
* boundary condition: Default
  WALL 1 28 1 1 34 42 SOUTH
  U = 0 V = 0 W = 0 RH = 0.3
* boundary condition: Default
  SYMMETRY 1 28 1 4 42 42 HIGH
* boundary condition: Default
  EXIT_P 1 1 5 13 34 42 WEST
  U = 3.53 V = 0 W = 0 P = 0 K = 0.505 D = 1.2 L = 0 T = 300
* boundary condition: Default
  WALL 28 28 5 13 34 42 EAST
  U = 0 V = 0 W = 0 RH = 0.0001
* boundary condition: Default
  WALL 25 28 13 13 34 42 NORTH
  U = 0 V = 0 W = 0 RH = 0.005
  WALL 25 28 14 14 34 42 SOUTH
  U = 0 V = 0 W = 0 RH = 0.005
* boundary condition: Default
  SYMMETRY 1 28 5 13 42 42 HIGH
* boundary condition: Default
  EXIT_P 1 1 14 37 34 42 WEST
  U = 3.53 V = 0 W = 0 P = 0 K = 0.505 D = 1.2 L = 0 T = 300
* boundary condition: Default
  WALL 29 37 14 14 34 42 SOUTH
  U = 0 V = 0 W = 0 RH = 0.005
* boundary condition: Default
  WALL 38 51 14 14 34 42 SOUTH
  U = 0 V = 0 W = 0 RH = 0.005
* boundary condition: Default
  WALL 52 60 14 14 34 42 SOUTH
  U = 0 V = 0 W = 0 RH = 0.005
* boundary condition: Default
  SYMMETRY 1 60 37 37 34 42 NORTH
* boundary condition: Default
  SYMMETRY 1 60 14 37 42 42 HIGH
END
*
INITIAL_CONDITIONS
* Full field initial conditions
  U = 3.53 V = 0 W = 0 P = 0 T = 300 K = 0.505 D = 1.2 L = 0
  RESTART FROM jkh.AUR
END

```

*
***** Solve *****

*
*

SOLUTION_CONTROL
ALGORITHM SIMPLEC
S_SCHEME UPWIND U V W
S_SCHEME UPWIND RHO
S_SCHEME UPWIND K D
ITERATIONS 5000
C_ITERATIONS 1
SOLVER WHOLE_I U V W
SOLVER WHOLE_I PP
SOLVER WHOLE_I K D
S_ITERATIONS 5 U V W
S_ITERATIONS 30 PP
S_ITERATIONS 5 K D
INERTIAL_FACTOR 0.8 U V W
INERTIAL_FACTOR 0.7 K D
RELAX 0.3 P RHO T VIS
MINVAL -1e+020 U V W
MINVAL -1e+020 P
MINVAL 1e-006 RHO
MINVAL 1e-010 T VIS
MINVAL 1e-010 K D
MAXVAL 1e+020 U V W
MAXVAL 1e+020 P RHO
MAXVAL 5000 T
MAXVAL 100 VIS
MAXVAL 1e+020 K D

END

*

OUTPUT

PLOT3D ON FORMATTED
SCALAR_FILE 1 P TOT_P - - -
DTF ON
DTF_SCALARS P TOT_P
DIAGNOSTICS OFF
RESTART_SAVE 5000

END

Table B-1 The Commercial Computational Fluid Dynamics Package (survey in 1996)

Software name	ADINA-F ver 7	ANSYS 5.2 / FLOTRAN	CFD 2000 / STORM	CFD-ACE	CFX 4.1	ESP-r	FIDAP 7.5	FLAIR	PHOENICS 2.1	TASCFlow 2.4	VORTEX-2
1	2	3	4	5	6	7	8	9	10	11	12
Company	ADINA R&D, Inc.	ANSYS, Inc	Adaptive Research	CFD Research Corporation	AEA Technology	ESRU	Fluid Dynamics international	CHAM	CHAM	Advanced Scientific Computing	FLOW/Solve
Platforms											
486 Intel / Pentium	Yes	Yes	Yes	Yes	N/A	N/A	Yes	Yes	Yes	N/A	Yes
Operating systems	Win. NT 3.5	Win. 95 / Win. NT 3.5 up	DOS 5.x up / Win. NT 3.5.1 / Win.95	Win.NT			DOS 5.x up / Win.3.30 up	*	DOS 5.0 up / Win.3.0 up	*	DOS 5.x up / Win 3.31 up
RAM/Disk-spaces	32MB/300MB	16 MB/245 MB	64 MB/500 MB	32 MB/*			*	*	16MB/100MB	*	4MB/8MB
Graphic devices	Win. NT drivers	Win.95 drivers / Win. NT drivers	VESA	*			*	*	Win. Drivers	*	*
Digital Alpha	AXP 3000	Yes	Yes	Yes	Yes		?	?	Yes	Yes	?
Operating systems	OSF1	Digital Unix v3.2 up	OSF 1.2/ needs DEC FORTRAN v 3.4	*	*				*	*	
RAM/Disk-spaces	*	32 MB/293 MB	96 MB/ 500 MB	*	*				*	*	
Graphic devices	*	X11	*	*	*				*	*	

Operating systems	Solaris 2.3 Sun OS 4.1.3	Solaris 2.4 up	Solaris 2.3 needs SunPro FORTRAN v.3.0	Solaris 2.3 up	*	Solaris			*	SunOS	
RAM/Disk-spaces	*	32 MB/293 MB	96MB/500MB	64MB/*	*	8MB/500MB			*		
Graphic devices	*	X11	*	*	*				*		
Convex C Series	Yes	N/A	Yes	?	Yes		?		Yes	Yes	?
Operating systems	*	*	ConvexOS 11.1/needs Convex FORTRAN v 9.1		*				*	Unix	
RAM/Disk-spaces	*	*	96 MB/ 500 MB		*				*	*	
Graphic devices	*	*	*		*				*	*	
Cray Research YMP, C90	Yes	Yes	Yes	Yes	Yes		?		Yes	Yes	?
Operating systems	*	UNICOS	UNICOS 8.0.4/needs CFT77 v.6.0	*	*				*	Unix	
RAM/Disk-spaces	*	*	96MB/500 MB	*	*				*	*	
Graphic devices	*	*	*	*	*				*	*	
Monitor	1024x768	1024x768	1024x768	24 bit graphics board	*	*	*		1024x768	*	1024x768

Price	ADINA-F, ADINA-IN, ADINA-PLOT	ANSYS/ FLOTRAN 5.2	CFD 2000/ STORM	CFD-GEOM 2.0 CFD-ACE 3.0 CFD-VIEW 3.0	CFX 4.1	ESP-r	FIDAP 7.5	FLAIR	PHOENICS 2.1	TACSgrid TASCbob TASCflow3D TASCtool	VORTEX-2
(Not to be published)											
General Features	For analysis of incompressible viscous fluid flow	Multi-purpose fluid flow simulator	Multi-purpose fluid flow simulator	Multi-purpose fluid flow simulator	Multi-purpose fluid flow simulator	Transient Energy Simulator Systems	Multi-purpose fluid flow simulator	Specially designed for HVAC problems	Multi-purpose fluid flow simulator	Multi-purpose fluid flow simulator	Specially designed for HVAC problems
Special Features	Use combination of finite element and finite volume methods (to solve the convection terms)	Design optimization capabilities									
Features for input data preparation											
Automatic / Build up mesh generation tool and refinement	Yes	Yes	Yes	Yes	Yes	Yes	Yes	Yes	Yes	Yes	Yes
Grids/meshes				Multiblock, unstructured/structured meshes							

Capability for complicated geometries (incl. curve, incline lines)	Very high	Very high	Very high	Very high	Very high	Very high	Very high	Very high	No	N/A	High	Yes	No
Maximum mesh size													
Graphical User Interface in geometrical data input	Yes	Yes	Yes	Yes	Yes	Yes	Yes	Yes	N/A	N/A	Yes	Yes	Very primitive
Intuitive, windows look and feel	Yes	Yes	Yes	Yes	Yes	Yes	Yes	Yes	N/A	N/A	Yes	Yes	
Fully interactive menu-driven input	Yes	Yes	Yes	Yes	Yes	Yes	Yes	Yes	N/A	N/A	Yes	Yes	N/A
Context-sensitive fill online help	Yes	Yes	Yes	Yes	Yes	Yes	Yes	Yes	N/A	N/A	Yes	Yes	N/A
Accepts geometrical data from other formats	IGES, DXF	IGES format	IGES format	IGES format	IGES	IGES	IGES	IGES		*	IGES	Yes	N/A
Interface to other software	I-DEAS, Pro/E, PATRAN, AutoCAD Designer	AutoCAD	*	I-DEAS, Pro/E, AutoCAD	I-DEAS(TM) Universal, MSC/PATRAN(TM)	I-DEAS, Pro/E, ANSYS PREP 7, ICEM-CFD	I-DEAS, Pro/E, PATRAN, MSC, ANSYS, NASTRAN	ALGOR, PATRAN, I-DEAS	*	*			*
Export geometrical data	Yes	Yes	Yes	Yes,	Yes	Yes	Yes	Yes	N/A	N/A	Yes	Yes	N/A

Graphical User Interface during data entering for problem definitions	Yes	Yes	Yes	Yes	Yes	Yes	Yes	Yes	Yes	Yes	Yes	Yes	Yes	Yes	Yes	Yes	Yes	Yes	Yes	N/A	
Intuitive, windows look and feel	Yes	Yes	Yes	Yes	Yes	Yes	Yes	Yes	Yes	Yes	Yes	Yes	Yes	Yes	Yes	Yes	Yes	Yes	Yes	Yes	Yes
Fully interactive menu-driven input	Yes	Yes	Yes	Yes	Yes	Yes	Yes	Yes	Yes	Yes	Yes	Yes	Yes	Yes	Yes	Yes	Yes	Yes	Yes	Yes	N/A
Context-sensitive full online help	Yes	Yes	Yes	Yes	Yes	Yes	Yes	Yes	Yes	Yes	Yes	Yes	Yes	Yes	Yes	Yes	Yes	Yes	Yes	Yes	N/A
Other features																					
Types of problem can be solved																					
Natural ventilation systems within buildings	Yes	Yes	Yes	Yes	Yes	Yes	Yes	Yes	Yes	Yes	Yes	Yes	Yes	Yes	Yes	Yes	Yes	Yes	Yes	Yes	Yes

Perspective views with hidden-line removal and light shading	Yes	Yes	Yes	Yes	Yes	Yes	Yes	Yes	Yes	Yes	Yes	Yes
Geometry coloured according to any variables	Yes	Yes	Yes	Yes	Yes	Yes	Yes	Yes	Yes	Yes	Yes	Yes
Animation / slide capabilities	Yes	Yes	Yes	Yes	Yes	Yes	Yes	N/A	Yes	Yes	N/A	
Output files	*	PostScript, TIFF, HPGL	PostScript, HPGL, TARGA, VISTA	PostScript	*	PostScript	PostScript	*	*	PostScripts	*	*
Printers/plotters	*	*	*	*	*	*	*	*	*	*	*	*
Home page	http://world.std.com/~adina	http://www.ansys.com	http://www.psvr.com/adaptive/	http://www.cfdr.com	http://www.aeat.co.uk/cfx/index.html	http://www.strath.ac.uk/Departments/ESRU/esru.htm#Res_Pr	http://www.fdi.com/	http://www.cham.co.uk/	http://www.cham.co.uk/	http://web.idirect.com/~asc/	http://ourworld.compuserve.com/homepages/iowsolve	

Contact person	<p>Dr Jan Walczak ADINA R&D, Inc 71 Elton Avenue, Wauertown, MA 02172, USA</p> <p>Ph.(617)926-51 99 Fx.(617)926-02 38</p> <p>E-mail: info@adina.co m</p>	<p>Dr. Joseph Wong</p> <p>Ph. 61-3-9205-0500 Fx. 61-3-9205-0505</p> <p>E-mail: jwong@worley. com.au</p> <p>or Florence Tan</p> <p>Ph. 65-741-7527 Fx. 65-741-8761</p> <p>E-mail: cadit@singnet.c om.sg</p>	<p>Jon C. Coulter Adaptive Research Division 4960 Corporate Drive, Suite 100-A Huntsville, AL 35805</p> <p>Ph. (205)-830-2620 Fx. (205)-830-2628</p> <p>E-mail: info@arc-cfd.co m</p>	<p>Mr Sukumar</p> <p>E-mail: rs@cfirc.com</p>	<p>Dr David F. Fletcher</p> <p>E-mail: davidf@chem.e ng.usyd.edu.au</p>	<p>Professor J A Clark, Energy Systems Research Unit, Department of Mechanical Engineering, University of Strathclyde, 75 Montrose Street, Glasgow, G1 1XJ</p> <p>Ph.: +44 141 552 4400 X3986 Fax: +44 141 552 8513</p> <p>email: esru@strath.ac. uk</p>	<p>CHAM-Japan 406 Kojimachi Intelligent Bldg 4F, 3-5-4 Kojimachi Chiyoda-ku, Tokyo 102 Japan</p> <p>Ph: +81 352 10 93 56 Fax: +81 352 10 93 90 E-Mail: kyc03652@nift yserve.or.jp</p>	<p>CHAM-Japan 406 Kojimachi Intelligent Bldg 4F, 3-5-4 Kojimachi Chiyoda-ku, Tokyo 102 Japan</p> <p>Ph: +81 352 10 93 56 Fax: +81 352 10 93 90 E-Mail: kyc03652@nift yserve.or.jp</p>	<p>Glenn Smith Advanced Scientific Computing Ltd. 554 Parkside Drive Unit 4 Waterloo, Ontario Canada N2L 5Z4</p> <p>Ph. (519) 886- 8435 Fax. (519) 886- 7580 E-mail: smith@asc.on.c a</p>	<p>Peter L. Spalding E-mail: pls@cham.dem on.co.uk</p>
Sources	Brochures / Internet / E- mail	Brochures / Internet / E- mail	Brochures / Internet / E- mail	software, manuals	Brochures / Internet / E- mail	Brochures / Internet / E- mail	Brochures / Internet / E- mail	Brochures / Internet		

B

BIBLIOGRAPHY

• Books

- _____, 1977, Sejarah Daerah Istimewa Yogyakarta, unknown: Departemen Pendidikan dan Kebudayaan, Pusat Penelitian Sejarah dan Budaya, Proyek Penelitian dan Pencatatan Kebudayaan Daerah.
- ASHRAE Standard 62 -1989, 1989, Ventilation for Acceptable Indoor Air Quality, Atlanta: American Society of Heating, Refrigerating, and Air Conditioning Engineers, Inc.
- ASHRAE, 1989, 1989 ASHRAE Handbook - Fundamental, Atlanta: American Society of Heating, Refrigerating, and Air Conditioning Engineers, Inc.
- CFDRC, 1993, CFD-ACE Theory Manual Version 1.0, Huntsville: CFD Research Corporation.
- CFDRC, 1998, CFD-ACE Command Language Manual, v. 4.0, Huntsville: CFD Research Corporation.
- Awbi, H.B., 1991, Ventilation of Buildings, London: Chapman and Hall.
- Aynsley, R.M., Melbourne, W. and Vickery, B.J., 1977, Architectural Aerodynamics, London: Applied Science Publisher, Ltd.
- Bansal, N.K., Hauser, G. And Minke, G., 1994, Passive Building Design - a Handbook of National Climatic Control, Amsterdam: Elsevier Science B.V.
- Bedford, T., 1984, Basic Principles of Ventilation and Heating, London: H.K. Lewis & Co. Ltd.
- Beng, T.H., 1994, Tropical Architecture and Interiors, Tradition Based Design of Indonesian - Malaysia, Singapore, Thailand, Singapore: Page One Publishing Pte. Ltd.
- Blake, P., 1960, The Master Builders, New York: Knopf.
- Boutet, T.S., 1987, Controlling Air Movement: A Manual for Architects and Builders, New York: McGraw Hill.
- Budihardjo, E., 1990, Architectural Conservation in Bali, Yogyakarta: Gadjah Mada University Press.
- Budihardjo, E., 1994, Percikan Masalah Arsitektur Perumahan Perkotaan, Yogyakarta: Gadjah Mada University Press.
- Dakung, S., 1981, Arsitektur Tradisional Daerah Istimewa Yogyakarta, Yogyakarta: Departemen Pendidikan dan Kebudayaan.
- Dawson, B. and Gillow, J., 1994, The Traditional Architecture of Indonesia, London: Thames and Hudson.
- Drew M.F. and Drew J., 1982, Tropical Architecture in the Dry and Humid Zones, Malabar: Fla.: R.E. Krieger Pub. Co.
- Dumançay, J., 1987, The House in South East Asia, translated and edited by Smithies, M., Singapore: Oxford University.
- Emiliana, Salamun, Taryati, Isyanti, 1992, Kesadaran Budaya tentang Ruang pada Masyarakat di Daerah Istimewa Yogyakarta (Studi Banding mengenai Proses Adaptasi), unknown: Departemen Pendidikan dan Kebudayaan.
- Etheridge, D., Sandberg, M., 1996, Building Ventilation: Theory and Measurement, Chichester: John Wiley and Sons.
- Fanger, P.O., 1970, Thermal Comfort, Analysis and Applications in Environmental Engineering, New York: McGraw-Hill Book Company.
- Fathy, H., 1973, Architecture for the Poor, An Experiment in Rural Egypt, Chicago: The University of Chicago Press.
- Fathy, H., 1986, Natural Energy and Vernacular Architecture, Chicago: The University of Chicago Press.
- Geertz, C., 1960, The Religion of Java, London: The University of Chicago Press.
- Geertz, H., --, Keluarga Jawa, Jakarta: PT Temprint.
- Givoni, B., 1994, Passive and low energy cooling of buildings, New York: Van Nostrand Reinhold.

- Givoni, B., 1998, Climate Considerations in Building and Urban Design, New York: Van Nostrand Reinhold.
- Hamzuri, 1982, Rumah Tradisional Jawa, Jakarta: Departemen Pendidikan dan Kebudayaan.
- Hardjowirogo, M., 1979, Adat Istiadat Jawa, Bandung: Patma.
- Hardjowirogo, M., 1995, Manusia Jawa, Jakarta: PT Gunung Agung.
- Herusatoto, B., 1983, Simbolisme dalam Budaya Jawa, Yogyakarta: PT Hanindita.
- Holm, D., 1983, Energy Conservation in Hot Climate, London: Architectural Press.
- Houghton, E.L., Carruthers, N.B., 1976, Wind Forces on Buildings and Structures - an Introduction, London: Edward Arnold.
- Ismunandar, K., 1993, Joglo - Arsitektur Rumah Tradisional Jawa, Semarang: Dahara Prize.
- Jatman, D., 1997, Psikologi Jawa, Yogyakarta: Yayasan Bentang Budaya.
- Koenigsberger, O., Ingersol, T.G., Mayhew, A., and Szokolay, S.V., 1973, Manual of Tropical Housing and Buildings, Part 1: Climatic Design, Bombay: Orient Longman.
- Koenigsberger, O., Lynn, R., 1965, Roofs in the Warm Humid Tropics, London: Lund Humphries.
- Kukreja, C.P., 1978, Tropical Architecture, New Delhi: Tata McGraw-Hill Publishing Company Limited.
- Lambert, R., Fitzgerald, D., Houghton-Evans, W., 1985, The Importance of Attic Ventilation.
- Lim, B.B.P., ed., 1988, Control of the External Environment of Buildings, Singapore: Singapore University Press.
- Lippsmeier, G., 1969, Building in the Tropics, Munchen: Calwey Verlag.
- Luhan, Mc., 1964, Understanding Media, New York: New American Library.
- Macpherson, R.K., 1960, Physiological Responses to Hot Environments, London: Her Majesty's Stationery Office.
- Mangunwijaya, Y.B., 1980, Pasal-Pasal Penghantar Fisika Bangunan, Jakarta: PT Gramedia.
- Meyer, S. L., 1975, Data Analysis for Scientists and Engineers, New York: John Willey & Sons, Inc.
- McIntyre, D.A., 1980, Indoor Climate, Architectural Science Series, London: Applied Science Publisher Ltd.
- Mills, A.F., 1992, Heat Transfer, Boston: Irwin.
- Mulder, N., 1978, Mysticism and Everyday life in Contemporary Java: Cultural Persistence and Change, Singapore: Singapore University Press.
- Olgyay, V., Olgyay, A., 1969, Design with Climate, Bioclimatic Approach to Architectural Regionalism, Princeton, New Jersey: Princeton University Press.
- Powell, R., 1993, The Asian House, Contemporary Houses of Southeast Asia, Singapore: Select Books Pte. Ltd.
- Prijotomo, J., 1995, Petungan: Sistem Ukuran dalam Arsitektur Jawa, Yogyakarta: Gajah Mada University Press.
- Ray, W.S., 1960, An Introduction to Experimental Design, New York: The Macmillan Company.
- Radford, A.D. and Gero, J.S., 1988, Design by Optimisation in Architecture, Building and Construction, New York: Van Nostrand Reinhold Company.
- Roache, P.J., 1976, Computational Fluid Dynamics, New Mexico: Hermosa Publisher.
- Robinette, G.O., 1983, Landscape Planning for Energy Conservation, New York: Van Nostrand Reinhold Company.
- Ronald, A., 1988, Manusia dan Rumah Jawa, Yogyakarta: Jurusan Teknik Arsitektur, Yogyakarta: Gajah Mada University.
- Ronald, A., Santoso, M., Saragih, S., 1987, Joglo Buildings - A Study of Construction, Proportion and Structure of Royal Houses in Yogyakarta, Yogyakarta: Department of Architecture, Engineering Faculty, Gajah Mada University.
- Ronald, A., 1990, Ciri-ciri Karya Budaya di Balik Tabir Keagungan Rumah Jawa, Yogyakarta: Penerbitan Universitas Atma Jaya Yogyakarta.
- Rudofsky, B., 1981, Architecture without Architects, A Short Introduction to Non-Pedigreed Architecture, 5 ed., London: Academy Editions.
- Schopert, P., Damais, S., Sosrowardoyo, T., 1997, Java Style, Singapore: Editions Didier Millet.
- Schreckenbach, H., (~1984), Construction Technology for Tropical Developing Country, Eschborn: German Agency for Technical Co-operation (GTZ) for the Department of Architecture, University of

- Science and Technology, Kumasi, Ghana.
- Simonds, J.O., 1961, Landscape Architecture: a manual of site and planning design, New York: McGraw-Hill.
 - Snyder, J.C., ed., 1984, Architectural research, New York: Van Nostrand Reinhold.
 - Sukadana, A.A., 1983, Antropo-Ekologi, Surabaya: Airlangga University.
 - Tagg, S., et al., 1994, Webster Concise Encyclopaedia, ver. 1.23, ___: Attica Cybernectis Ltd.
 - Waterson, R., 1990, The Living House - An Anthropology of Architecture in South-East Asia, Singapore: Oxford University Press.
 - Watson, D., ed., 1979, Energy Conservation through Building Designs, An Architectural Record Book, New York: McGraw Hill Book Company.
 - Wiryatmaja, S., 1986, Pengetahuan Bangunan Rumah Tradisional Jawa (Pengetahuan Kalang), Departemen Pendidikan dan Kebudayaan - Direktorat Jendral Kebudayaan, Proyek Penelitian dan Pengkajian Kebudayaan Nusantara (Javanologi).
 - Yuan, L.J., 1987, The Malay House, Rediscovering Malaysia's Indigenous Shelter System, Pulau Pinang, Malaysia: Institut Masyarakat.
 - Yeang, K., 1992, The Architecture of Malaysia, Amsterdam: The Pepin Press.
- **Articles in Anthology.**
- Fazio, P., Bedard, C. and Gowri, K., 1992, Constraint for Generating Building Envelope Design Alternatives, in Kalay, Y.E., ed., 1992, Principles of Computer-Aided Design: Evaluating and Predicting Design Performance, New York: A Wiley-Interscience Publication - John Wiley and Sons, Inc.
 - Goldschmidt, G., 1992, Criteria for Design Evaluation: a Process-Oriented Paradigm, in Kalay, Y.E., ed., 1992, Principles of Computer-Aided Design: Evaluating and Predicting Design Performance, New York: A Wiley-Interscience Publication - John Wiley and Sons, Inc.
 - Manning, P., and Mattar, S., A Preliminary to Deveopment of Expert Systems for Total Design of Entire Buildings, in Kalay, Y.E., ed., 1992, Principles of Computer-Aided Design: Evaluating and Predicting Design Performance, New York: A Wiley-Interscience Publication - John Wiley and Sons, Inc.
 - Schmitt, G., 1992, Design for Performance, in Kalay, Y.E., ed., 1992, Principles of Computer-Aided Design: Evaluating and Predicting Design Performance, New York: A Wiley-Interscience Publication - John Wiley and Sons, Inc.
 - Mitchell, W.J., 1992, The Uses of Inconsistency in Design, in Kalay, Y.E., ed., 1992, Principles of Computer-Aided Design: Evaluating and Predicting Design Performance, New York: A Wiley-Interscience Publication - John Wiley and Sons, Inc.
 - Shibley, R.G., 1984, Quads and Quality: Architectural Inquiry about Energy in Snyder, J.C., ed., 1984, Architectural Research, New York: Van Nostrand Reinhold.
 - Sørensen, P., 1982, A Brief Survey of East and Southeast Asian Prehistoric Houses, in K. G. Izikowitz & P. Sørensen (eds.), The House in East and Southeast Asia: Anthropological and Architectural Aspects, London: Curzon Press Ltd.
 - Wiesel, A., and Becker, R., Integration of Performance Evaluation in Computer-Aided Design, in Kalay, Y.E., ed., 1992, Principles of Computer-Aided Design: Evaluating and Predicting Design Performance, New York: A Wiley-Interscience Publication - John Wiley and Sons, Inc.
- **Proceedings Seminars**
- ____, 1988, The Architecture of Housing, Proceeding of an International Seminar Sponsored by the Aga Khan Awards for Architecture, the African Union of Architects and the Association Architects of Tanzania held in Zanzibar, the United Republic of Tanzania 12-15 Oct. 1988, Aga Khan Award for Architecture.
 - ____, Indoor air '93: proceedings of the 6th International Conference on Indoor Air Quality and Climate, Helsinki, July 4-8, 1993.
 - Aynsley, R., Building Services - Do We See Them as Complementary or Conflicting?, Conference Papers, Australia and New Zealand Third Regional Conference, February 16-18, 1994, Melbourne, Australia.
 - Berger, X. and Deval, J.C., 1985, About Thermal Comfort in Humid Tropical Climates, in Fanger,

- P.O., ed., *Clima 2000, Vol. 4: Indoor Climate*, Copenhagen: VVS Kongres - VVS Messe.
- Department of Public Services of Indonesia, 1990, Technical Guide Proposal for Building Energy Conservation, Workpaper on National Seminar on Building Energy Conservation, Semarang: Universitas Diponegoro.
 - Gagge, A.P., 1985, Thermal Sensation and Comfort in Dry Humid Environments, in Fanger, P.O., ed., *Clima 2000, Vol. 4: Indoor Climate*, Copenhagen: VVS Kongres - VVS Messe.
 - Humphreys, R.M.A., 1996, Thermal Comfort Temperatures World - Wide - The Current Position, in Sayigh, A.A.M., ed., 1996, *Renewable Energy, Energy Efficiency and the Environment, vol.1*, World Renewable Energy Congress, 15-21 June 1996, Denver, Colorado, New York: Elsevier Science, Ltd.
 - Li, Y., 1994, The Role of Computational Fluid Dynamics in Air Flow Design within Buildings, in Proceedings of Third CIBSE Conference, February 15-18, 1994, Melbourne, Australia.
 - McNall, P.E., 1985, Importance of Indoor Air Quality in Fanger, P.O., ed., *Clima 2000: Voll: Future Perspective*, Copenhagen: VVS Kongres - VVS Messe.
 - Rahman, S.A. and Kannan, K.S., 1996, Air Flow and Thermal Comfort Simulation Studies of Wind Ventilated Classrooms in Malaysia, in Sayigh, A.A.M., ed., 1996, *Renewable Energy, Energy Efficiency and the Environment, vol.1*, World Renewable Energy Congress, 15-21 June 1996, Denver, Colorado, New York: Elsevier Science, Ltd.
 - Sonderegger, R.C., 1985, Thermal Modelling of Building as a Design Tool, in Fanger, P.O., ed., *Clima 2000: Voll: Future Perspective*, Copenhagen: VVS Kongres - VVS Messe.
 - Setiadarma, E., Schiler, M. and Koenig, P., 1995, The Climatic Performance of Indonesian Traditional Architecture, a Comparison of Madurese and Javanese Architecture in Howe, R.C., Crowder, B.W., ed., 1995, 20th National Passive Solar Conference, Conference Proceeding, Minneapolis, Minesota, Juli 15-20, 1995, American Solar Energy Society.
 - Sharples, S. and Malama, A., Thermal Performance of Traditional Housing in the Cool Season in Zambia, in Sayigh, A.A.M., ed., 1996, *Renewable Energy, Energy Efficiency and the Environment, vol.1*, World Renewable Energy Congress, 15-21 June 1996, Denver, Colorado, New York: Elsevier Science, Ltd.
 - Silas, J., --, *Arsitektur Jawa atau Rumah Jawa*, Yogyakarta: Proyek Javanologi.
 - Szokolay S.V., Cooling Problems and Responses in Predominantly Overheated Humid Regions. In Bowen A., Clark E., and Labs K. ed., 1981, *Passive Cooling*, International Passive and Hybrid Cooling Conference, Miami Beach 1981, the Publication Office of the American Section of the International Solar Energy Society.
 - Xia, L.J., 1996 The Bioclimatic Features of Vernacular Architecture in China, in Sayigh, A.A.M., ed., 1996, *Renewable Energy, Energy Efficiency and the Environment, vol.1*, World Renewable Energy Congress, 15-21 June 1996, Denver, Colorado, New York: Elsevier Science, Ltd.
- **Journals**
- _____, 1995, Fanger Defeated in CEN - Standard Vote, Building Services, the CIBSE Journal, vol.17, number 7, July 1995, p.5.
 - _____, 1993, Building Services Reports: Will Natural Ventilation Work?, Building Services, (1993), pp.41-42.
 - Baker, A.J., Williams, P.T., Kelso, R.M., Development of a Robust Finite Element CFD Procedure for Predicting Indoor Room Air Motion, Building and Environment, vo.29 (1994), no.3, 261-273.
 - Baker, A.J., Williams, P.T., and Kelso, R.M., 1995, Numerical Calculation of Room Air Motion-Part 1: Math, Physics, and CFD Modeling, ASHRAE Transaction, vol.100, part 2, pp. 514-530.
 - Baker, A.J., Williams, P.T., and Kelso, R.M., 1995, Numerical Calculation of Room Air Motion-Part 3: Three - Dimensional CFD Simulation of a Full - Scale Room Air Experiment, ASHRAE Transaction, vol.100, part 2.
 - Barker, C.T., Yau, R.M.H., Advanced Technology Techniques for More Efficient and Greener Buildings, pp. Barker 28-1 - Barker 28-7.
 - Barozzi, G.S., Imbabi, M.S.E., Nobile, E., Sousa, A.C.M., Physical and Numerical Modelling of a Solar Chimney-based Ventilation System for Buildings, Building and Environment, vol.27 (1992), no.4, pp.433-445.
 - Baskaran, A., Stathopoulos, T., Influence of Computational Parameters on the Evaluation of Wind Effects on the Building Envelope, Building and Environment, vol.27 (1992), no.1, pp.39-49.

- Bristol, A., 1995, Sick Building Syndrome: to Air Condition or Not?, Building Services, vol.17, number 8, August 1995, p.32-33.
- Bergstrom, D.J., Numerical Prediction of a Turbulent Fountain in a Room, ASHRAE Transaction, vol.100, part 2, pp.669-676.
- Chen, Q., Prediction of Room Air Motion by Reynolds-Stress Models, Building and Environment, vol.31 (1996), no.3, pp.233-244.
- Chen, Q., Suter, P., Moser, A., Influence of Air Supply Parameters on Indoor Diffusion, Building and Environment, vol.26 (1991), no.4, pp.417-431.
- Chen, Q., Suter, P., Moser, A., Interpolation Theory and Influence of Boundary Conditions on Room Air Diffusion, Building and Environment, vol.26 (1991), no.4, pp.433-445.
- Clifford, M.J., Everitt, P.J., Clarke, R., Riffat, S.B., Using Computational Fluid Dynamics as a Design Tool for Naturally Ventilated Buildings, Building and Environment, vol.32 (1997), no.4, pp. 305-312.
- Cohran, L., Letter to the Editor, Comment on Paper by Kindangen and Krauss in ASR 39.2, page 113, Architectural Science Review, vol.40, no.1, 1997, pp.33-34.
- Cochran, L.S., Cermak, J.E., Full- and Model -Scale Cladding Pressures on the Texas Tech University Experimental Building, Journal of Wind Engineering and Industrial Aerodynamics, 41-44 (1992), pp. 1589-1600.
- Cook, M.J., Lomas, K.J., 1998, Buoyancy-driven Displacement Ventilation Flows: Evaluation of Two Eddy Viscosity Turbulence Models for Prediction, Proc. CIBSE A: Building Service Engineering Research Technology, 19 (1) 15-21(1998)
- de Vahl, D.G., 1983, Natural Convection of Air in a Square Cavity: A Benchmark numerical Solution, Int. J. Numer. Meth. Fluids 3:249-264.
- Gan, G., Awbi, H.B., Numerical Simulation of the Indoor Environment, Building and Environment, vol. 29 (1994), no.4, pp.449-459.
- Jones, P.J., Whittle, G.E., Computational Fluid Dynamics for Building Air Flow Prediction - Current Status and Capabilities, Building and Environment, vol.27 (1992), no.3, pp. 321-338.
- Jouni, D.B., Said, M.N., Plett, E.G., Measurement of Room Air Distribution in a Ventilated Office Environment, Building and Environment, vol.29 (1994), no.4, pp.511-521.
- Karyono, T.H., 1995, Thermal Comfort for the Indonesian Workers in Jakarta, Building Research Information, Nov./Dec. 1995, vol.23, no.6, p.317-323.
- Kato, S., Murakami, S., Kondo, Y., 1994, Numerical Simulation of Two - Dimensional Room Air flow with and without Buoyancy by Means of ASM, in Geshuiler, M., 1994, ASHRAE Transactions 1994, Part 1, pp.238-255.
- Kent, J.H., Air Conditioning Modelling by Computational Fluid Dynamics, Architectural Science Review, vol.37 (1994), no.3, pp.103-113.
- Kindangen, J. and Krauss, G., Investigation of Natural Ventilation with Computational Fluid Dynamics, a Comparison Study with Wind Tunnel Results, Architecture Science Review, vol.39 (1996), no.1 , p.113-120.
- Kindangen, J., Krauss, G., and Depecker, P., Effects of Roof Shapes on Wind-Induced Air Motion Inside Buildings, Building and Environment, Vol.32 (1997), No.1, pp.1-11.
- Knappmiller, K.D., Computational Determination of the Behaviour of a Cold Air Ceiling Jet in a Room with a Plume, ASHRAE Transaction, vol.100, part 2, pp.677-696.
- Kolokotroni, M., Saiz, N., Littler, J., Moisture Movement: a Study Using Tracer Gas Techniques and CFD Modelling, vol.13 (1992), no.2, pp.113-117.
- Krishan, A., Jain, K. and Tewari, P., 1996, Indigenous Architecture of Two Indian Deserts and Modern Climatic Responsive Solutions, in Sayigh, A.A.M., ed., 1996, *Renewable Energy, Energy Efficiency and the Environment, vol.1*, World Renewable Energy Congress, 15-21 June 1996, Denver, Colorado, New York: Elsevier Science, Ltd.
- Lakehal, D., 1998, Application of the k-e Model to Flow Over a Building Placed in Different Roughness Sublayers, Journal of Wind Engineering and Industrial Aerodynamics, 73 (1992), pp. 59-77.
- Levitan, M.L., Mehta, K.C., Texas Tech Field Experiments for Wind Loads part I: Building and Pressure measuring System, Journal of Wind Engineering and Industrial Aerodynamics, 41-44 (1992), pp. 1565-1576.
- Levitan, M.L., Mehta, K.C., Texas Tech Field Experiments for Wind Loads part II: Meteorological

- Instrumentation and Terrain Parameters, Journal of Wind Engineering and Industrial Aerodynamics, 41-44 (1992), pp. 1577-1588.
- Li, Y., General Flow and Thermal Boundary Conditions in Indoor Air Flow Simulation, Building and Environment, vol.29 (1994), no.3, pp.275-281.
 - Murakami, S., Kato, S., Ooka, R., Comparisons of Numerical Predictions of Horizontal Non-isothermal Jet in a Room with Three Turbulence Models k-e EVM, ASM, and DSM, ASHRAE Transaction, vol.100, part 2, pp. 697-704.
 - Niu, J., Kooi, J.v.d., Indoor Climate in Rooms with Cooled Ceiling Systems, Building and Environment, vol.29 (1994), no.3, pp.283-290.
 - Okada, H., Ha, Y., Comparison of Wind Tunnel and Full-Scale Pressure Measurement Tests on the Texas Tech Building, Journal of Wind Engineering and Industrial Aerodynamics, 41-44 (1992), pp. 1600-1612.
 - Parmentier, M.H., 1907, L'architecture Interprétée dans les Bas-Reliefs Anciens de Java, Bulletin de l'Ecole Franchise d'Extreme-Orient, vol.VII-1907, p.1-60.
 - Penwarden, A.D., Acceptable Wind Speeds in Town, Building Science, 8, 1973, pp.259-267.
 - Pressman, N., ed., 1994, Architecture and Behaviour, vol.10(1994), no.1.,pp.1-136
 - Pressman, N., ed., 1994, Introduction: Climatic Factors in Urban Design, in Pressman, N., ed., 1994, Architecture and Behaviour, vol.10 (1994), no.1.,pp.1-136.
 - Roy, S., Kelso, R.M., Baker, A.J., An Efficient CFD Algorithm for the Prediction of Contaminant Dispersion in Room Air Motion, ASHRAE Transaction, vol.100, part 2, pp.980-987.
 - Sekhar, S.C., 1995, Higher Space Temperatures and Better Thermal Comfort - a Tropical Analysis, Energy Buildings, vol.23, no.1,pp.63-70.
 - Selvam, R.P., Computation of Pressure on Texas Tech Building, Journal of Wind Engineering and Industrial Aerodynamics, 41-44 (1992), pp. 1619-1627.
 - Shao, L., Sharples, S., Ward, I.C., Building Pressure Coefficient: Application of Three-dimensional CFD Methods to Prediction, Building Service Engineering Research Technology, vol.13 (1992), no.2, pp.107-111.
 - Surry, D., 1991, Pressure Measurements on the Texas Tech. Building: Wind Tunnel Measurements and Comparisons with Full Scale, Journal of Wind Engineering and Industrial Aerodynamics, 38 (1991), pp. 235-247.
 - Williams, P.T., Baker, A.J., 1996, CFD Characterisation of Natural Convection in a Two-Cell Enclosure with a door, in ASHRAE Transactions, vol.100, part 2, pp. 549-564.
 - Williams, P.T., Baker, A.J., 1996, Incompressible Computational Fluid Dynamics and the Continuity Constraint Method for the Three-Dimensional Navier-Stokes Equations, Numerical Heat Transfer, Part B: Fundamentals, 29(2), pp.137-273.
 - Williams, P.T., Baker, A.J., Kelso, R.M., 1996, Numerical Calculation of Room Air Motion - Part 2: The Continuity Constraint Finite Element Method for Three-Dimensional Incompressible Thermal Flows, in ASHRAE Transactions, vol.100, part 1.
 - Williams, P.T., Baker, A.J., Kelso, R.M., 1996, Numerical Calculation of Room Air Motion - Part 3: Three-Dimensional CFD Simulation of a Full-Scale Room Air Experiment, in ASHRAE Transactions, vol.100, part 1.
 - Yamamoto, T., Ensor, D.S., Sparks, L.E., Evaluation of Ventilation Performance for Indoor Space, Building and Environment, vol.29 (1994), no.3, pp.291-296.
- **Unpublished articles and research reports**
- Dwiyanto, D., 1989, Makna Religius Tata Letak Rumah Tradisional Jawa dan Bali, unpublished research report, Faculty of Literature, Gajah Mada University.
 - Pigeaud, T., 1941, Kawroeh Kambeng, unpublished reproduction from a work-paper by Soetasoekarja, M., in Sijam Bé 1864 (Javanese calendar), Mangkoenagaran, Soerakarta.
 - Prasodjo, T., 1988, Relief Rumah pada Candi di Jawa, Sebuah Gambaran Rumah Jawa pada abad IX - XVI Masehi, unpublished research report, Faculty of Literature, Gajah Mada University.
 - Saragih, S., 1990, Unsur Bukaannya dalam Sistem Ventilasi Atap Bangunan Peninggalan Jawa di Yogyakarta (Studi Kasus: Bangunan dengan Atap Lambang Gantung), unpublished research report, Department of Architecture, Faculty of Engineering, Gajah Mada University.
 - Sarwadi, A., 1993, Perubahan Warna yang terjadi pada Rumah Tinggal di Jeron Beteng Keraton

- Sultan Hamengku Buwana – Kotamadya Yogyakarta, unpublished research report, Department of Architecture, Faculty of Engineering, Gajah Mada University.
- Satwiko, P., 1992, The Contribution of Elevated Floor Systems to the Environmental Performance of Houses in Warm Humid Regions, unpublished research report, School of Architecture, Victoria University of Wellington.
 - Satwiko, P., 1994, The Development and Modelling of a Natural Ventilation System for Indonesian Condition- case study of a roof chimney, unpublished Master of Building Science thesis, School of Architecture, Victoria University of Wellington.
 - Sudirman, R., Chotimah, ~1990, Pengukuran Tenaga Radiasi Surya di UGM, unpublished research, Department of Physics, Gajah Mada University.
 - Soetasoekarja, S., 1941, Kawroeh Kambeng, unpublished article.